



PRU Cookbook



Table of contents

1 Case Studies - Introduction	3
1.1 Robotics Control Library	4
1.2 Controlling Eight Servos	4
1.2.1 Problem	4
1.2.2 Solution	4
1.2.3 Discussion	6
1.2.4 PRU register to pin table	6
1.3 Controlling Individual Servos	6
1.3.1 Problem	6
1.3.2 Solution	6
1.4 Controlling More Than Eight Channels	7
1.4.1 Problem	7
1.4.2 Solution	7
1.5 Reading Hardware Encoders	7
1.5.1 Problem	7
1.5.2 Solution	7
1.5.3 eQEP to pin mapping	7
1.5.4 Problem	7
1.5.5 Solution	8
1.6 BeagleLogic - a 14-channel Logic Analyzer	8
1.6.1 Problem	8
1.6.2 Solution	8
1.6.3 Discussion	9
1.7 NeoPixels - 5050 RGB LEDs with Integrated Drivers (Falcon Christmas)	10
1.7.1 Problem	10
1.7.2 Solution	10
1.7.3 Hardware	10
1.7.4 Software Setup	11
1.7.5 Controlling NeoPixels	12
1.8 RGB LED Matrix - No Integrated Drivers (Falcon Christmas)	17
1.8.1 Problem	17
1.8.2 Solution	18
1.8.3 Hardware	18
1.8.4 Software	18
1.8.5 ArduPilot	35
2 Getting Started	37
2.1 Selecting a Beagle	37
2.1.1 Problem	37
2.1.2 Solution	37
2.1.3 Discussion	37
2.2 Installing the Latest OS on Your Bone	41
2.2.1 Problem	41
2.2.2 Solution	41
2.3 Flashing a Micro SD Card	43
2.3.1 Problem	43
2.3.2 Solution	43

2.4	Visual Studio Code IDE	43
2.4.1	Problem	43
2.4.2	Solution	43
2.5	Getting Example Code	45
2.5.1	Problem	45
2.5.2	Solution	46
2.6	Blinking an LED	46
2.6.1	Problem	46
2.6.2	Solution	46
3	Running a Program; Configuring Pins	49
3.1	Getting Example Code	49
3.1.1	Problem	49
3.1.2	Solution	49
3.2	Compiling with clpru and Inkpru	50
3.2.1	Problem	50
3.2.2	Solution	50
3.3	Making sure the PRUs are configured	50
3.3.1	Problem	50
3.3.2	Solution	50
3.4	Compiling and Running	51
3.4.1	Problem	51
3.4.2	Solution	51
3.4.3	Discussion	52
3.5	Stopping and Starting the PRU	53
3.5.1	Problem	53
3.5.2	Solution	53
3.6	The Standard Makefile	53
3.6.1	Problem	53
3.6.2	Solution	53
3.6.3	Discussion	53
3.7	The Linker Command File - am335x_pru.cmd	54
3.7.1	Problem	54
3.7.2	Solution	54
3.7.3	Discussion	56
3.8	Loading Firmware	56
3.8.1	Problem	57
3.8.2	Solution	57
3.8.3	Discussion	57
3.9	Configuring Pins for Controlling Servos	57
3.9.1	Problem	57
3.9.2	Solution	58
3.9.3	Discussion	58
3.10	Configuring Pins for Controlling Encoders	58
3.10.1	Problem	58
3.10.2	Solution	58
3.10.3	Discussion	59
4	Debugging and Benchmarking	61
4.1	Debugging via an LED	61
4.1.1	Problem	61
4.1.2	Solution	61
4.1.3	Discussion	61
4.2	dmesg Hw	61
4.2.1	Problem	61
4.2.2	Solution	62
4.3	dmesg -Hw	62
4.4	prudebug - A Simple Debugger for the PRU	62
4.4.1	Problem	62

4.4.2	Solution	62
4.4.3	Discussion	63
4.5	UART	65
4.5.1	Problem	65
4.5.2	Solution	65
4.5.3	Discussion	67
4.5.4	Details	67
4.5.5	config-pin	68
5	Building Blocks - Applications	81
5.1	Memory Allocation	81
5.1.1	Problem	81
5.1.2	Solution	81
5.1.3	Discussion	83
5.2	Auto Initialization of built-in LED Triggers	86
5.2.1	Problem	86
5.2.2	Solution	86
5.2.3	Discussion	87
5.3	PWM Generator	87
5.3.1	Problem	87
5.3.2	Solution	88
5.3.3	Discussion	89
5.4	Controlling the PWM Frequency	94
5.4.1	Problem	94
5.4.2	Solution	94
5.5	Loop Unrolling for Better Performance	98
5.5.1	Problem	100
5.5.2	Solution	100
5.5.3	Discussion	102
5.6	Making All the Pulses Start at the Same Time	102
5.6.1	Problem	102
5.6.2	Solution	102
5.6.3	Discussion	104
5.7	Adding More Channels via PRU 1	104
5.7.1	Problem	104
5.7.2	Solution	104
5.7.3	Discussion	108
5.8	Synchronizing Two PRUs	108
5.8.1	Problem	108
5.8.2	Solution	108
5.8.3	Discussion	113
5.9	Reading an Input at Regular Intervals	115
5.9.1	Problem	115
5.9.2	Solution	115
5.9.3	Discussion	116
5.10	Analog Wave Generator	116
5.10.1	Problem	116
5.10.2	Solution	116
5.10.3	Discussion	118
5.11	WS2812 (NeoPixel) driver	133
5.11.1	Problem	133
5.11.2	Solution	133
5.11.3	Discussion	134
5.12	Setting NeoPixels to Different Colors	135
5.12.1	Problem	135
5.12.2	Solution	135
5.12.3	Discussion	137
5.13	Controlling Arbitrary LEDs	138

5.13.1 Problem	138
5.13.2 Solution	138
5.13.3 Neo3 Video	139
5.13.4 Discussion	140
5.14 Controlling NeoPixels Through a Kernel Driver	140
5.14.1 Problem	140
5.14.2 Solution	140
5.14.3 Discussion	143
5.15 RGB LED Matrix - No Integrated Drivers	145
5.15.1 Problem	145
5.15.2 Solution	145
5.15.3 Discussion	150
5.16 Compiling and Inserting rmsg_pru	153
5.16.1 Problem	154
5.16.2 Solution	154
5.17 Copyright	154
6 Accessing More I/O	157
6.1 Editing /boot/uEnv.txt to Access the P8 Header on the Black	157
6.1.1 Problem	157
6.1.2 Solution	157
6.2 Accessing gpio	158
6.2.1 Problem	158
6.2.2 Solution	158
6.2.3 Discussion	160
6.2.4 How fast can it go?	160
6.3 Configuring for UIO Instead of RemoteProc	162
6.3.1 Problem	162
6.3.2 Solution	162
6.4 Converting pasm Assembly Code to clpru	163
6.4.1 Problem	163
6.4.2 Solution	163
6.4.3 Discussion	163
7 More Performance	165
7.1 Calling Assembly from C	165
7.1.1 Problem	165
7.1.2 Solution	165
7.1.3 Discussion	167
7.2 Returning a Value from Assembly	168
7.2.1 Problem	168
7.2.2 Solution	168
7.3 Using the Built-In Counter for Timing	169
7.3.1 Problem	169
7.3.2 Solution	169
7.3.3 Discussion	170
7.4 Xout and Xin - Transferring Between PRUs	172
7.4.1 Problem	172
7.4.2 Solution	172
7.4.3 Discussion	174
8 Moving to the BeagleBone AI	177
8.1 Moving from two to four PRUs	177
8.1.1 Problem	177
8.1.2 Solution	177
8.1.3 Discussion	177
8.2 Seeing how pins are configured	180
8.2.1 Problem	180
8.2.2 Solution	180

8.3	Configuring pins on the AI via device trees	181
8.3.1	Problem	181
8.3.2	Solution	181
8.3.3	Discission	181
8.4	Using the PRU pins	182
8.4.1	Problem	182
8.4.2	Solution	182
8.4.3	Discission	183
9	PRU Projects	185

Contributors

- Author: [Mark A. Yoder](#)
 - Book revision: v2.0 beta
-

Outline

A cookbook for programming the PRUs in C using remoteproc and compiling on the Beagle

Chapter 1

Case Studies - Introduction

It's an exciting time to be making projects that use embedded processors. Make:’s [Makers’ Guide to Boards](#) shows many of the options that are available and groups them into different types. *Single board computers* (SBCs) generally run Linux on some sort of [ARM](#) processor. Examples are the BeagleBoard and the Raspberry Pi. Another type is the *microcontroller*, of which the [Arduino](#) is popular.

The SBCs are used because they have an operating system to manage files, I/O, and schedule when things are run, all while possibly talking to the Internet. Microcontrollers shine when things being interfaced require careful timing and can't afford to have an OS preempt an operation.

But what if you have a project that needs the flexibility of an OS and the timing of a microcontroller? This is where the BeagleBoard excels since it has both an ARM processor running Linux and two¹ **P**rogrammable **R**eal-Time **U**nits (PRUs). The PRUs have 32-bit cores which run independently of the ARM processor, therefore they can be programmed to respond quickly to inputs and produce very precisely timed outputs.

There are many [Projects](#) that use the PRU. They are able to do things that can't be done with just a SBC or just a microcontroller. Here we present some case studies that give a high-level view of using the PRUs. In later chapters you will see the details of how they work.

Here we present:

Todo: Switch from LEDscape to FPP

- [Robotics Control Library](#)
- [BeagleLogic](#)
- [NeoPixels - 5050 RGB LEDs with Integrated Drivers \(Falcon Christmas\)](#)
- [RGB LED Matrix \(Falcon Christmas\)](#)
- [simpPRU - A python-like language for programming the PRUs](#)
- [MachineKit](#)
- [BeaglePilot](#)
- [BeagleScope](#)

The following are resources used in this chapter.

Resources

- [PocketBeagle System Reference Manual](#)
- [BeagleBone Black P8 Header Table](#)

¹ Four if you are on the BeagleBone AI

- P8 Header Table from [exploringBB](#)
 - **BeagleBone Black P9 Header Table**
 - P9 Header Table from [exploringBB](#)
 - [BeagleBone AI System Reference Manual](#)
-

1.1 Robotics Control Library

Robotics is an embedded application that often requires both an SBC to control the high-level tasks (such as path planning, line following, communicating with the user) *and* a microcontroller to handle the low-level tasks (such as telling motors how fast to turn, or how to balance in response to an IMU input). The [EduMIP balancing robot](#) demonstrates that by using the PRU, the Blue can handle both the high and low-level tasks without an additional microcontroller. The EduMIP is shown in [Blue balancing](#).

The [Robotics Control Library](#) is a package that is already installed on the Beagle that contains a C library and example/testing programs. It uses the PRU to extend the real-time hardware of the Bone by adding eight additional servo channels and one additional real-time encoder input.

The following examples show how easy it is to use the PRU for robotics.

1.2 Controlling Eight Servos

1.2.1 Problem

You need to control eight servos, but the Bone doesn't have enough pulse width modulation (PWM) channels and you don't want to add hardware.

1.2.2 Solution

The Robotics Control Library provides eight additional PWM channels via the PRU that can be used out of the box.

Note: The I/O pins on the Beagles have a multiplexer that lets you select what I/O appears on a given pin. The Blue has the mux already configured to run these examples. Follow the instructions in [Configuring Pins for Controlling Servos](#) to configure the pins for the Black and the Pocket.

Todo: verify these commands

Just run:

```
bone$ sudo rc_test_servos -f 10 -p 1.5
```

The `-f 10` says to use a frequency of 10 Hz and the `-p 1.5` says to set the position to 1.5. The range of positions is -1.5 to 1.5. Run `rc_test_servos -h` to see all the options.

```
bone$ rc_test_servos -h

Options
-c {channel}  Specify one channel from 1-8.
               Otherwise all channels will be driven equally
-f {hz}      Specify pulse frequency, otherwise 50hz is used
```

(continues on next page)



Fig. 1.1: Blue balancing

(continued from previous page)

```
-p {position} Drive servo to a position between -1.5 & 1.5
-w {width_us} Send pulse width in microseconds (us)
-s {limit} Sweep servo back/forth between +- limit
            Limit can be between 0 & 1.5
-r {ch} Use DSM radio channel {ch} to control servo
-h Print this help message
```

```
sample use to center servo channel 1:
rc_test_servo -c 1 -p 0.0
```

1.2.3 Discussion

The BeagleBone Blue sends these eight outputs to its servo channels. The others use the pins shown in the [PRU register to pin table](#).

1.2.4 PRU register to pin table

PRU pin	Blue pin	Black pin	Pocket pin	AI pin
pru1_r30_8	1	P8_27	P2.35	
pru1_r30_10	2	P8_28	P1.35	P9_42
pru1_r30_9	3	P8_29	P1.02	P8_14
pru1_r30_11	4	P8_30	P1.04	P9_27
pru1_r30_6	5	P8_39		P8_19
pru1_r30_7	6	P8_40		P8_13
pru1_r30_4	7	P8_41		
pru1_r30_5	8	P8_42		P8_18

You can find these details in the

- [PocketBeagle pinout](#)
- [BeagleBone AI PRU pins](#)

By default the PRUs are already loaded with the code needed to run the servos. All you have to do is run the command.

1.3 Controlling Individual Servos

1.3.1 Problem

`rc_test_servos` is nice, but I need to control the servos individually.

1.3.2 Solution

You can modify `rc_test_servos.c`. You'll find it on the bone online at https://git.beagleboard.org/beagleboard/librobotcontrol/-/blob/master/examples/src/rc_test_servos.c

Just past line 250 you'll find a `while` loop that has calls to `rc_servo_send_pulse_normalized(ch, servo_pos)` and `rc_servo_send_pulse_us(ch, width_us)`. The first call sets the pulse width relative to the pulse period; the other sets the width to an absolute time. Use whichever works for you.

1.4 Controlling More Than Eight Channels

1.4.1 Problem

I need more than eight PWM channels, or I need less jitter on the off time.

1.4.2 Solution

This is a more advanced problem and required reprogramming the PRUs. See [PWM Generator](#) for an example.

1.5 Reading Hardware Encoders

1.5.1 Problem

I want to use four encoders to measure four motors, but I only see hardware for three.

1.5.2 Solution

The fourth encoder can be implemented on the PRU. If you run `rc_test_encoders_eqep` on the Blue, you will see the output of encoders E1-E3 which are connected to the eEQP hardware.

```
bone$ rc_test_encoders_eqep

Raw encoder positions
  E1 |      E2 |      E3 |
  0 |      0 |      0 | ^C
```

You can also access these hardware encoders on the Black and Pocket using the pins shown in [eQEP to pin mapping](#).

1.5.3 eQEP to pin mapping

eQEP	Blue pin	Black pin A	Black pin B	AI pin A	AI pin B	Pocket pin A	Pocket pin B
0	E1	P9_42B	P9_27			P1.31	P2.24
1	E2	P8_35	P8_33	P8_35	P8_33	P2.10	
2	E3	P8_12	P8_11	P8_12	P8_11	P2.24	P2.33
2		P8_41	P8_42	P9_19	P9_41		
	E4	P8_16	P8_15			P2.09	P2.18
3				P8_25	P8_24		
3				P9_42	P9_27		

Note: The I/O pins on the Beagles have a multiplexer that lets you select what I/O appears on a given pin. The Blue has the mux already configured to run these examples. Follow the instructions in [Configuring Pins for Controlling Encoders](#) to configure the pins for the Black and the Pocket.

Reading PRU Encoder

1.5.4 Problem

I want to access the PRU encoder.

1.5.5 Solution

The forth encoder is implemented on the PRU and accessed with `sudo rc_test_encoders_pru`

Note: This command needs root permission, so the `sudo` is needed. The default password is `temppwd`.

Here's what you will see

```
bone$ sudo rc_test_encoders_pru
[sudo] password for debian:

Raw encoder position
   E4   |
      0 |^C
```

Note: If you aren't running the Blue you will have to configure the pins as shown in the note above.

1.6 BeagleLogic - a 14-channel Logic Analyzer

1.6.1 Problem

I need a 100Msps, 14-channel logic analyzer

1.6.2 Solution

[BeagleLogic documentation](#) is a 100Msps, 14-channel logic analyzer that runs on the Beagle.

information

BeagleLogic turns your BeagleBone [Black] into a 14-channel, 100Msps Logic Analyzer. Once loaded, it presents itself as a character device node `/dev/beaglelogic`. The core of the logic analyzer is the 'beaglelogic' kernel module that reserves memory for and drives the two Programmable Real-Time Units (PRU) via the remoteproc interface wherein the PRU directly writes logic samples to the System Memory (DDR RAM) at the configured sample rate one-shot or continuously without intervention from the ARM core.

<https://github.com/abhishek-kakkar/BeagleLogic/wiki>

The quickest solution is to get the [no-setup-required image](#). It points to an older image (beaglelogic-stretch-2017-07-13-4gb.img.xz) but should still work.

If you want to be running a newer image, there are instructions on the site for [installing BeagleLogic](#), but I had to do the additional steps in [Installing BeagleLogic](#).

Todo:

- Recheck
-

Listing 1.1: Installing BeagleLogic

```
bone$ git clone https://github.com/abhishek-kakkar/BeagleLogic
bone$ cd BeagleLogic/kernel
bone$ mv beaglelogic-00A0.dts beaglelogic-00A0.dts.orig
```

(continues on next page)

(continued from previous page)

```
bone$ wget https://gist.githubusercontent.com/abhishek-kakkar/
↳0761ef7b10822cff4b3efd194837f49c/raw/
↳eb2cf6cfb59ff5ccb1710dcd7d4a40cc01cfc050/beaglelogic-00A0.dts
bone$ make overlay
bone$ sudo cp beaglelogic-00A0.dtbo /lib/firmware/
bone$ sudo update-initramfs -u -k `uname -r`
bone$ sudo reboot
```

Once the Bone has rebooted, browse to 192.168.7.2:4000 where you'll see [BeagleLogic Data Capture](#). Here you can easily select the sample rate, number of samples, and which pins to sample. Then click *Begin Capture* to capture your data, at up to 100 MHz!

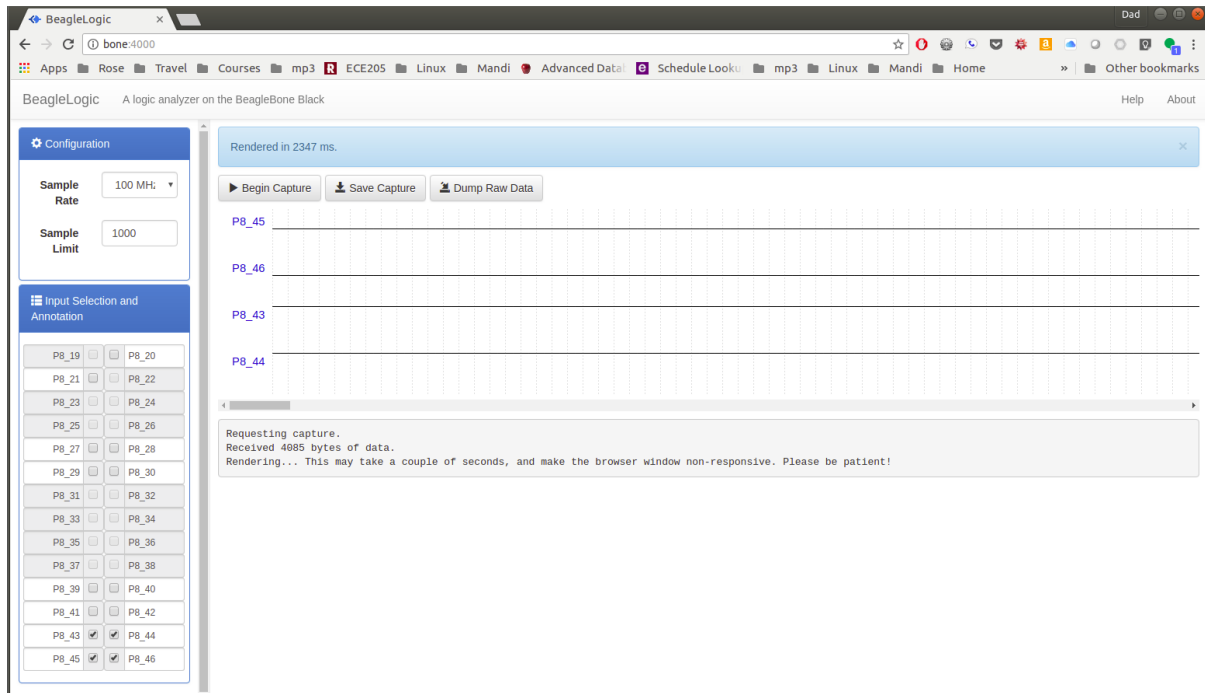

Fig. 1.2: BeagleLogic Data Capture

1.6.3 Discussion

BeagleLogic is a complete system that includes firmware for the PRUs, a kernel module and a web interface that create a powerful 100 MHz logic analyzer on the Bone with no additional hardware needed.

Tip: If you need buffered inputs, consider [BeagleLogic Standalone](#), a turnkey Logic Analyzer built on top of BeagleLogic.

The kernel interface makes it easy to control the PRUs through the command line. For example

```
bone$ dd if=/dev/beaglelogic of=mydump bs=1M count=1
```

will capture a binary dump from the PRUs. The sample rate and number of bits per sample can be controlled through `/sys/`.

```
bone$ cd /sys/devices/virtual/misc/beaglelogic
bone$ ls
```

(continues on next page)

(continued from previous page)

```
buffers      filltestpattern  power      state      uevent
bufunitsize lasterror        samplerate  subsystem
dev          memalloc         sampleunit triggerflags
bone$ *cat samplerate*
1000
bone$ *cat sampleunit*
8bit
```

You can set the sample rate by simply writing to `samplerate`.

```
bone$ echo 100000000 > samplerate
```

`sysfs attributes Reference` has more details on configuring via `sysfs`.

If you run `dmesg -Hw` in another window you can see when a capture is started and stopped.

```
bone$ dmesg -Hw
[Jul25 08:46] misc beaglelogic: capture started with sample rate=100000000.
→Hz, sampleunit=1, triggerflags=0
[ +0.086261] misc beaglelogic: capture session ended
```

BeagleLogic uses the two PRUs to sample at 100Msps. Getting a PRU running at 200Hz to sample at 100Msps is a slick trick. [The Embedded Kitchen](#) has a nice article explaining how the PRUs get this type of performance.

Todo: This is currently broken with the latest version of Falcon Christmas (no F8-B-20.json file)

1.7 NeoPixels - 5050 RGB LEDs with Integrated Drivers (Falcon Christmas)

1.7.1 Problem

You have an [Adafruit NeoPixel LED string](#), [Adafruit NeoPixel LED matrix](#) or any other type of [WS2812 LED](#) and want to light it up.

Todo: Show how to drive `ws2812`'s with FPP.

1.7.2 Solution

If you are driving just one string you can write your own code (See [WS2812 \(NeoPixel\) driver](#)) If you plan to drive multiple strings, then consider [Falcon Christmas \(FPP\)](#). FPP can be used to drive both LEDs with an integrated driver (`neopixels`) or without an integrated driver. Here we'll show you how to set up for the integrated drive and in the next section the no driver LEDs will be show.

1.7.3 Hardware

For this setup we'll wire a single string of NeoPixels to the Beagle. I've attached the black wire on the string to ground on the Beagle and the red wire to a 3.3V pin on the Beagle. The yellow data in line is attached to P1.31 (I'm using a PocketBeagle.).

How did I know to attach to P1.31? The [FalconChristmas git repo](#) (<https://github.com/FalconChristmas/fpp>) has files that tell which pins attach to which port. <https://github.com/FalconChristmas/fpp/blob/master/capes/pb/strings/F8-B-20.json> has a list of 20 ports and where they are connected. Pin P1.31 appears on line 27. It's the 20th entry in the list. You could pick any of the others if you'd rather.

1.7.4 Software Setup

Assuming the PocketBeagle is attached via the USB cable, on your host computer browse to <http://192.168.7.2/> and you will see [Falcon Play Program Control](#).

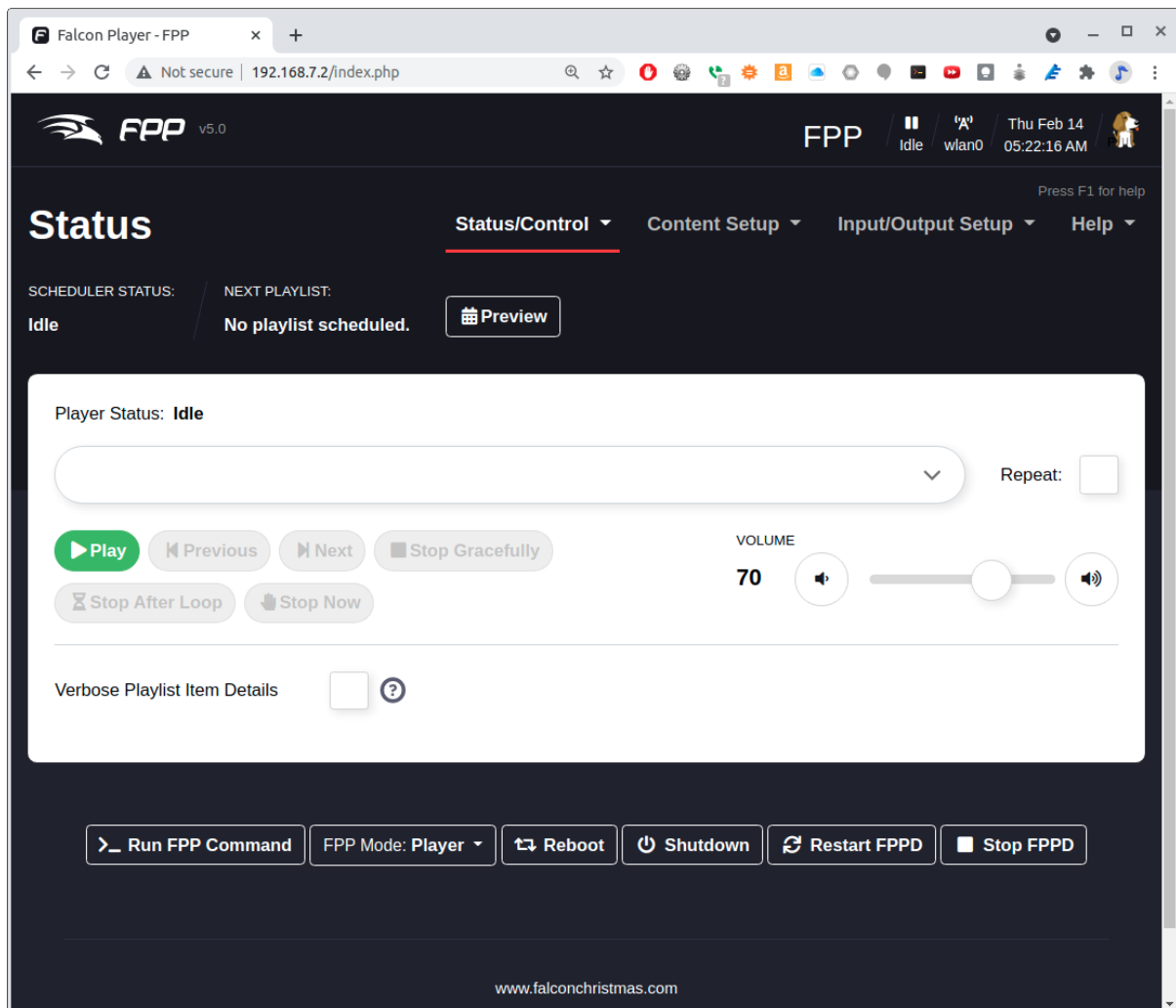

Fig. 1.3: Falcon Play Program Control

You can test the display by first setting up the Channel Outputs and then going to [Display Testing](#). [Selecting Channel Outputs](#) shows where to select Channel Outputs and [Channel Outputs Settings](#) shows which settings to use.

Click on the [Pixel Strings](#) tab. Earlier we noted that [P1.31](#) is attached to port 20. Note that at the bottom of the screen, port 20 has a PIXEL COUNT of 24. We're telling FPP our string has 24 NeoPixels and they are attached to port 2 which in [P1.31](#).

Be sure to check the [Enable String Cape](#).

Next we need to test the display. Select **Display Testing** shown in [Selecting Display Testing](#).

Set the [End Channel](#) to 72. (72 is 3*24) Click [Enable Test Mode](#) and your matrix should light up. Try the different testing patterns shown in [Display Testing Options](#).

Note: Clicking on the -3 will subtract three from the End Channel, which should then display three fewer LEDs which is one NeoPixel. The last of your NeoPixels should go black. This is an easy way to make sure you have

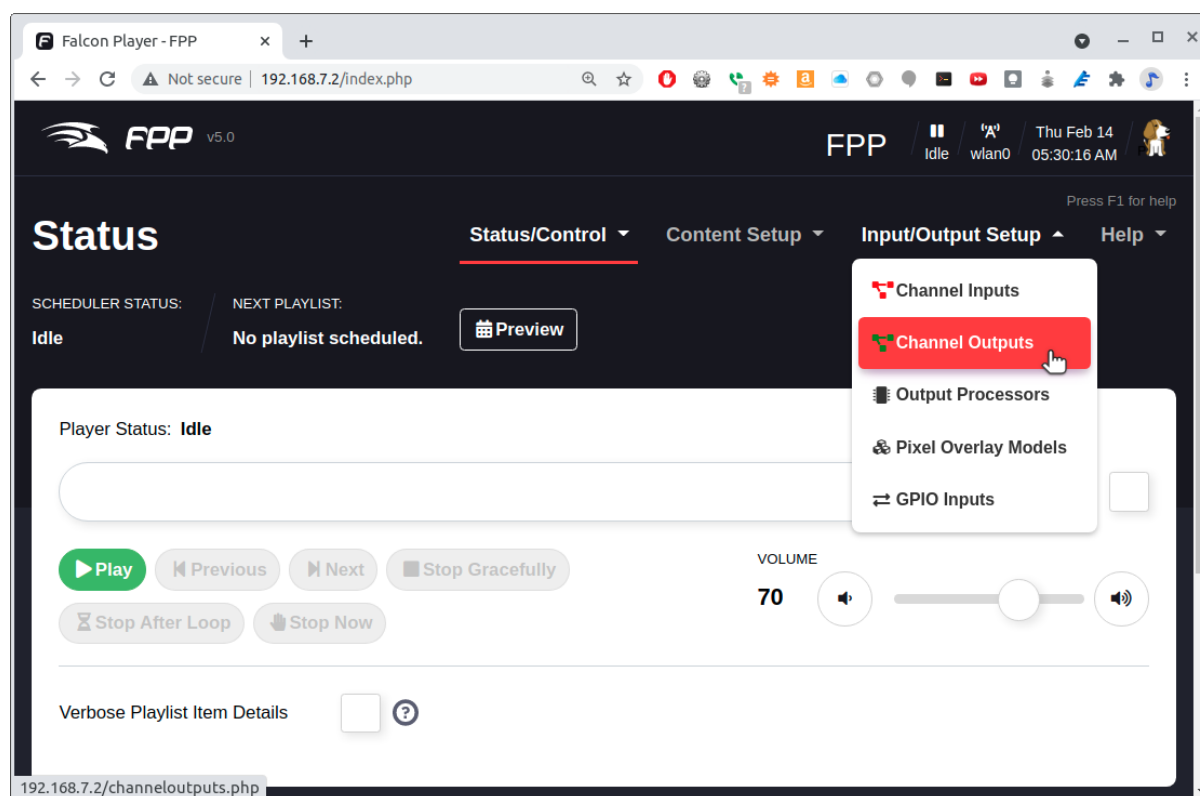

Fig. 1.4: Selecting Channel Outputs

the correct pixel count.

You can control the LED string using the E1.31 protocol. ([https://www.doityourselfchristmas.com/wiki/index.php?title=E1.31_\(Streaming-ACN\)_Protocol](https://www.doityourselfchristmas.com/wiki/index.php?title=E1.31_(Streaming-ACN)_Protocol)) First configure the input channels by going to Channel Inputs as shown in [Going to Channel Inputs](#).

Tell it you have 72 LEDs and enable the input as shown in [Setting Channel Inputs](#).

Finally go to the Status Page as shown in [Watching the status](#).

Now run a program on another computer that generated E1.31 packets.

[Controlling NeoPixels](#) is an example python program.

1.7.5 Controlling NeoPixels

Listing 1.2: e1.31-test.py -Example of generating packets to control the NeoPixels

```

1 #!/usr/bin/env python3
2 # Controls a NeoPixel (WS2812) string via E1.31 and FPP
3 # https://pypi.org/project/sacn/
4 # https://github.com/FalconChristmas/fpp/releases
5 import sacn
6 import time
7
8 # provide an IP-Address to bind to if you are using Windows and want to use
9 sender = sacn.sACNsender("192.168.7.1")

```

(continues on next page)

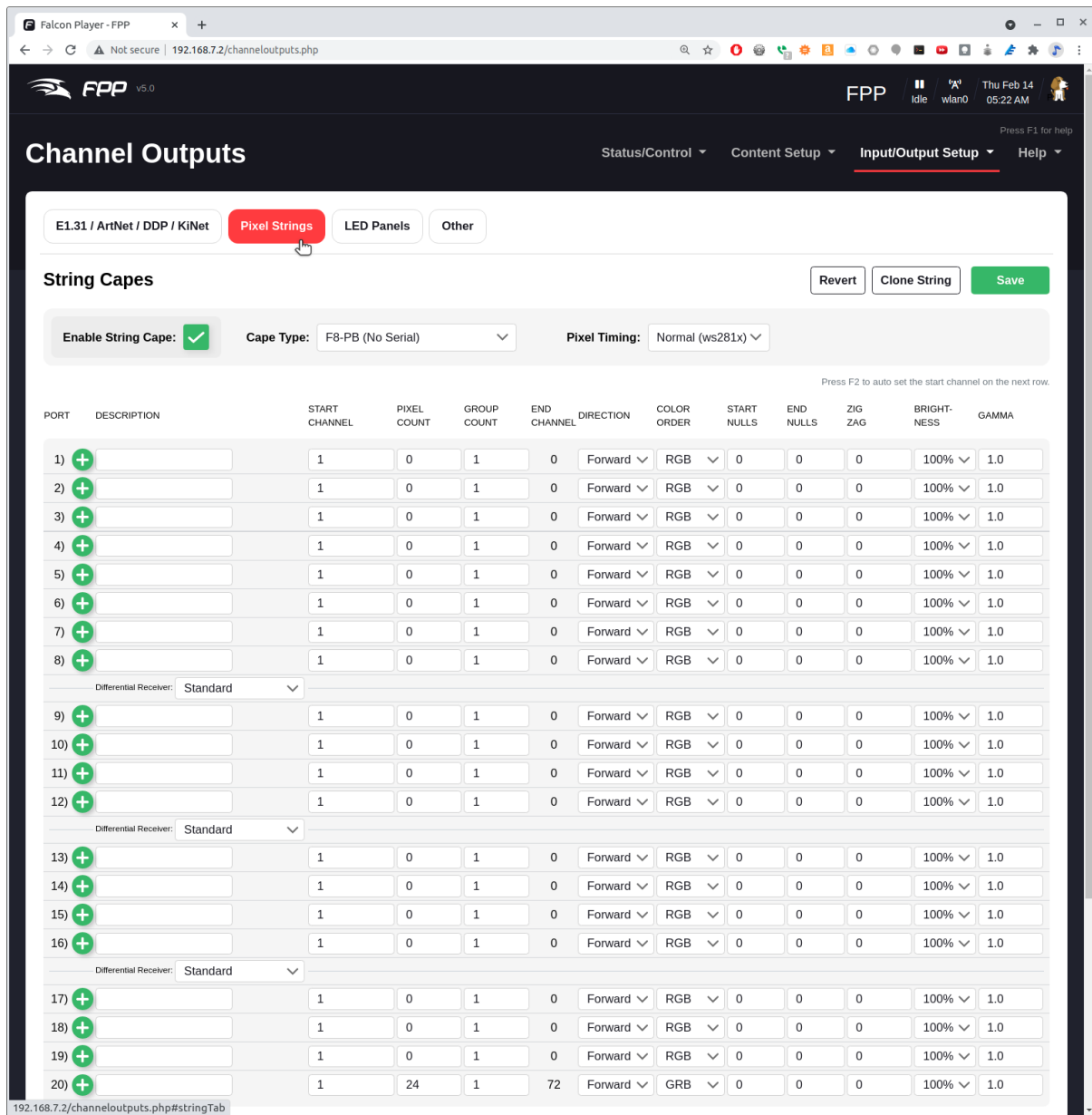

Fig. 1.5: Channel Outputs Settings

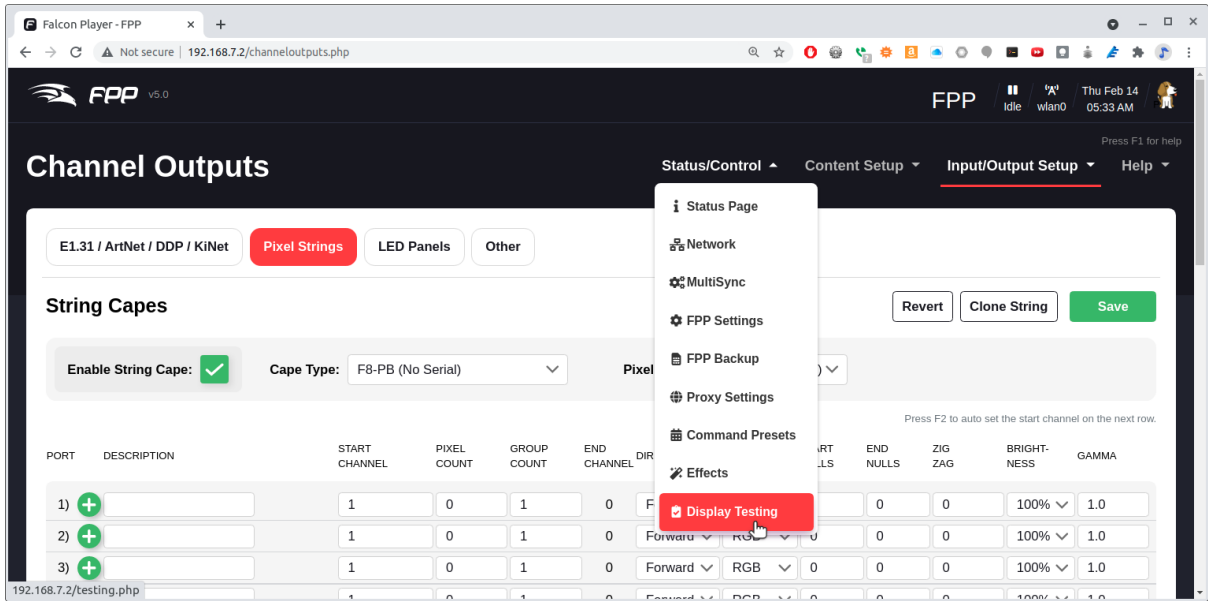

Fig. 1.6: Selecting Display Testing

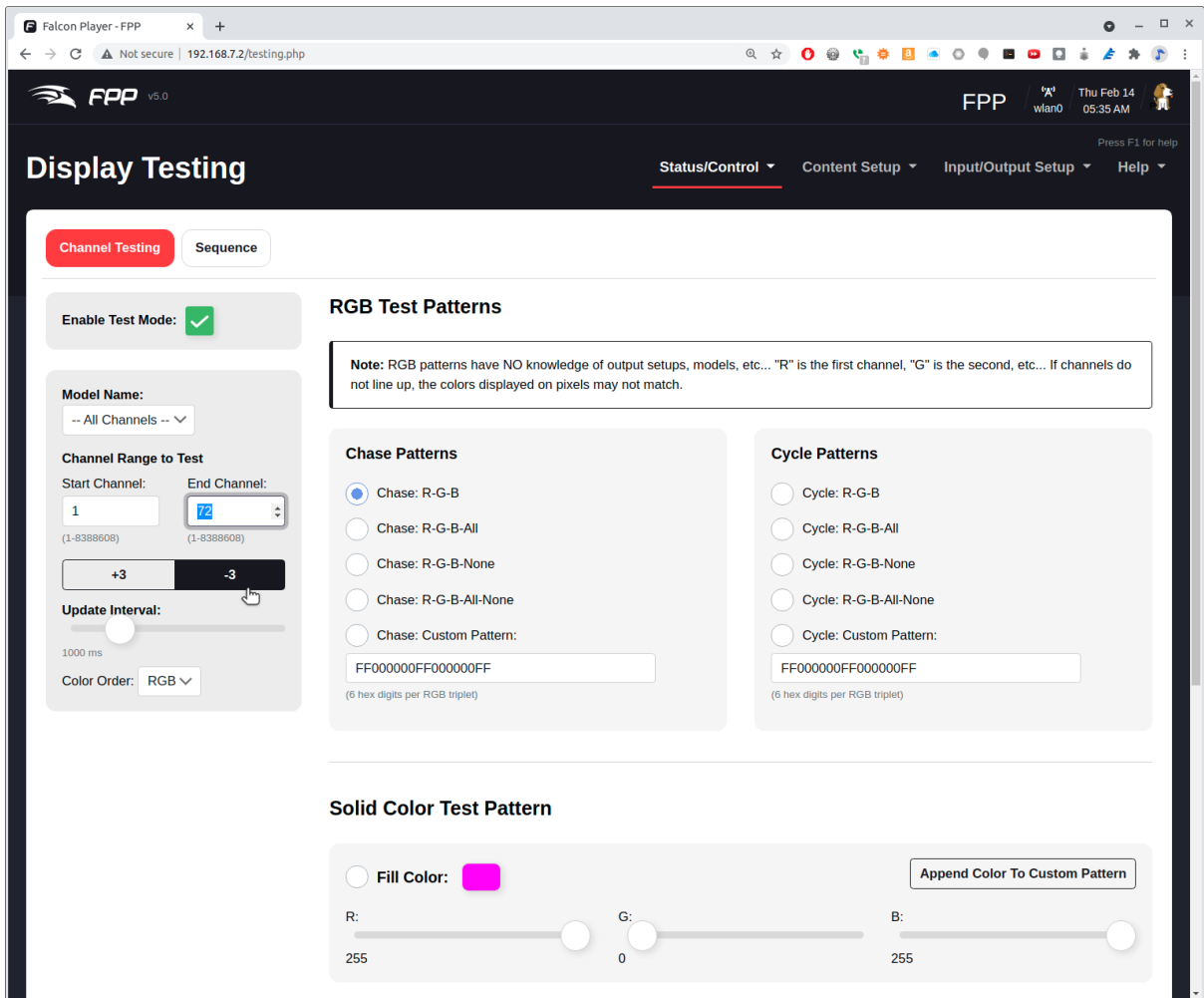

Fig. 1.7: Display Testing Options

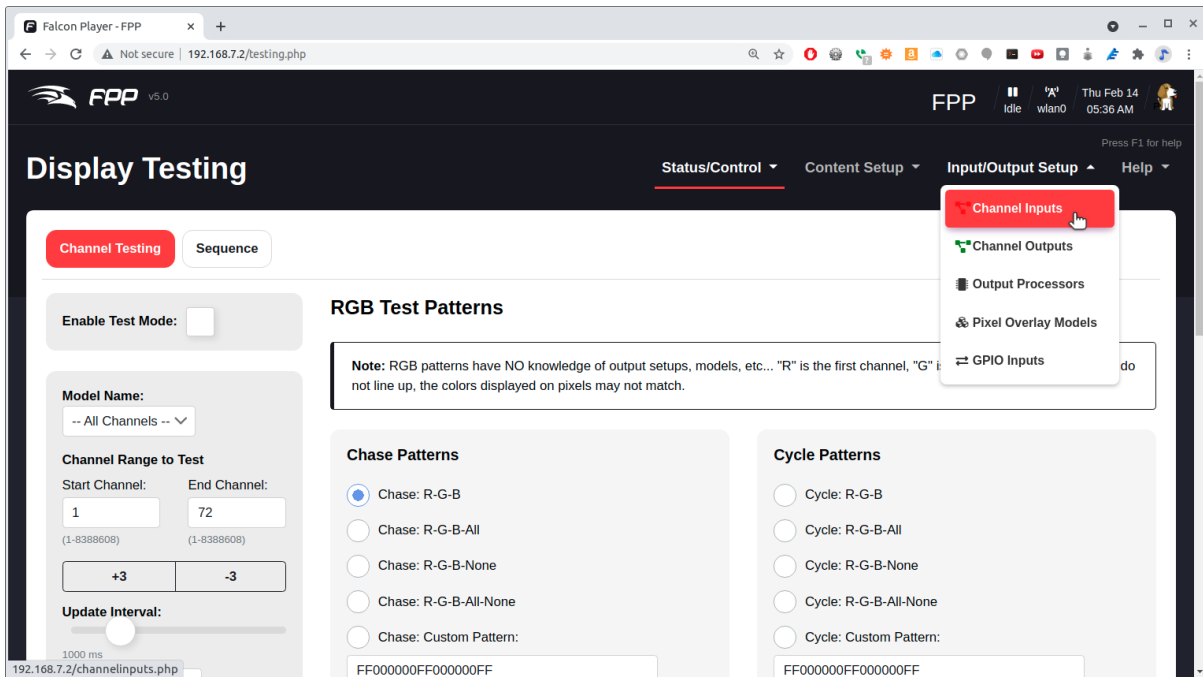

Fig. 1.8: Going to Channel Inputs

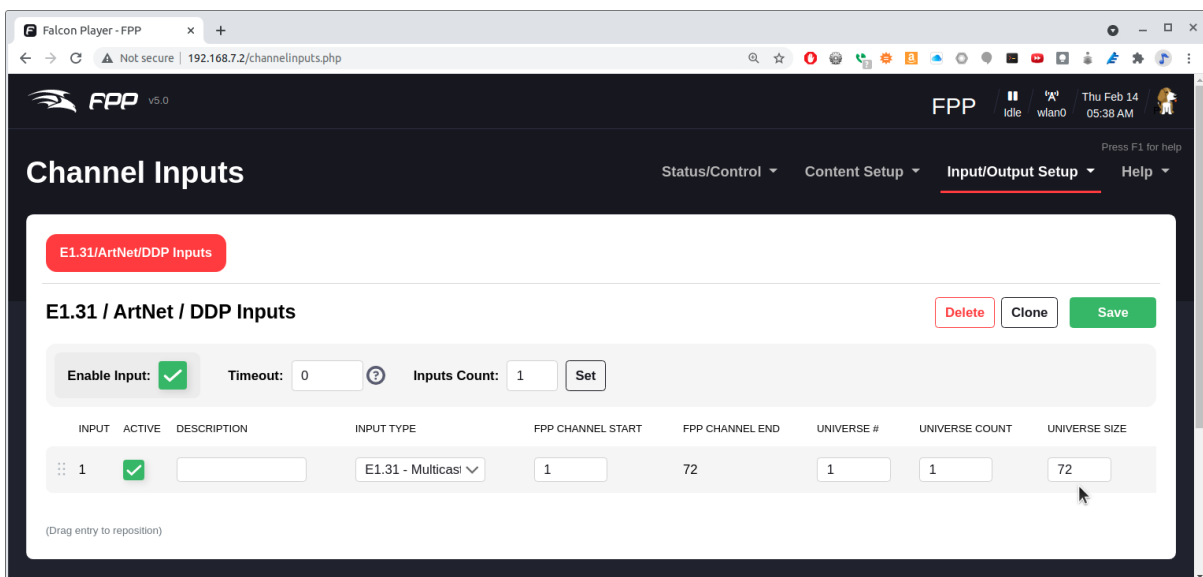

Fig. 1.9: Setting Channel Inputs

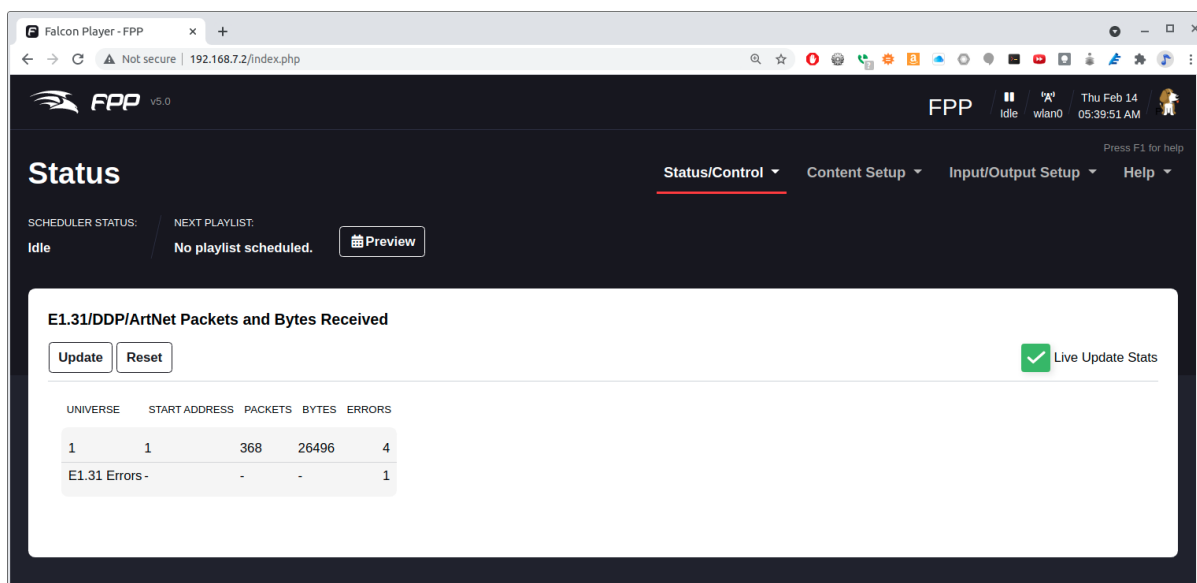

Fig. 1.10: Watching the status

(continued from previous page)

```

10 sender.start() #
   →start the sending thread
11 sender.activate_output(1) # start sending out data in the 1st
   →universe
12 sender[1].multicast = False # set multicast to True
13 sender[1].destination = "192.168.7.2" # or provide unicast information.
14 sender.manual_flush = True # turning off the automatic sending of packets
   # Keep in mind that if multicast is on, unicast is not used
15 LEDcount = 24
16 # Have green fade is as it goes
17 data = []
18
19 for i in range(LEDcount):
20     data.append(0) # Red
21     data.append(i) # Green
22     data.append(0) # Blue
23 sender[1].dmx_data = data
24 sender.flush()
25 time.sleep(0.5)
26
27 # Turn off all LEDs
28 data=[]
29 for i in range(3*LEDcount):
30     data.append(0)
31 sender.flush()
32 sender[1].dmx_data = data
33 time.sleep(0.5)
34
35 # Have red fade in
36 data = []
37 for i in range(LEDcount):
38     data.append(i)
39     data.append(0)
40     data.append(0)
41 sender[1].dmx_data = data
42 sender.flush()
43 time.sleep(0.25)

```

(continues on next page)

(continued from previous page)

```
44
45 # Make LED circle 5 times
46 for j in range(15):
47     for i in range(LEDcount-1):
48         data[3*i+0] = 0
49         data[3*i+1] = 0
50         data[3*i+2] = 0
51         data[3*i+3] = 0
52         data[3*i+4] = 64
53         data[3*i+5] = 0
54         sender[1].dmx_data = data
55         sender.flush()
56         time.sleep(0.02)
57 # Wrap around
58     i = LEDcount-1
59     data[0] = 0
60     data[1] = 64
61     data[2] = 0
62     data[3*i+0] = 0
63     data[3*i+1] = 0
64     data[3*i+2] = 0
65     sender[1].dmx_data = data
66     sender.flush()
67     time.sleep(0.02)
68
69 time.sleep(2) # send the data for 10 seconds
70 sender.stop() # do not forget to stop the sender
```

e1.31-test.py

Todo: document the code

1.8 RGB LED Matrix - No Integrated Drivers (Falcon Christmas)

1.8.1 Problem

You want to use a RGB LED Matrix display that doesn't have integrated drivers such as the [64x32 RGB LED Matrix](#) by Adafruit shown in [Adafruit LED Matrix](#).



Fig. 1.11: Adafruit LED Matrix

1.8.2 Solution

Falcon Christmas makes a software package called *Falcon Player* (FPP) which can drive such displays.

information:

The Falcon Player (FPP) is a lightweight, optimized, feature-rich sequence player designed to run on low-cost SBC's (Single Board Computers). FPP is a software solution that you download and install on hardware which can be purchased from numerous sources around the internet. FPP aims to be controller agnostic, it can talk E1.31, DMX, Pixelnet, and Renard to hardware from multiple hardware vendors, including controller hardware from Falcon Christmas available via COOPs or in the store on FalconChristmas.com.

http://www.falconchristmas.com/wiki/FPP:FAQ#What_is_FPP.3F

1.8.3 Hardware

The Beagle hardware can be either a BeagleBone Black with the *Octoscroller Cape*, or a PocketBeagle with the *PocketScroller LED Panel Cape*. (See to purchase.) *Building and Octoscroller Matrix Display* gives details for using the BeagleBone Black.

PocketBeagle Driving a P5 RGB LED Matrix via the PocketScroller Cape shows how to attach the PocketBeagle to the P5 LED matrix and where to attach the 5V power. If you are going to turn on all the LEDs to full white at the same time you will need at least a 4A supply.

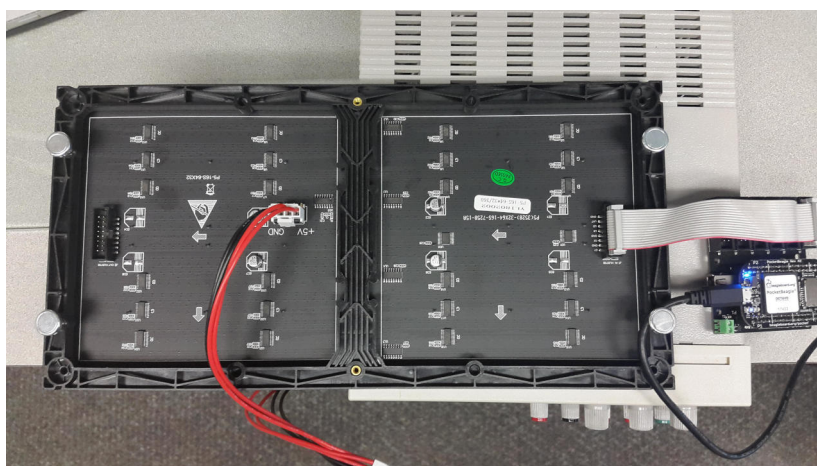

Fig. 1.12: PocketBeagle Driving a P5 RGB LED Matrix via the PocketScroller Cape

1.8.4 Software

The FPP software is most easily installed by downloading the [current FPP release](#), flashing an SD card and booting from it.

Tip: The really brave can install it on a already running image. See details at https://github.com/FalconChristmas/fpp/blob/master/SD/FPP_Install.sh

Assuming the PocketBeagle is attached via the USB cable, on your host computer browse to <http://192.168.7.2/> and you will see *Falcon Play Program Control*.

You can test the display by first setting up the Channel Outputs and then going to *Display Testing*. *Selecting Channel Outputs* shows where to select Channel Outputs and *Channel Outputs Settings* shows which settings to use.

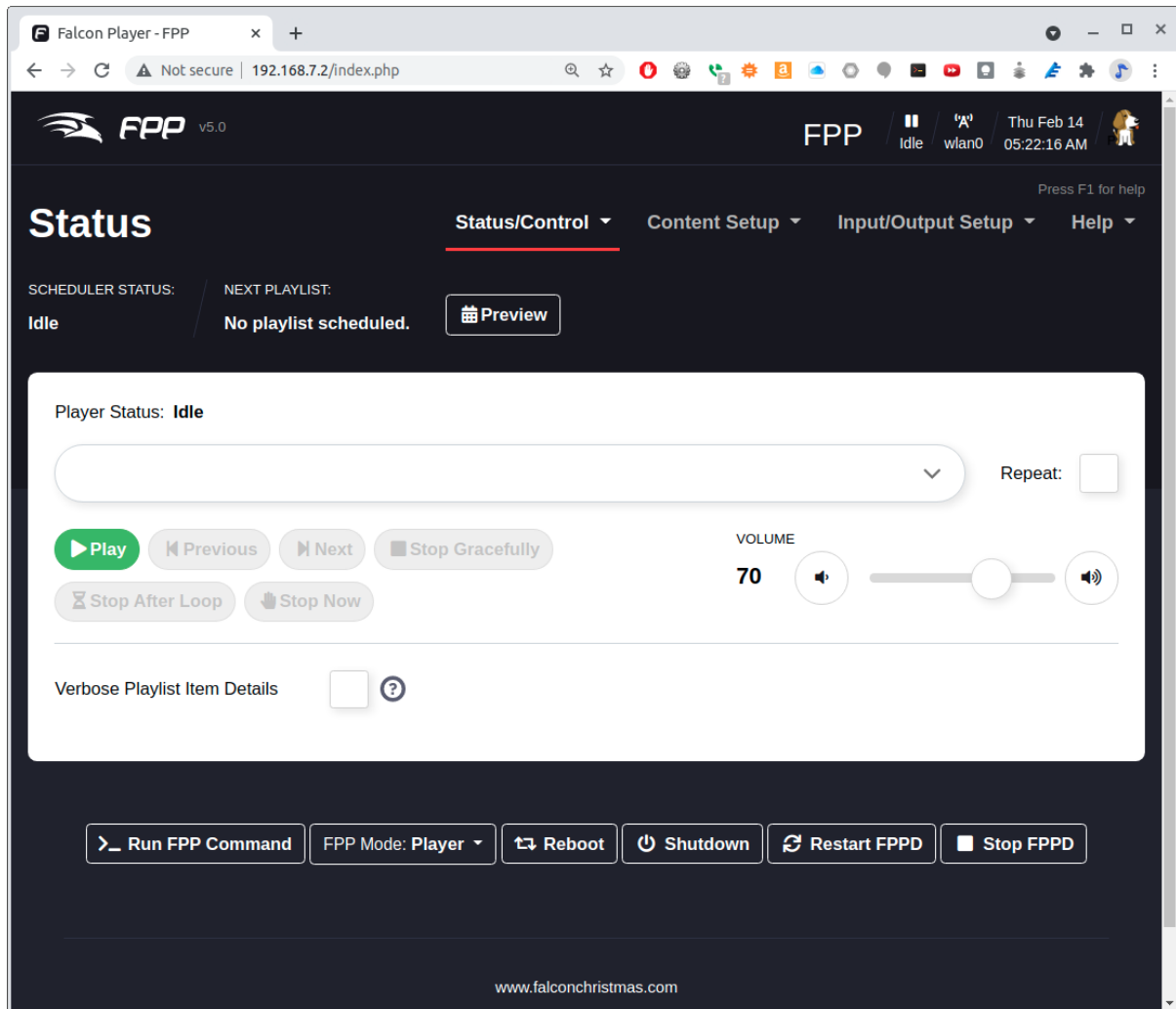

Fig. 1.13: Falcon Play Program Control

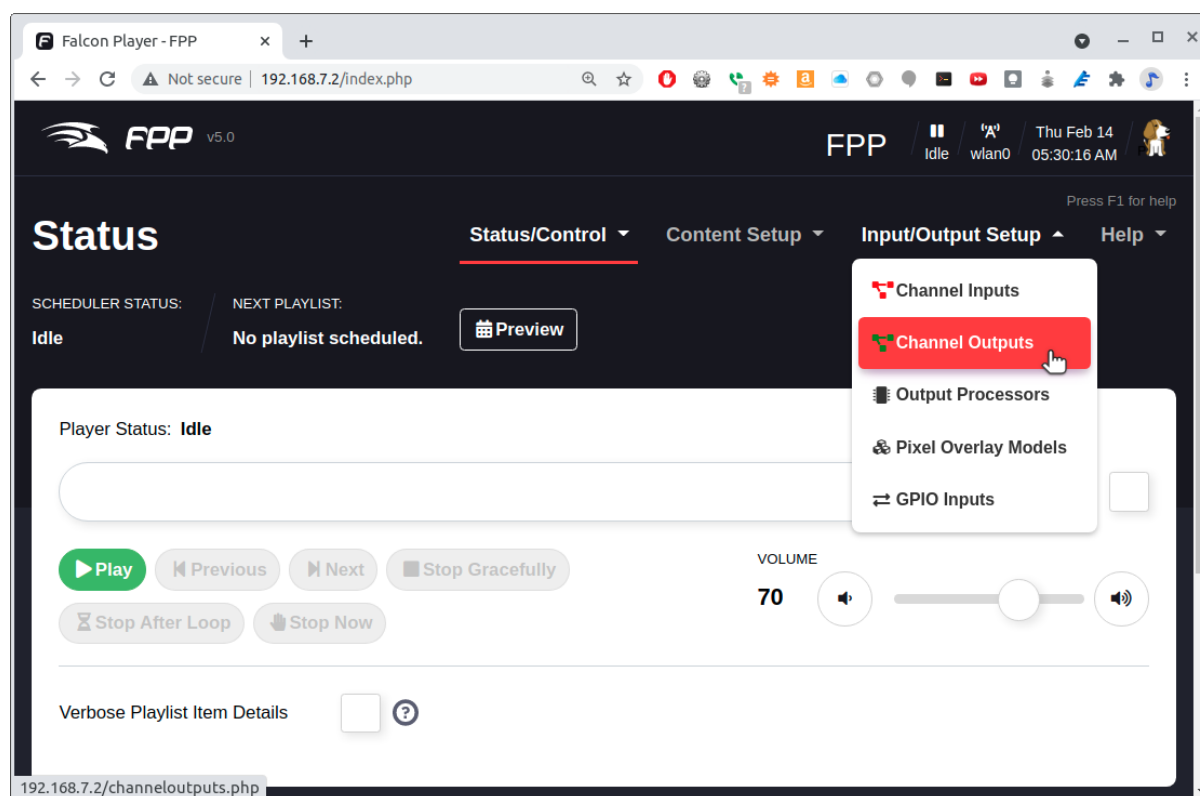

Fig. 1.14: Selecting Channel Outputs

Click on the **LED Panels** tab and then the only changes I made was to select the **Single Panel Size** to be 64x32 and to check the **Enable LED Panel Output**.

Next we need to test the display. Select *Display Testing* shown in [Selecting Display Testing](#).

Set the **End Channel** to **6144**. (6144 is 3*64*32) Click **Enable Test Mode** and your matrix should light up. Try the different testing patterns shown in [Display Testing Options](#).

xLights - Creating Content for the Display

Once you are sure your LED Matrix is working correctly you can program it with a sequence.

information:

xLights is a free and open source program that enables you to design, create and play amazing lighting displays through the use of DMX controllers, E1.31 Ethernet controllers and more.

With it you can layout your display visually then assign effects to the various items throughout your sequence. This can be in time to music (with beat-tracking built into xLights) or just however you like. xLights runs on Windows, OSX and Linux

<https://xlights.org/>

xLights can be installed on your host computer (not the Beagle) by following instructions at <https://xlights.org/releases/>.

Run xLights and you'll see [xLights Setup](#).

```
host$ chmod +x xLights-2021.18-x86_64.AppImage
host$ ./xLights-2021.18-x86_64.AppImage
```

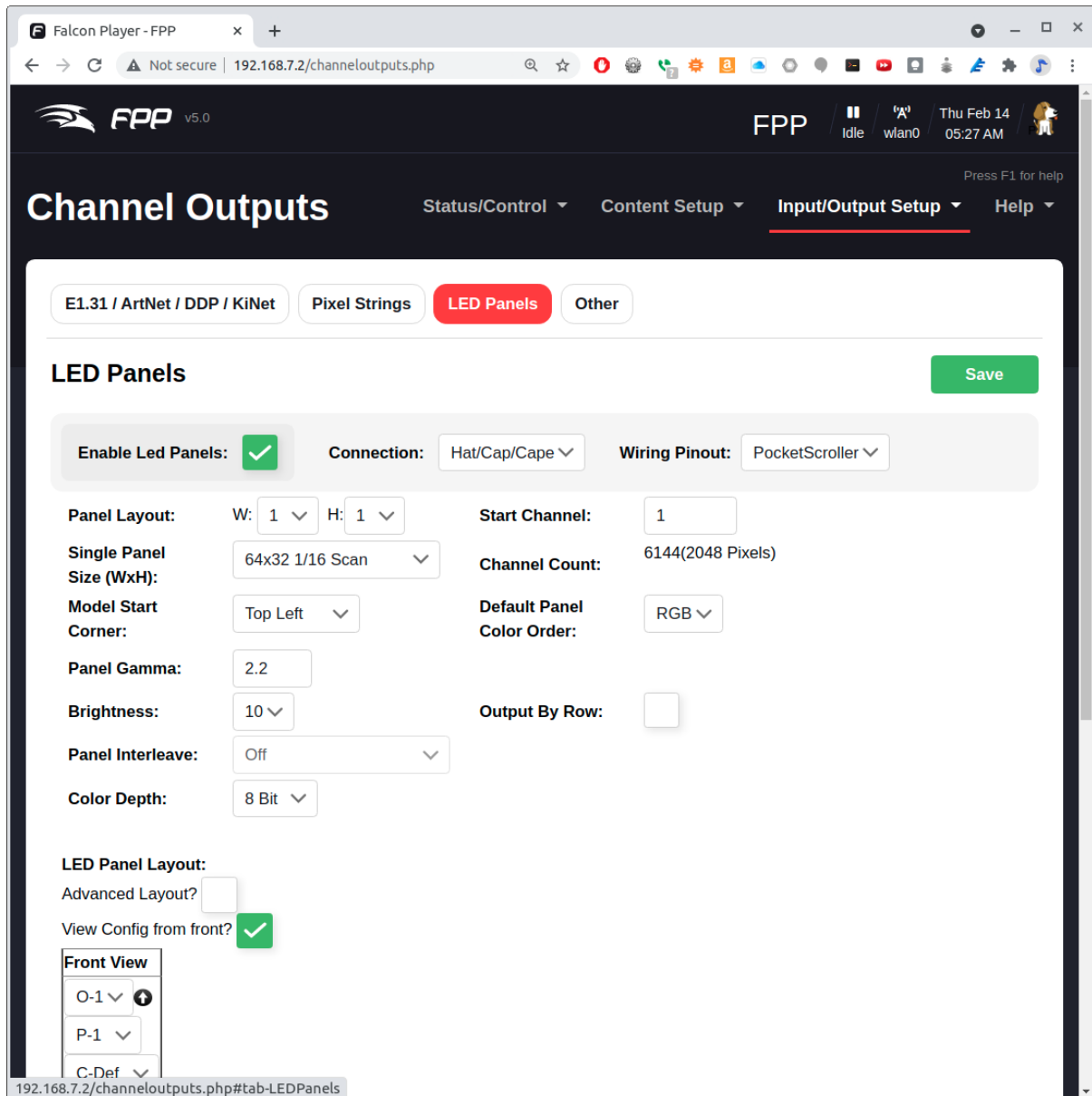

Fig. 1.15: Channel Outputs Settings

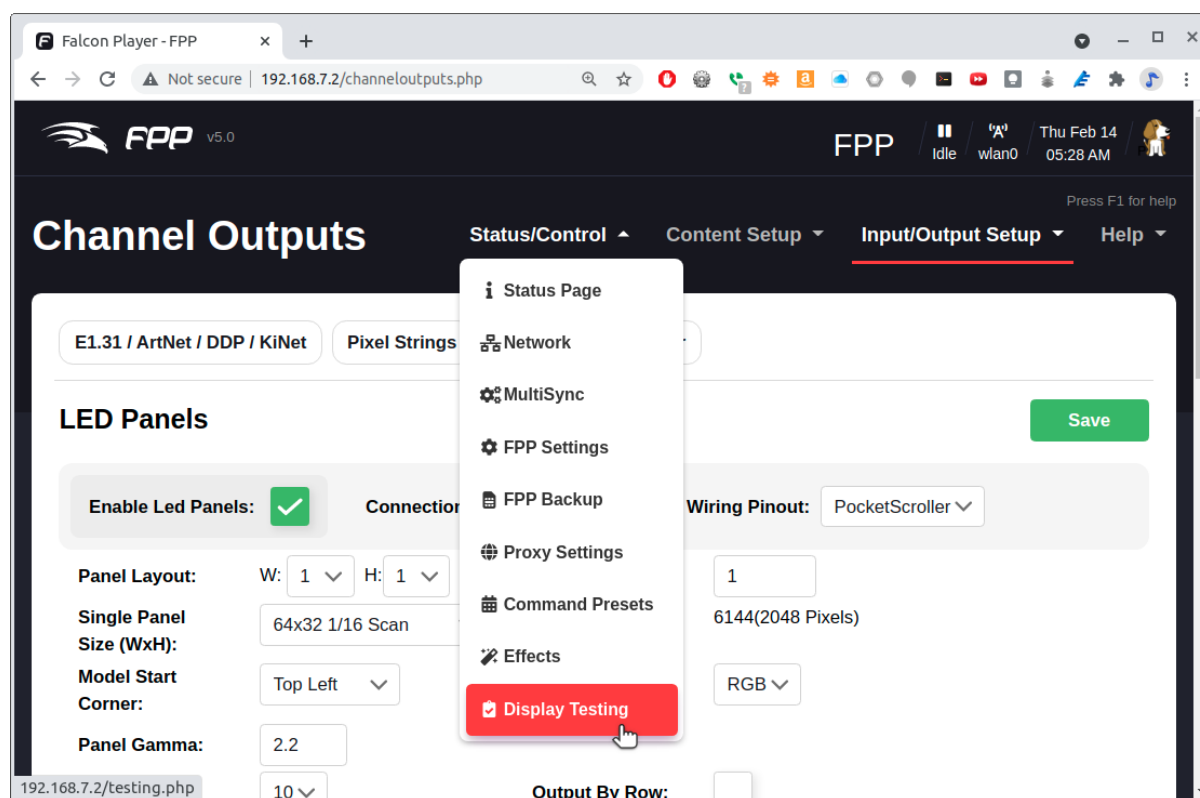

Fig. 1.16: Selecting Display Testing

Todo: update the figures.

We'll walk you through a simple setup to get an animation to display on the RGB Matrix. xLights can use a protocol called E1.31 to send information to the display. Setup xLights by clicking on *Add Ethernet* and entering the values shown in [Setting Up E1.31](#).

The **IP Address** is the Bone's address as seen from the host computer. Each LED is one channel, so one RGB LED is three channels. The P5 board has $3 \times 64 \times 32$ or 6144 channels. These are grouped into universes of 512 channels each. This gives $6144 / 512 = 12$ universes. See the [E.13 documentation](#) for more details.

Your setup should look like [xLights setup for P5 display](#). Click the *Save Setup* button to save.

Next click on the **Layout** tab. Click on the *Matrix* button as shown in [Setting up the Matrix Layout](#), then click on the black area where you want your matrix to appear.

[Layout details for P5 matrix](#) shows the setting to use for the P5 matrix.

All I changed was **# Strings**, **Nodes/String**, **Starting Location** and most importantly, expand **String Properties** and select at **String Type** of **RGB Nodes**. Above the setting you should see that **Start Chan** is 1 and the **End Chan** is 6144, which is the total number of individual LEDs ($3 \times 63 \times 32$). xLights now knows we are working with a P5 matrix, now on to the sequencer.

Now click on the *Sequencer* tab and then click on the **New Sequence** button ([Starting a new sequence](#)).

Then click on **Animation, 20fps (50ms)**, and **Quick Start**. Learning how to do sequences is beyond the scope of this cookbook, however I'll shown you how do simple sequence just to be sure xLights is talking to the Bone.

The screenshot shows the Falcon Player (FPP) v5.0 web interface. The browser address bar shows the URL `192.168.7.2/testing.php`. The page title is "Display Testing". The interface is divided into several sections:

- Channel Testing:** A red button labeled "Channel Testing" and a white button labeled "Sequence".
- Enable Test Mode:** A green checkmark icon indicating that test mode is enabled.
- Model Name:** A dropdown menu currently set to "-- All Channels --".
- Channel Range to Test:**
 - Start Channel: 1 (range 1-8388608)
 - End Channel: 6144 (range 1-8388608)
 - Buttons for "+3" and "-3" to adjust the range.
- Update Interval:** A slider set to 1000 ms.
- Color Order:** A dropdown menu set to "RGB".
- RGB Test Patterns:**
 - Note:** RGB patterns have NO knowledge of output setups, models, etc... "R" is the first channel, "G" is the second, etc... If channels do not line up, the colors displayed on pixels may not match.
 - Chase Patterns:**
 - Chase: R-G-B
 - Chase: R-G-B-All
 - Chase: R-G-B-None
 - Chase: R-G-B-All-None
 - Chase: Custom Pattern:
 - Hex code: `FF000000FF000000FF` (6 hex digits per RGB triplet)
 - Cycle Patterns:**
 - Cycle: R-G-B
 - Cycle: R-G-B-All
 - Cycle: R-G-B-None
 - Cycle: R-G-B-All-None
 - Cycle: Custom Pattern:
 - Hex code: `FF000000FF000000FF` (6 hex digits per RGB triplet)
- Solid Color Test Pattern:**
 - Fill Color:
 - Append Color To Custom Pattern:
 - RGB sliders:
 - R: 255
 - G: 0
 - B: 255

Fig. 1.17: Display Testing Options

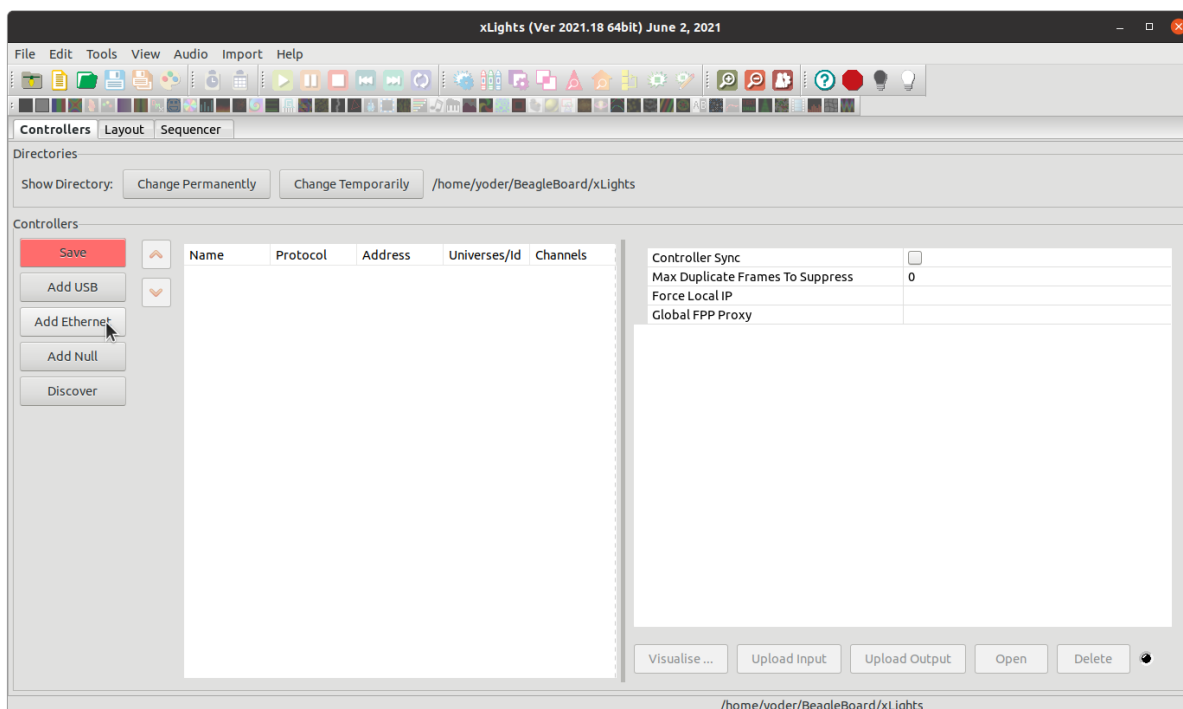

Fig. 1.18: xLights Setup

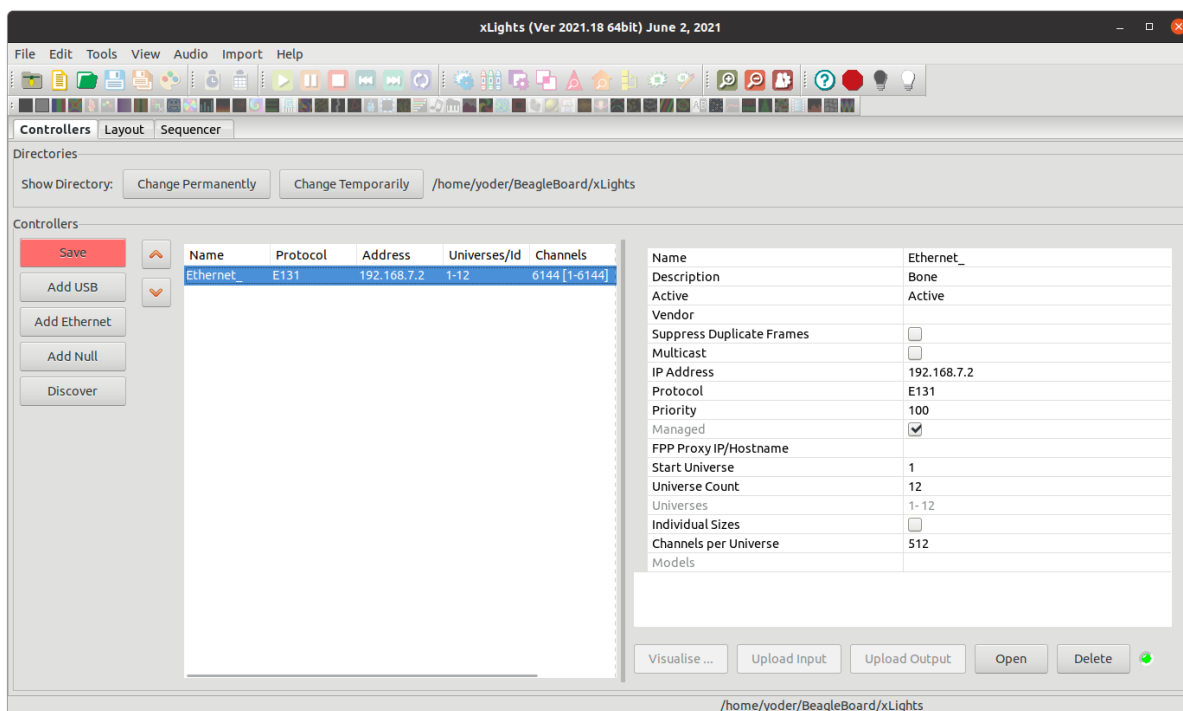

Fig. 1.19: Setting Up E1.31

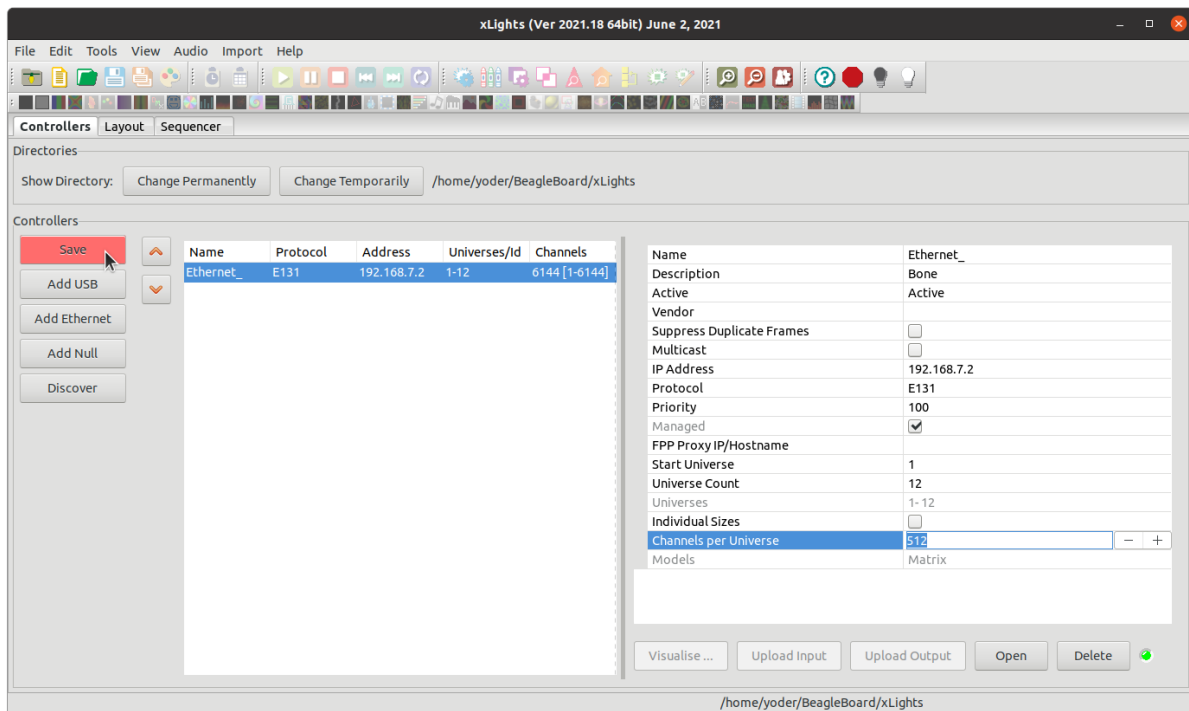

Fig. 1.20: xLights setup for P5 display

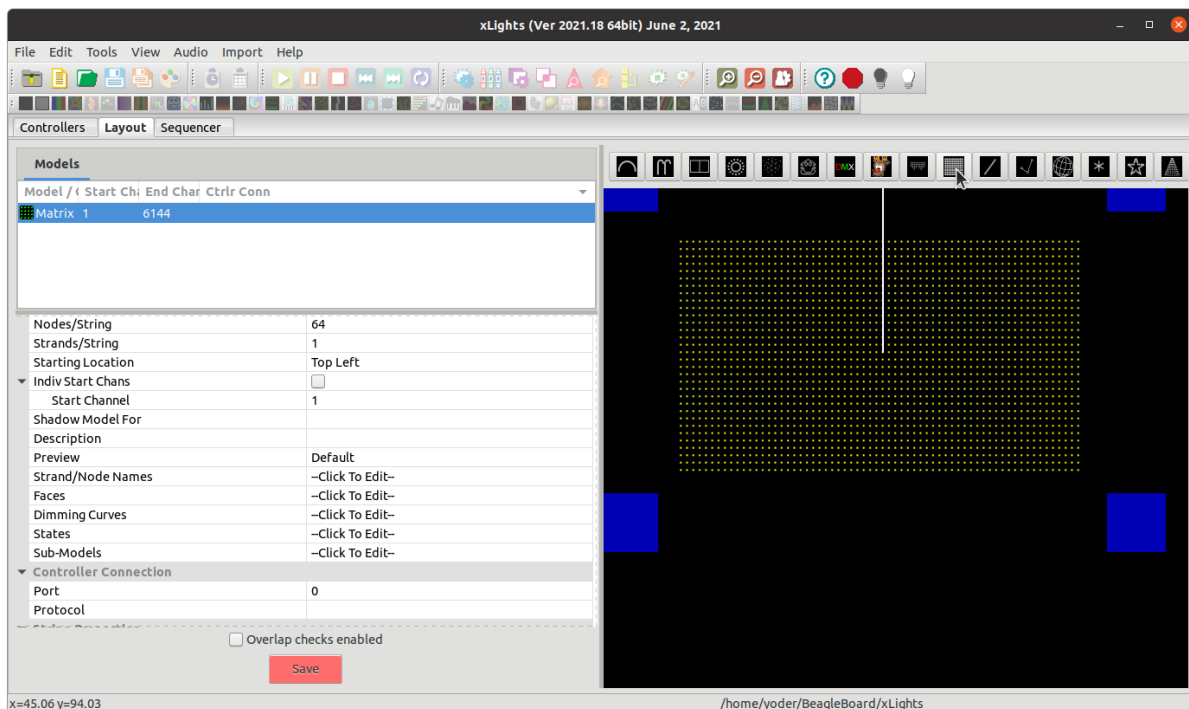

Fig. 1.21: Setting up the Matrix Layout

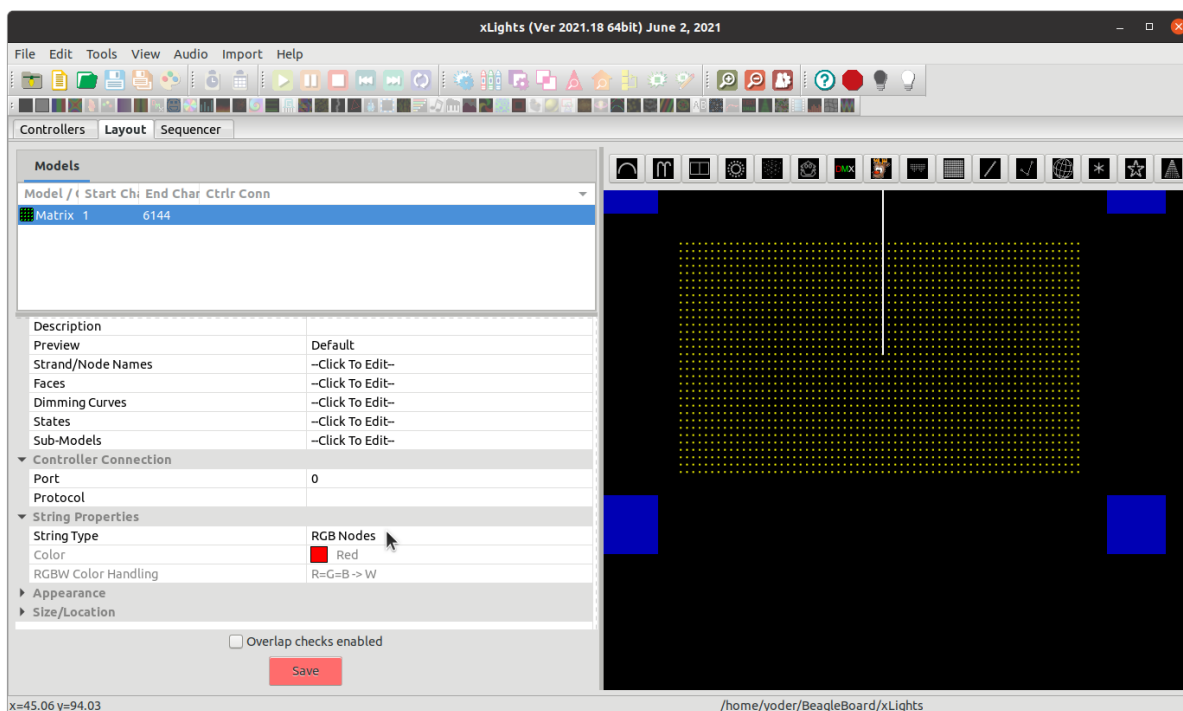

Fig. 1.22: Layout details for P5 matrix

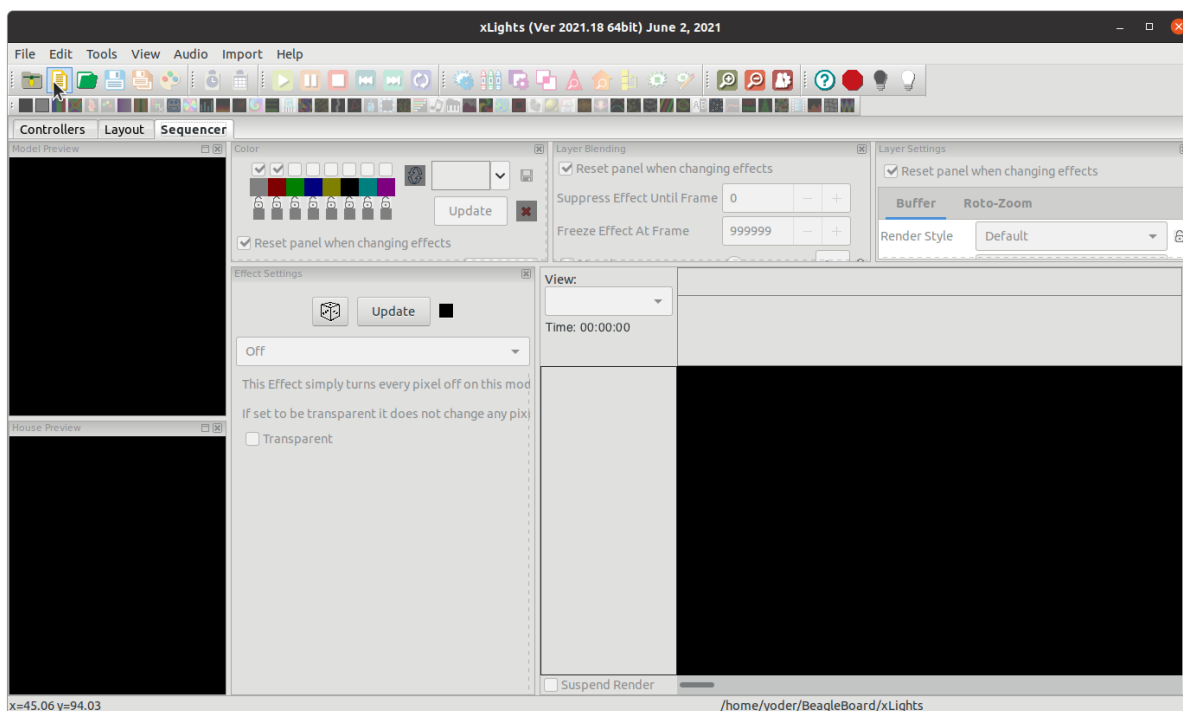

Fig. 1.23: Starting a new sequence

Setting Up E1.31 on the Bone

First we need to setup FPP to take input from xLights. Do this by going to the *Input/Output Setup* menu and selecting *Channel Inputs*. Then enter 12 for *Universe Count* and click set and you will see [E1.31 Inputs](#).

The screenshot shows the FPP v5.0 web interface for configuring Channel Inputs. The page title is "Channel Inputs" and the current menu is "Input/Output Setup". A red banner at the top indicates "E1.31/ArtNet/DDP Inputs". Below this, there are controls for "Enable Input" (checked), "Timeout" (0), and "Inputs Count" (12). A "Set" button is highlighted with a mouse cursor. Below these controls is a table of 12 inputs, each with a checked "Enable Input" box and a "Set" button. The table columns are: INPUT ACTIVE, DESCRIPTION, INPUT TYPE, FPP CHANNEL START, FPP CHANNEL END, UNIVERSE #, UNIVERSE COUNT, and UNIVERSE SIZE.

INPUT ACTIVE	DESCRIPTION	INPUT TYPE	FPP CHANNEL START	FPP CHANNEL END	UNIVERSE #	UNIVERSE COUNT	UNIVERSE SIZE
1		E1.31 - Multicas	1	512	1	1	512
2		E1.31 - Multicas	513	1024	2	1	512
3		E1.31 - Multicas	1025	1536	3	1	512
4		E1.31 - Multicas	1537	2048	4	1	512
5		E1.31 - Multicas	2049	2560	5	1	512
6		E1.31 - Multicas	2561	3072	6	1	512
7		E1.31 - Multicas	3073	3584	7	1	512
8		E1.31 - Multicas	3585	4096	8	1	512
9		E1.31 - Multicas	4097	4608	9	1	512
10		E1.31 - Multicas	4609	5120	10	1	512
11		E1.31 - Multicas	5121	5632	11	1	512
12		E1.31 - Multicas	5633	6144	12	1	512

(Drag entry to reposition)

Fig. 1.24: E1.31 Inputs

Click on the **Save** button above the table.

Then go to the **Status/Control** menu and select **Status Page**.

Todo: update this

Host: FPP, Idle, wlan0, Thu Feb 14 05:17:33 AM

Press F1 for help

Status

SCHEDULER STATUS: NEXT PLAYLIST: [Preview](#)

Please consider enabling the collection of anonymous statistics on the hardware and features used to help us improve FPP in the future. You may preview the data or disable this banner on the [Systems Settings Page](#).

[Enable Stats](#)

E1.31/DDP/ArtNet Packets and Bytes Received

[Update](#) Live Update Stats

Universe	Start Address	Packets	Bytes	Errors
1	1	0	0	0
2	49	0	0	0
3	97	0	0	0
4	145	0	0	0
5	193	0	0	0
6	241	0	0	0
7	289	0	0	0
8	337	0	0	0
9	385	0	0	0
10	433	0	0	0
11	481	0	0	0
12	529	0	0	0

[>_ Run FPP Command](#)
[FPP Mode: Bridge](#)
[↻ Reboot](#)
[🔌 Shutdown](#)
[🔄 Restart FPPD](#)
[■ Stop FPPD](#)

Fig. 1.25: Bridge Mode

Testing the xLights Connection

The Bone is now listening for commands from xLights via the E1.31 protocol. A quick way to verify everything is to return to xLights and go to the *Tools* menu and select **Test** ([xLights test page](#)).

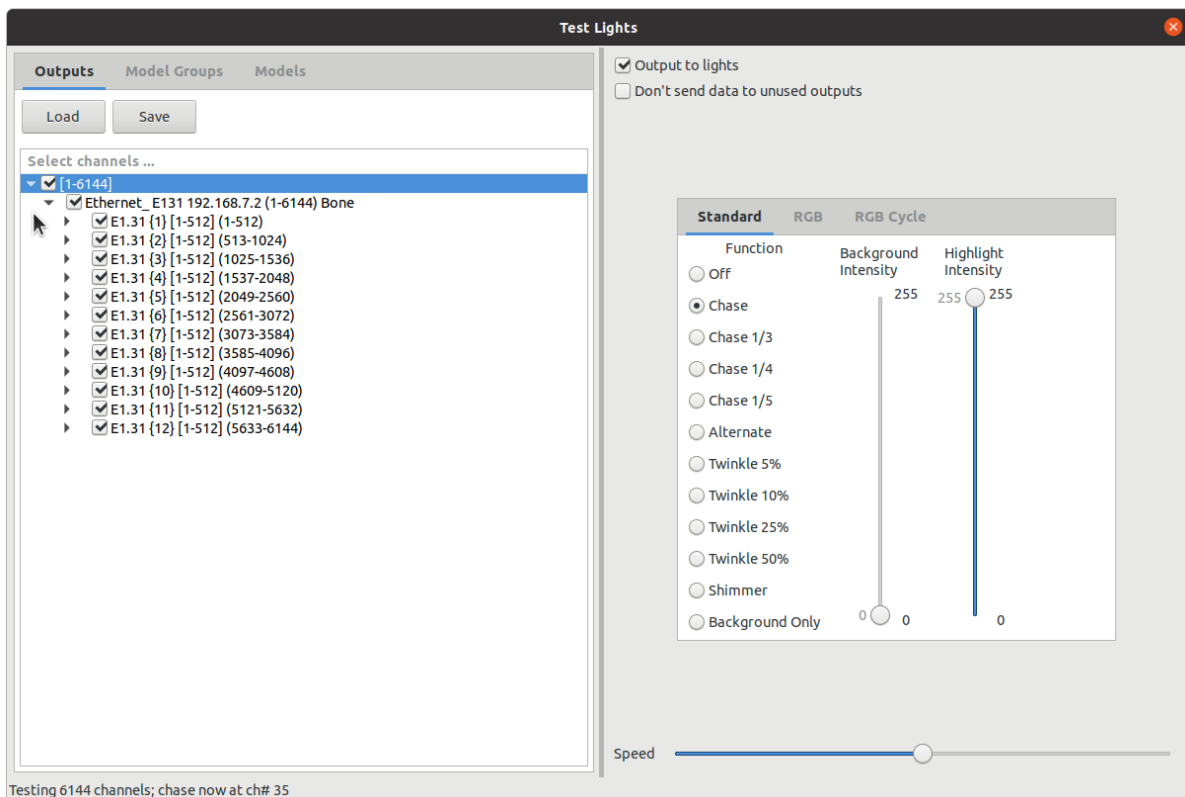

Fig. 1.26: xLights test page

Click the box under **Select channels...**, click **Output to lights** and select **Twinkle 50%**. You matrix should have a colorful twinkle pattern ([xLights Twinkle test pattern](#)).

A Simple xLights Sequence

Now that the xLights to FPP link is tested you can generate a sequence to play. Close the Test window and click on the **Sequencer** tab. Then drag an effect from the **Effects** box to the timeline that below it. Drop it to the right of the **Matrix** label ([Drag an effect to the timeline](#)). Then click **Output To Lights** which is the yellow lightbulb to the right on the top toolbar. Your matrix should now be displaying your effect.

The setup requires the host computer to send the animation data to the Bone. The next section shows how to save the sequence and play it on the Bone standalone.

Saving a Sequence and Playing it Standalone

In xLights save your sequence by hitting Ctrl-S and giving it a name. I called mine *fire* since I used a fire effect. Now, switch back to FPP and select the *Content Setup* menu and select *File Manager*. Click the black *Select Files* button and select your sequence file that ends in *.fseq* ([FPP file manager](#)).

Once your sequence is uploaded, got to **Content Setup** and select **Playlists**. Enter you playlist name (I used **fire**) and click **Add**. Then click **Add a Sequence/Entry** and select **Sequence Only** ([Adding a new playlist to FPP](#)), then click **Add**.

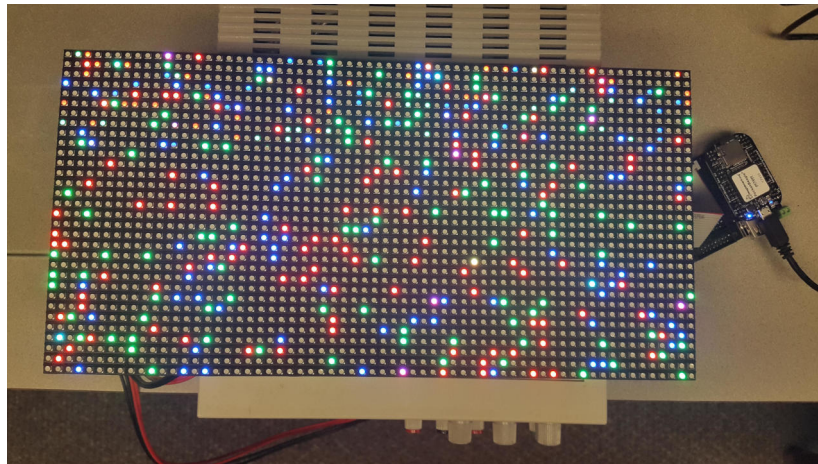

Fig. 1.27: xLights Twinkle test pattern

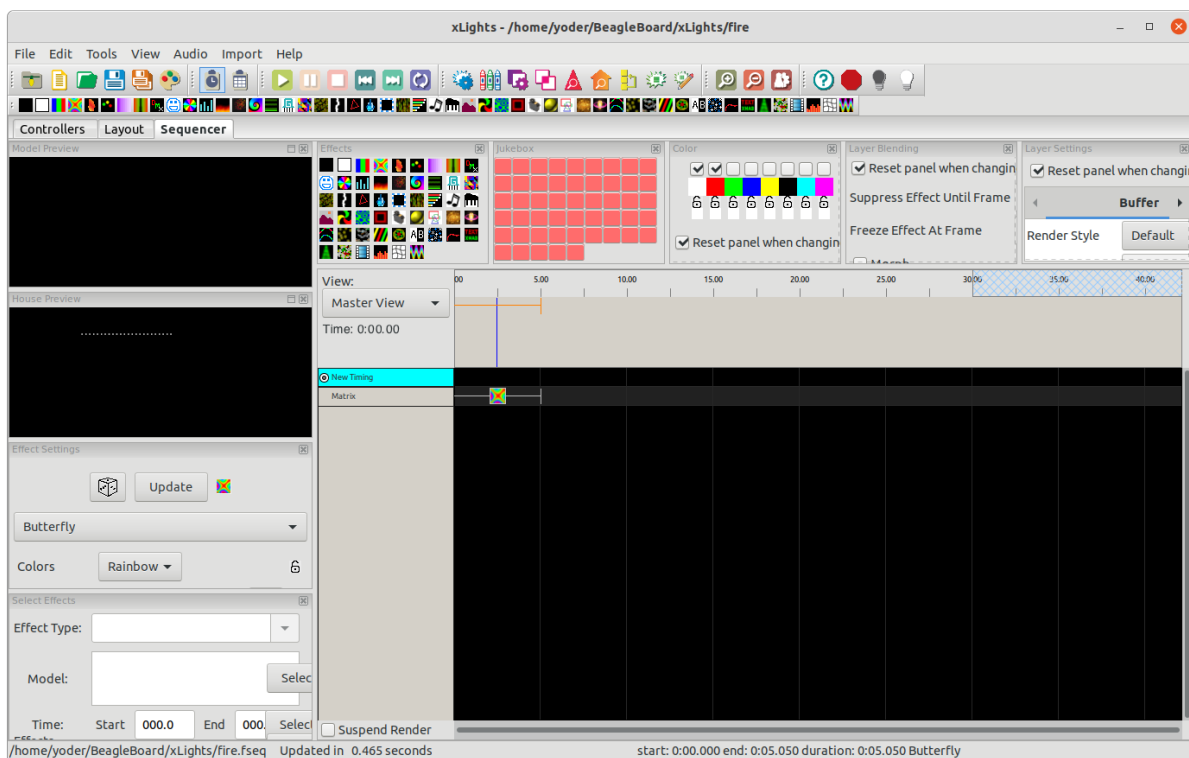

Fig. 1.28: Drag an effect to the timeline

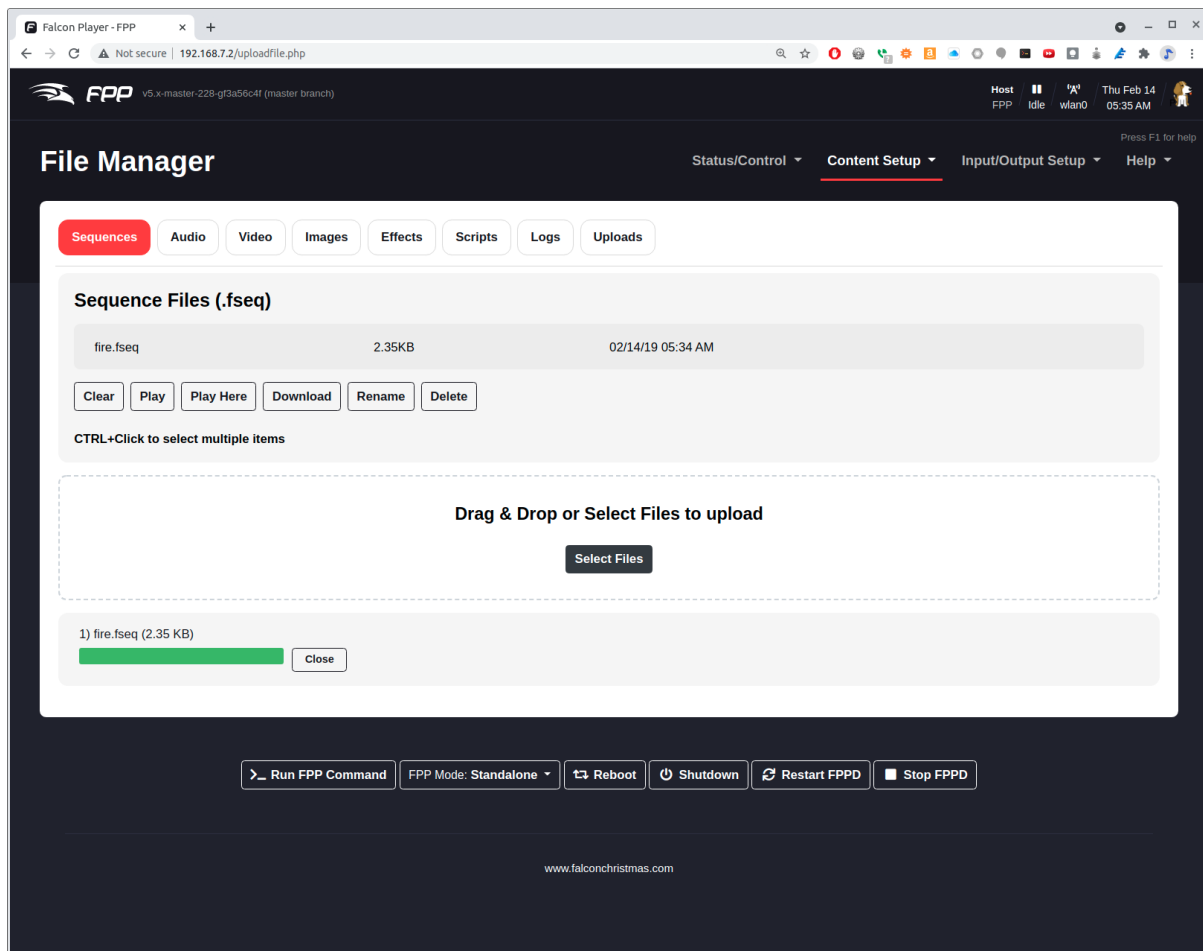

Fig. 1.29: FPP file manager

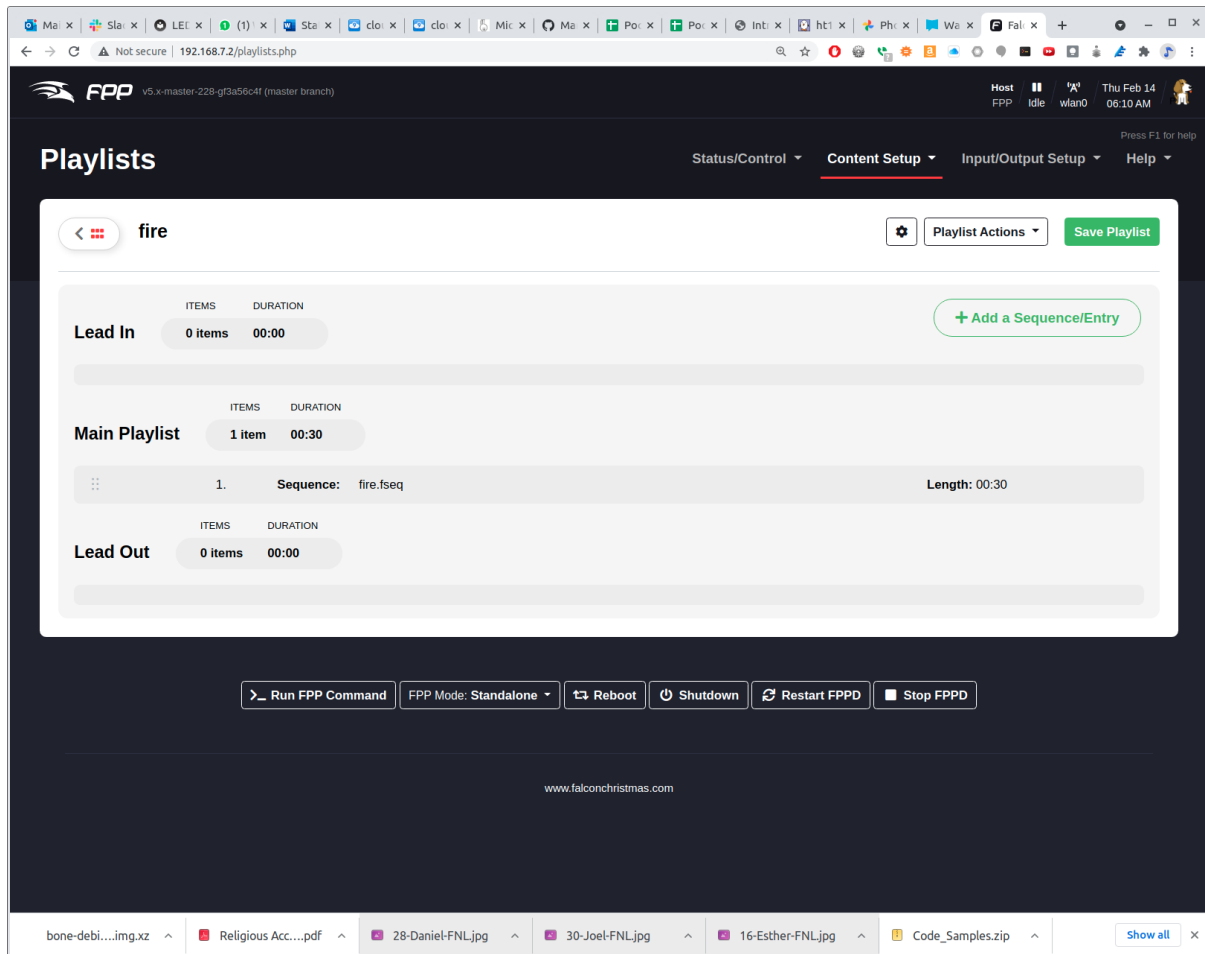

Fig. 1.30: Adding a new playlist to FPP

Be sure to click **Save Playlist** on the right. Now return to **Status/Control** and **Status Page** and make sure **FPPD Mode:** is set to **Standalone**. You should see your playlist. Click the **Play** button and your sequence will play.

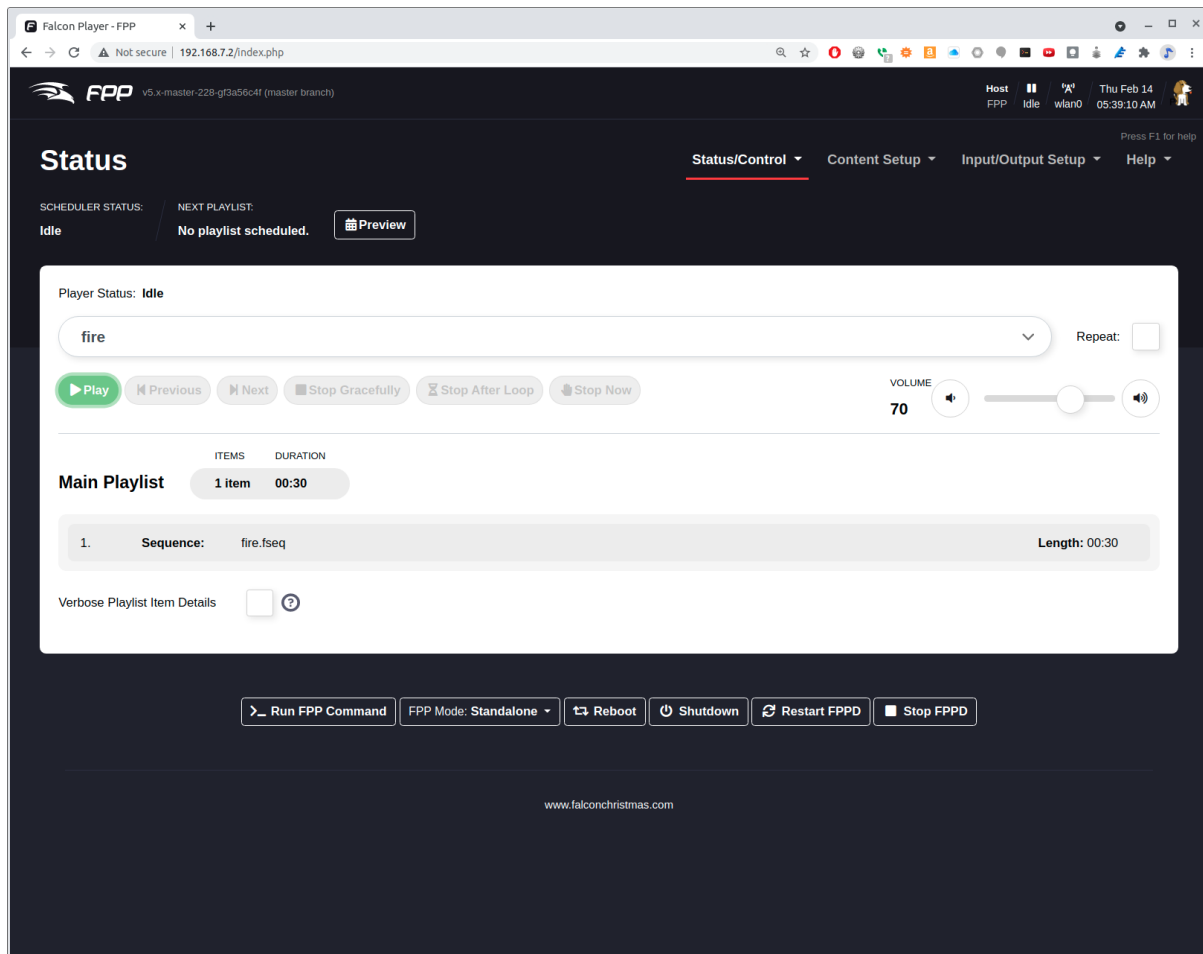

Fig. 1.31: Adding a new playlist to FPP

The beauty of the PRU is that the Beagle can play a detailed sequence at 20 frames per second and the ARM processor is only 15% used. The PRUs are doing all the work.

simpPRU - A python-like language for programming the PRUs

simpPRU is a simple, python-like programming language designed to make programming the PRUs easy. It has detailed [documentation](#) and many [examples](#).

information

simpPRU is a procedural programming language that is statically typed. Variables and functions must be assigned data types during compilation. It is type-safe, and data types of variables are decided during compilation. simpPRU codes have a `+.sim+` extension. simpPRU provides a console app to use Remoteproc functionality.

<https://simp pru.readthedocs.io/en/latest/>

You can [build simpPRU](#) from source, more easily just [install it](#). On the Beagle run:

```
bone$ wget https://github.com/VedantParanjape/simpPRU/releases/download/1.4/
↳simppru-1.4-armhf.deb
bone$ sudo dpkg -i simppru-1.4-armhf.deb
bone$ sudo apt update
bone$ sudo apt install gcc-pru
```

Now, suppose you wanted to run the **LED blink** example which is reproduced here.

Listing 1.3: LED Blink (blink.sim)

```
1 /* From: https://simppru.readthedocs.io/en/latest/examples/led_blink/ */
2 while : 1 == 1 {
3     digital_write(P1_31, true);
4     delay(250);      /* Delay 250 ms */
5     digital_write(P1_31, false);
6     delay(250);
7 }
```

blink.sim

Just run simppru

```
bone$ simppru blink.sim --load
Detected TI AM335x PocketBeagle
inside while
[4] : setting P1_31 as output

Current mode for P1_31 is:      pruout
```

Detected TI AM335x PocketBeagle

The `+load+` flag caused the compiled code to be copied to `+lib/firmware+`. To start just do:

```
bone$ cd /dev/remoteproc/pruss-core0/
bone$ ls
device firmware name power state subsystem uevent
bone$ echo start > state
bone$ cat state
running
```

Your LED should now be blinking.

Check out the many examples (https://simppru.readthedocs.io/en/latest/examples/led_blink/).

MachineKit

MachineKit is a platform for machine control applications. It can control machine tools, robots, or other automated devices. It can control servo motors, stepper motors, relays, and other devices related to machine tools.

information

Machinekit is portable across a wide range of hardware platforms and real-time environments, and delivers excellent performance at low cost. It is based on the HAL component architecture, an intuitive and easy to use circuit model that includes over 150 building blocks for digital logic, motion, control loops, signal processing, and hardware drivers. Machinekit supports local and networked UI options, including ubiquitous platforms like phones or tablets.

<http://www.machinekit.io/about/>

Examples

Digital Read
 Digital Write
 Delay
 LED Blink
 Hardware Counter
 LED Blink using while loop
 LED Blink using for loop
 LED Blink using hardware counter as delay
 HCSR04 Distance Sensor example
 LED Blink with button control
 Using RPMSG to communicate with ARM core
 Using RPMSG to implement a simple calculator on PRU
 Sending state of button using RPMSG
 HCSR04 Distance Sensor example (sending distance data to ARM using RPMSG)

LED blink example

**Table of contents**

Code
 Explanation

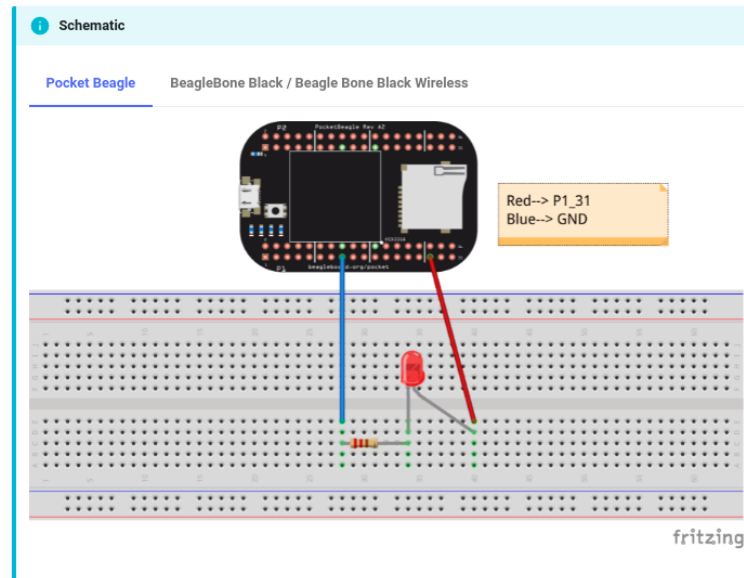

Fig. 1.32: simpPRU Examples

1.8.5 ArduPilot

ArduPilot is a open source autopilot system supporting multi-copters, traditional helicopters, fixed wing aircraft and rovers. ArduPilot runs on a many hardware platforms including the BeagleBone Black and the BeagleBone Blue.

information

Ardupilot is the most advanced, full-featured and reliable open source autopilot software available. It has been developed over 5+ years by a team of diverse professional engineers and computer scientists. It is the only autopilot software capable of controlling any vehicle system imaginable, from conventional airplanes, multirotors, and helicopters, to boats and even submarines. And now being expanded to feature support for new emerging vehicle types such as quad-planes and compound helicopters.

Installed in over 1,000,000 vehicles world-wide, and with its advanced data-logging, analysis and simulation tools, Ardupilot is the most tested and proven autopilot software. The open-source code base means that it is rapidly evolving, always at the cutting edge of technology development. With many peripheral suppliers creating interfaces, users benefit from a broad ecosystem of sensors, companion computers and communication systems. Finally, since the source code is open, it can be audited to ensure compliance with security and secrecy requirements.

The software suite is installed in aircraft from many OEM UAV companies, such as 3DR, jDrones, PrecisionHawk, AgEagle and Kespry. It is also used for testing and development by several large institutions and corporations such as NASA, Intel and Insitu/Boeing, as well as countless colleges and universities around the world.

Chapter 2

Getting Started

We assume you have some experience with the Beagle and are here to learn about the PRU. This chapter discusses what Beagles are out there, how to load the latest software image on your Beagle, how to run the Visual Studio Code IDE and how to blink an LED. ===== latest software image on your Beagle, how to run the Visual Studio Code (VS Code) IDE and how to blink an LED.

If you already have your Beagle and know your way around it, you can find the code at <https://git.beagleboard.org/beagleboard/pru-cookbook-code> and book contents at <https://git.beagleboard.org/docs/docs.beagleboard.io> under the books/pru-cookbook directory.

2.1 Selecting a Beagle

2.1.1 Problem

Which Beagle should you use?

2.1.2 Solution

<http://beagleboard.org/boards> lists the many Beagles from which to choose. Here we'll give examples for the venerable [BeagleBone Black](#), the robotics [BeagleBone Blue](#), tiny [PockeBeagle](#) and the powerful [AI](#). All the examples should also run on the other Beagles too.

2.1.3 Discussion

BeagleBone Black

If you aren't sure which Beagle to use, it's hard to go wrong with the [BeagleBone Black](#). It's the most popular member of the open hardware Beagle family.

The Black has:

- AM335x 1GHz ARM® Cortex-A8 processor
- 512MB DDR3 RAM
- 4GB 8-bit eMMC on-board flash storage
- 3D graphics accelerator
- NEON floating-point accelerator
- 2x PRU 32-bit microcontrollers
- USB client for power & communications



Fig. 2.1: BeagleBone Black

- USB host
- Ethernet
- HDMI
- 2x 46 pin headers

See <http://beagleboard.org/black> for more details.

BeagleBone Blue

The Blue is a good choice if you are doing robotics.



Fig. 2.2: BeagleBone Blue

The Blue has everything the Black has except it has no Ethernet and no HDMI. But it also has:

- Wireless: 802.11bgn, Bluetooth 4.1 and BLE
- Battery support: 2-cell LiPo with balancing, LED state-of-charge monitor
- Charger input: 9-18V
- Motor control: 8 6V @ 4A servo out, 4 bidirectional DC motor out, 4 quadrature encoder in
- Sensors: 9 axis IMU (accels, gyros, magnetometer), barometer, thermometer
- User interface: 11 user programmable LEDs, 2 user programmable buttons

In addition you can mount the Blue on the *EduMIP* kit as shown in [BeagleBone Blue EduMIP Kit](#) to get a balancing robot.

<https://www.hackster.io/53815/controlling-edumip-with-ni-labview-2005f8> shows how to assemble the robot and control it from LabVIEW.



Fig. 2.3: BeagleBone Blue EduMIP Kit

PocketBeagle

The **PocketBeagle** is the smallest member of the Beagle family. It is an ultra-tiny-yet-complete Beagle that is software compatible with the other Beagles.

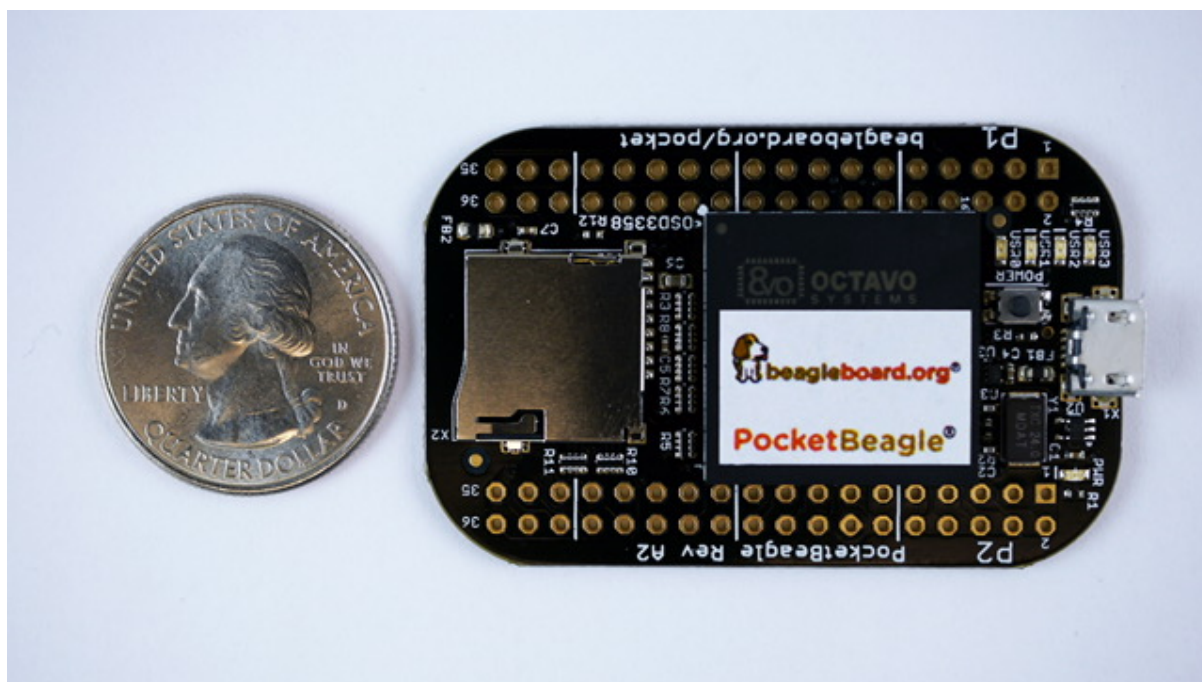

Fig. 2.4: PocketBeagle

The Pocket is based on the same processor as the Black and Blue and has:

- 8 analog inputs
- 44 digital I/Os and
- numerous digital interface peripherals

See <http://beagleboard.org/pocket> for more details.

BeagleBone AI

If you want to do deep learning, try the **BeagleBone AI**.

The AI has:

- Dual Arm® Cortex®-A15 microprocessor subsystem
- 2 C66x floating-point VLIW DSPs
- 2.5MB of on-chip L3 RAM
- 2x dual Arm® Cortex®-M4 co-processors
- 4x Embedded Vision Engines (EVEs)
- 2x dual-core Programmable Real-Time Unit and Industrial Communication SubSystem (PRU-ICSS)
- 2D-graphics accelerator (BB2D) subsystem
- Dual-core PowerVR® SGX544™ 3D GPU
- IVA-HD subsystem (4K @ 15fps encode and decode support for H.264, 1080p60 for others)
- BeagleBone Black mechanical and header compatibility

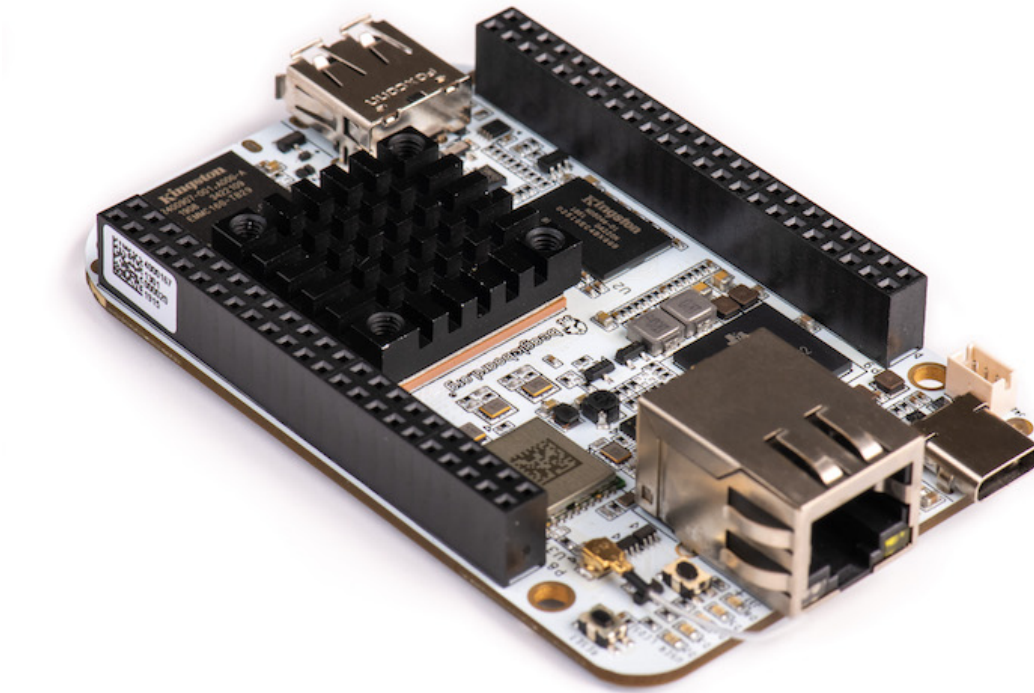

Fig. 2.5: BeagleBone AI

- 1GB RAM and 16GB on-board eMMC flash with high-speed interface
- USB type-C for power and superspeed dual-role controller; and USB type-A host
- Gigabit Ethernet, 2.4/5GHz WiFi, and Bluetooth
- microHDMI
- Zero-download out-of-box software experience with Debian GNU/Linux

2.2 Installing the Latest OS on Your Bone

2.2.1 Problem

You want to find the latest version of Debian that is available for your Bone.

2.2.2 Solution

On your host computer open a browser and go to <http://www.beagleboard.org/distros>.

Todo: Update links

This shows you two current choices of recent Debian images, one for the BeagleBone AI (AM5729 Debian 10.3 2020-04-06 8GB SD IoT TIDL) and one for all the other Beagles (AM3358 Debian 10.3 2020-04-06 4GB SD IoT). Download the one for your Beagle.

It contains all the packages we'll need.

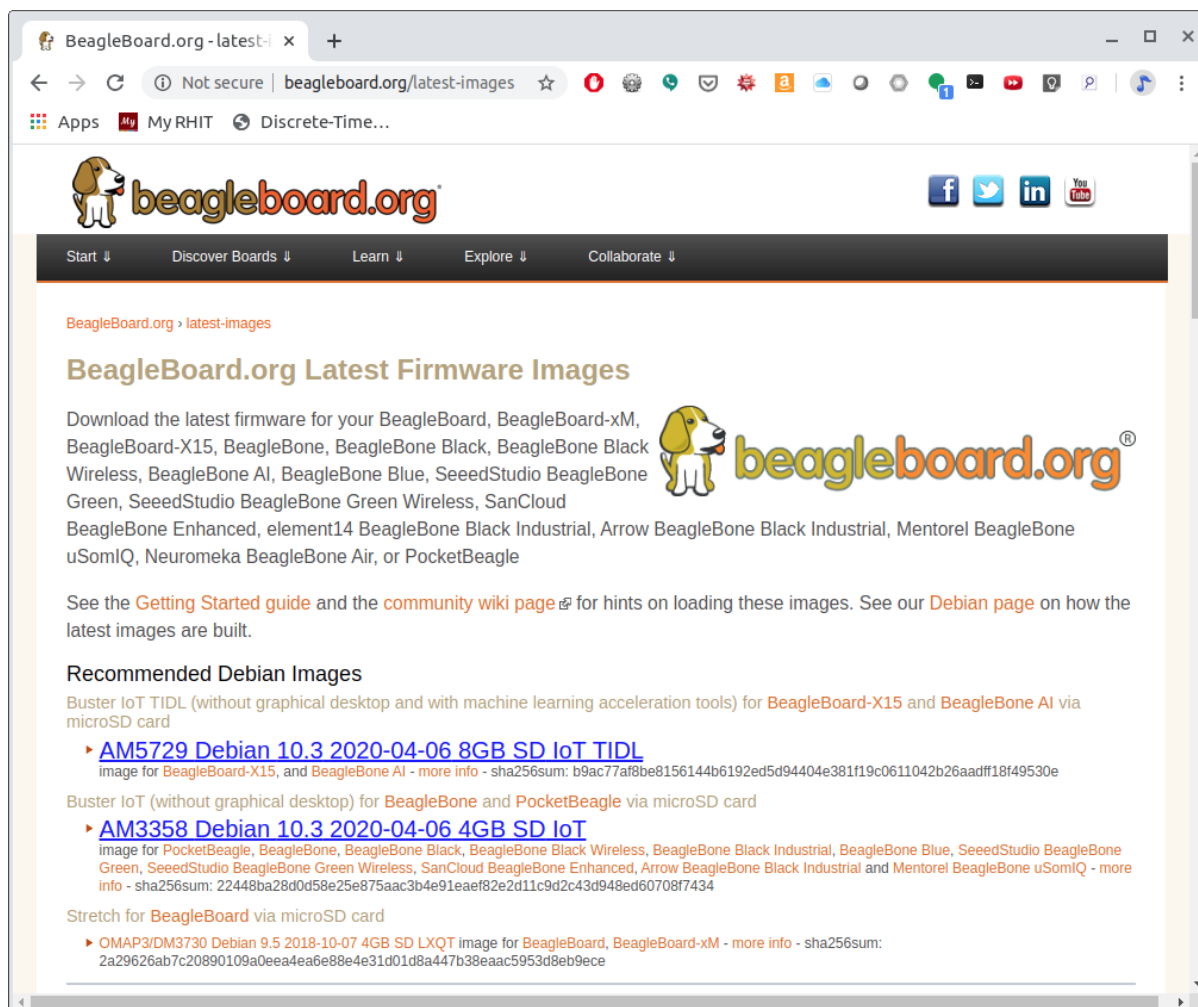

Fig. 2.6: Latest Debian images

2.3 Flashing a Micro SD Card

2.3.1 Problem

I've downloaded the image and need to flash my micro SD card.

2.3.2 Solution

Get a micro SD card that has at least 4GB and preferably 8GB.

There are many ways to flash the card, but the best seems to be Etcher by <https://www.balena.io/>. Go to <https://www.balena.io/etcher/> and download the version for your host computer. Fire up Etcher, select the image you just downloaded (no need to uncompress it, Etcher does it for you), select the SD card and hit the *Flash* button and wait for it to finish.



Fig. 2.7: Etcher

Once the SD is flashed, insert it in the Beagle and power it up.

2.4 Visual Studio Code IDE

2.4.1 Problem

How do I manage and edit my files?

2.4.2 Solution

The image you downloaded includes *Visual Studio Code*, a web-based integrated development environment (IDE) as shown in *Visual Studio Code IDE*.

Just point the browser on your host computer to <http://192.168.7.2:3000> and start exploring. You may also want to upgrade *bb-code-server* to pull in the latest updates. Another route to take is to apply this command to boot the service called *bb-code-server*.

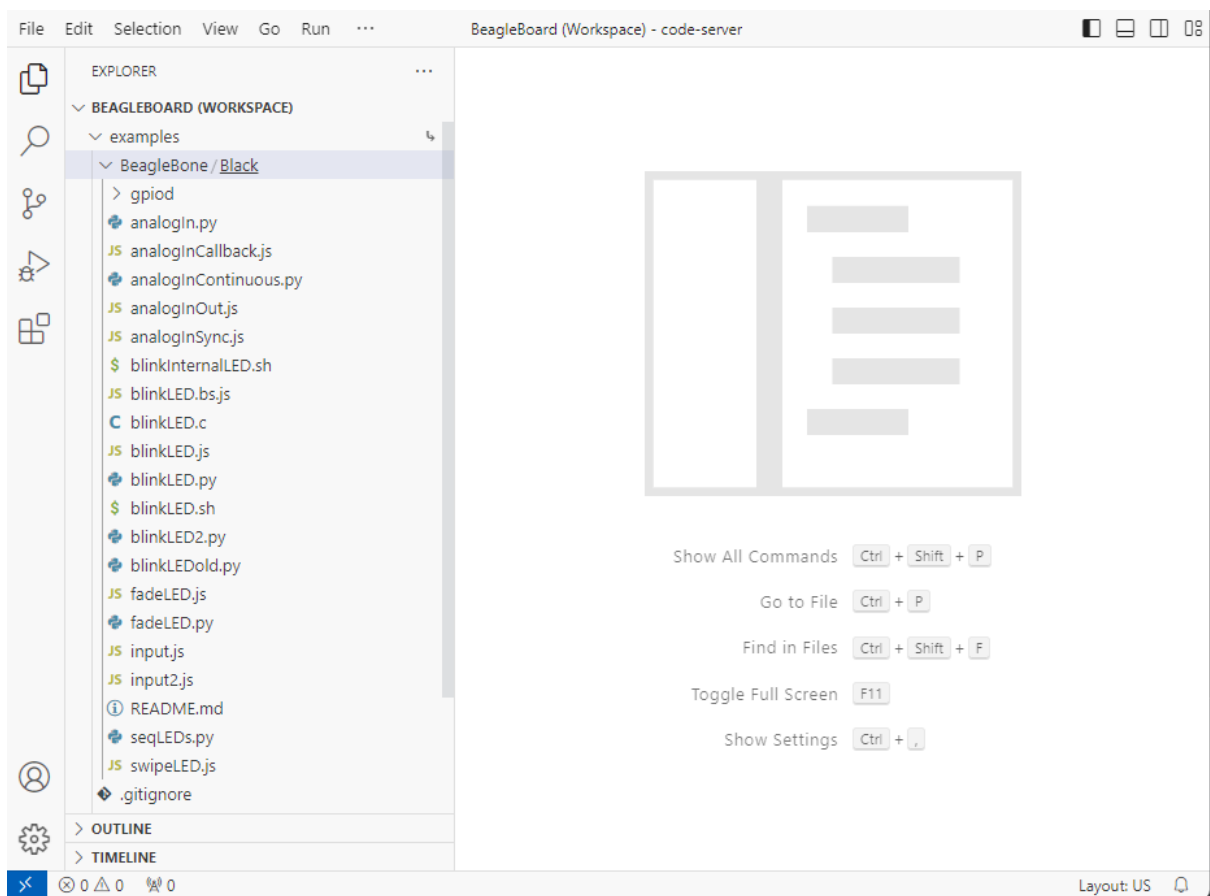

Fig. 2.8: Visual Studio Code IDE

```
sudo systemctl start bb-code-server.service
```

If you want the files in your home directory to appear in the tree structure click the settings gear and select *Show Home in Favorites* as shown in [Visual Studio Code Showing Home files](#).

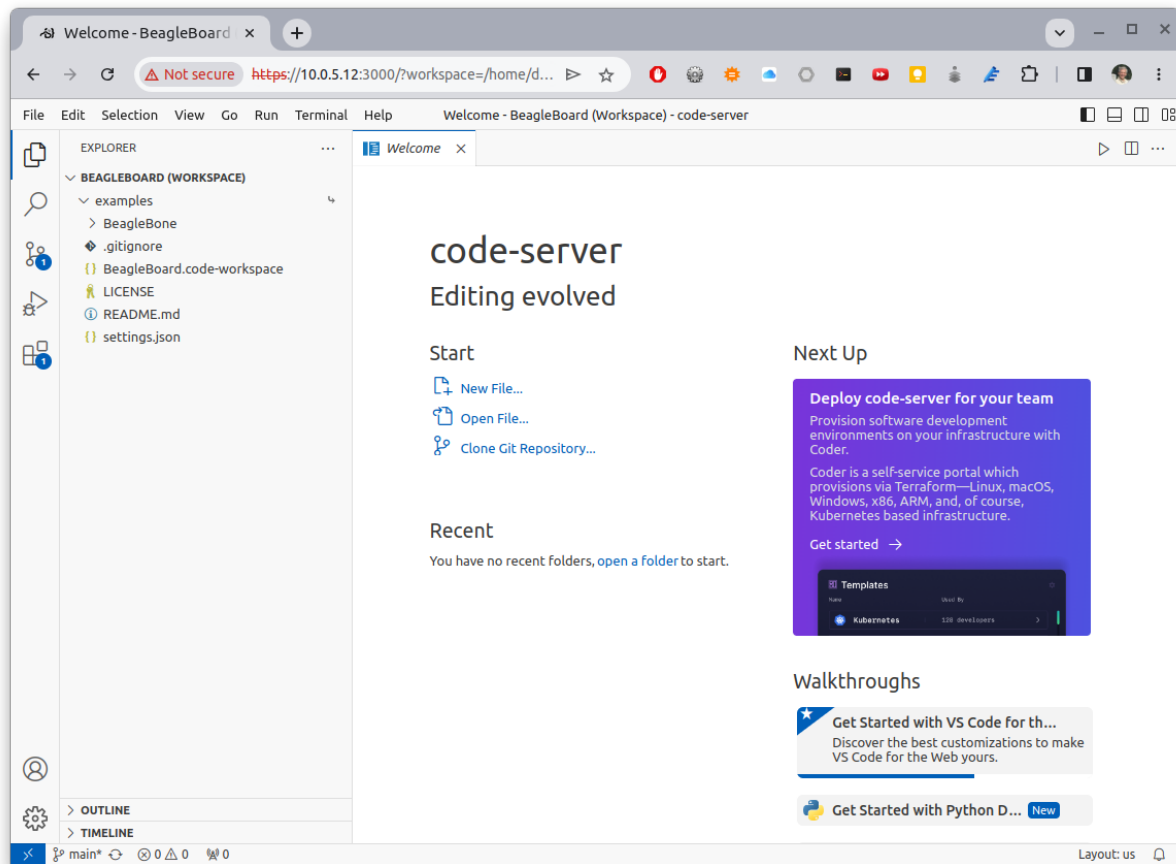

Fig. 2.9: Visual Studio Code Showing Home files

Just point the browser on your host computer to <http://192.168.7.2:3000> and start exploring.

If you want to edit files beyond your home directory you can link to the root file system by:

```
bone:~$ cd
bone:~$ ln -s / root
bone:~$ cd root
bone:~$ ls
bbb-uEnv.txt  boot  etc  ID.txt  lost+found  mnt  opt  root  sbin
→ sys  usr
bin  dev  home  lib  media  nfs-uEnv.txt  proc  run  srv
→ tmp  var
```

Now you can reach all the files from VS Code.

2.5 Getting Example Code

2.5.1 Problem

You are ready to start playing with the examples and need to find the code.

2.5.2 Solution

You can find the code on the PRU Cookbook Code project on [git.beagleboard.org](https://git.beagleboard.org/beagleboard/pru-cookbook-code): <https://git.beagleboard.org/beagleboard/pru-cookbook-code>. Just clone it on your Beagle.

```
bone:~$ cd /opt/source
bone:~$ git clone https://git.beagleboard.org/beagleboard/pru-cookbook-code
bone:~$ cd pru-cookbook-code
bone:~$ sudo ./install.sh
bone:~$ ls -F
01case/  03details/  05blocks/  07more/  README.md
02start/ 04details/  06io/      08ai/
```

Each chapter has its own directory that has all of the code.

```
bone:~$ cd 02start/
bone:~$ ls
hello.pru0.c  hello.pru1_1.c  Makefile  setup.sh
ai.notes      hello2.pru1_1.c  hello2.pru2_1.c  Makefile
hello2.pru0.c  hello2.pru1.c   hello.pru0.c     setup2.sh*
hello2.pru1_0.c  hello2.pru2_0.c  hello.pru1_1.c   setup.sh*
```

Go and explore.

2.6 Blinking an LED

2.6.1 Problem

You want to make sure everything is set up by blinking an LED.

2.6.2 Solution

The ‘hello, world’ of the embedded world is to flash an LED. [hello.pru0.c](#) is some code that blinks the USR3 LED ten times using the PRU.

Todo: The ‘s and _’s in the code are messing with the formatting.

Listing 2.1: hello.pru0.c

```
1 #include <stdint.h>
2 #include <pru_cfg.h>
3 #include "resource_table_empty.h"
4 #include "prugpio.h"
5
6 volatile register unsigned int __R30;
7 volatile register unsigned int __R31;
8
9 void main(void) {
10     int i;
11
12     uint32_t *gpio1 = (uint32_t *)GPIO1;
13
14     /* Clear SYSCFG[STANDBY_INIT] to enable OCP master port */
15     CT_CFG.SYSCFG_bit.STANDBY_INIT = 0;
16
17     for(i=0; i<10; i++) {
18         gpio1[GPIO_SETDATAOUT] = USR3;           // The the USR3 LED_
```

(continues on next page)

(continued from previous page)

```

19  ↪on
20      __delay_cycles(500000000/5);           // Wait 1/2 second
21
22      gpio1[GPIO_CLEARDATAOUT] = USR3;
23
24      __delay_cycles(500000000/5);
25
26      }
27      __halt();
28  }
29
30  // Turns off triggers
31  #pragma DATA_SECTION(init_pins, ".init_pins")
32  #pragma RETAIN(init_pins)
33  const char init_pins[] =
34      "/sys/class/leds/beaglebone:green:usr3/trigger\nnone\n0" \
35      "\0\0";

```

hello.pru0.c

Later chapters will go into details of how this code works, but if you want to run it right now do the following.

```

bone:~$ cd /opt/source
bone:~$ git clone https://git.beagleboard.org/beagleboard/pru-cookbook-code
bone:~$ cd pru-cookbook-code/02start
bone:~$ sudo ../install.sh

```

Tip: If the following doesn't work see [Compiling with clpru and lnkpru](#) for installation instructions.

Running Code on the Black or Pocket

```

bone:~$ make TARGET=hello.pru0
/opt/source/pru-cookbook-code/common/Makefile:27: MODEL=TI_AM335x_BeagleBone_
↪Green_Wireless,TARGET=hello.pru0,COMMON=/opt/source/pru-cookbook-code/
↪common
- Stopping PRU 0
CC hello.pru0.c
"/opt/source/pru-cookbook-code/common/prugpio.h", line 53: warning #1181-D:
↪#warning directive: "Found else"
LD /tmp/vsx-examples/hello.pru0.o
- copying firmware file /tmp/vsx-examples/hello.pru0.out to /lib/firmware/
↪am335x-pru0-fw
- Starting PRU 0
write_init_pins.sh
writing "none" to "/sys/class/leds/beaglebone:green:usr3/trigger"
MODEL    = TI_AM335x_BeagleBone_Green_Wireless
PROC     = pru
PRUN    = 0
PRU_DIR  = /sys/class/remoteproc/remoteproc1

```

Tip: If you get the following error:

```

cp: cannot create regular file '/lib/firmware/am335x-pru0-fw': Permission_
↪denied

```

Run the following command to set the permissions.

```
bone:~$ sudo chown debian:debian /lib/firmware/am335x-pru*
```

Running Code on the AI

```
bone$ make TARGET=hello.pru1_1
/var/lib/code-server/common/Makefile:28: MODEL=BeagleBoard.org_BeagleBone_AI,
↳TARGET=hello.pru1_1
- Stopping PRU 1_1
CC hello.pru1_1.c
"/var/lib/code-server/common/prugpio.h", line 4: warning #1181-D: #warning_
↳directive: "Found AI"
LD /tmp/code-server-examples/hello.pru1_1.o
- copying firmware file /tmp/code-server-examples/hello.pru1_1.out to /lib/
↳firmware/am57xx-pru1_1-fw
write_init_pins.sh
writing "none" to "/sys/class/leds/beaglebone:green:usr3/trigger"
- Starting PRU 1_1
MODEL = BeagleBoard.org_BeagleBone_AI
PROC = pru
PRUN = 1_1
PRU_DIR = /dev/remoteproc/pruss1-core1
rm /tmp/code-server-examples/hello.pru1_1.o
```

Look quickly and you will see the **USR3 LED** blinking.

Later sections give more details on how all this works.

Chapter 3

Running a Program; Configuring Pins

There are a lot of details in compiling and running PRU code. Fortunately those details are captured in a common *Makefile* that is used throughout this book. This chapter shows how to use the *Makefile* to compile code and also start and stop the PRUs.

Note: The following are resources used in this chapter:

- PRU Code Generation Tools - Compiler
 - PRU Software Support Package
 - PRU Optimizing C/C++ Compiler
 - PRU Assembly Language Tools
 - AM572x Technical Reference Manual (AI)
 - AM335x Technical Reference Manual (All others)
-

3.1 Getting Example Code

3.1.1 Problem

I want to get the files used in this book.

3.1.2 Solution

It's all on a GitHub repository.

```
bone$ cd /opt/source
bone$ git clone https://git.beagleboard.org/beagleboard/pru-cookbook-code
bone$ cd pru-cookbook-code
bone$ sudo ./install.sh
```

Todo: The version of code used needs to be noted in the documentation.

Todo: Why is this documented in multiple places?

3.2 Compiling with clpru and lnkpru

3.2.1 Problem

You need details on the c compiler, linker and other tools for the PRU.

3.2.2 Solution

The PRU compiler and linker are already installed on many images. They are called `clpru` and `lnkpru`. Do the following to see if `clpru` is installed.

```
bone$ which clpru
/usr/bin/clpru
```

Tip: If `clpru` isn't installed, follow the instructions at https://elinux.org/Beagleboard:BeagleBoneBlack_Debian#TI_PRU_Code_Generation_Tools to install it.

```
bone$ sudo apt update
bone$ sudo apt install ti-pru-cgt-installer
```

Details on each can be found here:

- [PRU Optimizing C/C++ Compiler](#)
- [PRU Assembly Language Tools](#)

In fact there are PRU versions of many of the standard code generation tools.

code tools

```
bone$ ls /usr/bin/*pru
/usr/bin/abspru      /usr/bin/clistpru  /usr/bin/hexpru    /usr/bin/ofdpru
/usr/bin/acpiapru   /usr/bin/clpru    /usr/bin/ilkpru    /usr/bin/optpru
/usr/bin/arpru      /usr/bin/dempru   /usr/bin/libinfopru /usr/bin/rc_test_
→encoders_pru
/usr/bin/asmpru     /usr/bin/dispru   /usr/bin/lnkpru    /usr/bin/strippru
/usr/bin/cgpru      /usr/bin/embedpru /usr/bin/nmpru     /usr/bin/xrefpru
```

See the [PRU Assembly Language Tools](#) for more details.

3.3 Making sure the PRUs are configured

3.3.1 Problem

When running the Makefile for the PRU you get an error about `/dev/remoteproc` is missing.

3.3.2 Solution

Edit `/boot/uEnv.txt` and enable `pru_rproc` by doing the following.

```
bone$ sudo vi /boot/uEnv.txt
```

Around line 40 you will see:

```
###pru_rproc (4.19.x-ti kernel)
uboot_overlay_pru=AM335X-PRU-RPROC-4-19-TI-00A0.dtbo
```

Uncomment the `uboot_overlay` line as shown and then reboot. `/dev/remoteproc` should now be there.

```
bone$ sudo reboot
bone$ ls -ls /dev/remoteproc/
total 0
0 lrwxrwxrwx 1 root root 33 Jul 29 16:12 pruss-core0 -> /sys/class/
↳remoteproc/remoteproc1
0 lrwxrwxrwx 1 root root 33 Jul 29 16:12 pruss-core1 -> /sys/class/
↳remoteproc/remoteproc2
```

3.4 Compiling and Running

3.4.1 Problem

I want to compile and run an example.

3.4.2 Solution

Change to the directory of the code you want to run.

```
bone$ cd pru-cookbook-code/06io
bone$ ls
gpio.pru0.c  Makefile  setup.sh
```

Source the setup file.

```
bone$ source setup.sh
TARGET=gpio.pru0
PocketBeagle Found
P2_05
Current mode for P2_05 is:      gpio
Current mode for P2_05 is:      gpio
```

Now you are ready to compile and run. This is automated for you in the Makefile

```
bone$ make
/opt/source/pru-cookbook-code/common/Makefile:27: MODEL=TI_AM335x_BeagleBone_
↳Green_Wireless, TARGET=gpio.pru0, COMMON=/opt/source/pru-cookbook-code/common
- Stopping PRU 0
- CC gpio.pru0.c
"/opt/source/pru-cookbook-code/common/prugpio.h", line 53: warning #1181-D:
↳#warning directive: "Found else"
LD /tmp/vsx-examples/gpio.pru0.o
- copying firmware file /tmp/vsx-examples/gpio.pru0.out to /lib/firmware/
↳am335x-pru0-fw
- Starting PRU 0
write_init_pins.sh
MODEL = TI_AM335x_BeagleBone_Green_Wireless
PROC = pru
PRUN = 0
PRU_DIR = /sys/class/remoteproc/remoteproc1
rm /tmp/vsx-examples/gpio.pru0.o
```

Congratulations, you are now running a PRU. If you have an LED attached to P9_11 on the Black, or P2_05 on the Pocket, it should be blinking.

3.4.3 Discussion

The `setup.sh` file sets the `TARGET` to the file you want to compile. Set it to the filename, without the `.c` extension (`gpio.pru0`). The file extension `.pru0` specifies the number of the PRU you are using (either `1_0`, `1_1`, `2_0`, `2_1` on the AI or `0` or `1` on the others)

You can override the `TARGET` on the command line.

```
bone$ cp gpio.pru0.c gpio.pru1.c
bone$ export TARGET=gpio.pru1
```

Notice the `TARGET` doesn't have the `.c` on the end.

You can also specify them when running `make`.

```
bone$ cp gpio.pru0.c gpio.pru1.c
bone$ make TARGET=gpio.pru1
```

The `setup` file also contains instructions to figure out which Beagle you are running and then configure the pins accordingly.

Listing 3.1: `setup.sh`

```
1  #!/bin/bash
2
3  export TARGET=gpio.pru0
4  echo TARGET=$TARGET
5
6  # Configure the PRU pins based on which Beagle is running
7  machine=$(awk '{print $NF}' /proc/device-tree/model)
8  echo -n $machine
9  if [ $machine = "Black" ]; then
10     echo " Found"
11     pins="P9_11"
12 elif [ $machine = "Blue" ]; then
13     echo " Found"
14     pins=""
15 elif [ $machine = "PocketBeagle" ]; then
16     echo " Found"
17     pins="P2_05"
18 else
19     echo " Not Found"
20     pins=""
21 fi
22
23 for pin in $pins
24 do
25     echo $pin
26     config-pin $pin gpio
27     config-pin -q $pin
28 done
```

`setup.sh`

Line	Explanation
2-5	Set which PRU to use and which file to compile.
7	Figure out which type of Beagle we have.
9-21	Based on the type, set the <code>pins</code> .
23-28	Configure (set the pin mux) for each of the pins.

Tip: The BeagleBone AI has its pins preconfigured at boot time, so there's no need to use `config-pin`.

The `Makefile` stops the PRU, compiles the file and moves it where it will be loaded, and then restarts the PRU.

3.5 Stopping and Starting the PRU

3.5.1 Problem

I want to stop and start the PRU.

3.5.2 Solution

It's easy, if you already have `TARGET` set up:

```
bone$ make stop
- Stopping PRU 0
stop
bone$ make start
- Starting PRU 0
start
```

See [dmesg Hw](#) to see how to tell if the PRU is stopped.

This assumes `TARGET` is set to the PRU you are using. If you want to control the other PRU use:

```
bone$ cp gpio.pru0.c gpio.pru1.c
bone$ make TARGET=gpio.pru1
bone$ make TARGET=gpio.pru1 stop
bone$ make TARGET=gpio.pru1 start
```

3.6 The Standard Makefile

3.6.1 Problem

There are all sorts of options that need to be set when compiling a program. How can I be sure to get them all right?

3.6.2 Solution

The surest way to make sure everything is right is to use our standard `Makefile`.

3.6.3 Discussion

It's assumed you already know how `Makefiles` work. If not, there are many resources online that can bring you up to speed. Here is the local `Makefile` used throughout this book.

Listing 3.2: Local Makefile

```
1 include /opt/source/pru-cookbook-code/common/Makefile
```

`Makefile`

Each of the local `Makefiles` refer to the same standard `Makefile`. The details of how the `Makefile` works is beyond the scope of this cookbook.

Fortunately you shouldn't have to modify the `Makefile`.

3.7 The Linker Command File - am335x_pru.cmd

3.7.1 Problem

The linker needs to be told where in memory to place the code and variables.

3.7.2 Solution

am335x_pru.cmd is the standard linker command file that tells the linker where to put what for the BeagleBone Black and Blue, and the Pocket. The am57xx_pru.cmd does the same for the AI. «««< HEAD Both files can be found in /var/lib/code-server/common. ===== Both files can be found in /opt/source/pru-cookbook-code/common. »»»> bf423e10a7d607eb485449d3f53e7823264dfebb

Listing 3.3: am335x_pru.cmd

```

1  /
   ↳*****
   ↳
2  /*  AM335x_PRU.cmd
   ↳*/
3  /*  Copyright (c) 2015  Texas Instruments Incorporated
   ↳*/
4  /*
   ↳*/
5  /*  Description: This file is a linker command file that can be used for
   ↳*/
6  /*
   ↳*/
7  /*
   ↳*/
8  /
   ↳*****
   ↳
9
10 -cr
   ↳using C conventions */
11
12 /* Specify the System Memory Map */
13 MEMORY
14 {
15     PAGE 0:
16         PRU_IMEM                : org = 0x00000000 len = 0x00002000 /* 8kB
   ↳PRU0 Instruction RAM */
17
18     PAGE 1:
19
20         /* RAM */
21
22         PRU_DMEM_0_1            : org = 0x00000000 len = 0x00002000 CREGISTER=24 /
   ↳* 8kB PRU Data RAM 0_1 */
23         PRU_DMEM_1_0            : org = 0x00002000 len =
   ↳0x00002000 CREGISTER=25 /* 8kB PRU Data RAM 1_0 */
24
25     PAGE 2:
26         PRU_SHAREDMEM           : org = 0x00010000 len = 0x00003000 CREGISTER=28
   ↳/* 12kB Shared RAM */
27
28         DDR                      : org = 0x80000000 len =
   ↳0x00000100 CREGISTER=31
29         L3OCMC                   : org = 0x40000000 len =

```

(continues on next page)

(continued from previous page)

```

30 ↪0x00010000      CREGISTER=30
31
32      /* Peripherals */
33
34      PRU_CFG      : org = 0x00026000 len =_
35 ↪0x00000044      CREGISTER=4
36      PRU_ECAP     : org = 0x00030000 len =_
37 ↪0x00000060      CREGISTER=3
38      PRU_IEP      : org = 0x0002E000 len =_
39 ↪0x0000031C      CREGISTER=26
40      PRU_INTC     : org = 0x00020000 len =_
41 ↪0x00001504      CREGISTER=0
42      PRU_UART     : org = 0x00028000 len =_
43 ↪0x00000038      CREGISTER=7
44
45      DCAN0        : org = 0x481CC000 len =_
46 ↪0x000001E8      CREGISTER=14
47      DCAN1        : org = 0x481D0000 len =_
48 ↪0x000001E8      CREGISTER=15
49      DMTIMER2     : org = 0x48040000 len =_
50 ↪0x0000005C      CREGISTER=1
51      PWMSS0       : org = 0x48300000 len =_
52 ↪0x000002C4      CREGISTER=18
53      PWMSS1       : org = 0x48302000 len =_
54 ↪0x000002C4      CREGISTER=19
55      PWMSS2       : org = 0x48304000 len =_
56 ↪0x000002C4      CREGISTER=20
57      GEMAC        : org = 0x4A100000 len =_
58 ↪0x0000128C      CREGISTER=9
59      I2C1         : org = 0x4802A000 len =_
60 ↪0x000000D8      CREGISTER=2
61      I2C2         : org = 0x4819C000 len =_
62 ↪0x000000D8      CREGISTER=17
63      MBX0         : org = 0x480C8000 len =_
64 ↪0x00000140      CREGISTER=22
65      MCASPO_DMA   : org = 0x46000000 len =_
66 ↪0x00000100      CREGISTER=8
67      MCSPI0       : org = 0x48030000 len =_
68 ↪0x000001A4      CREGISTER=6
69      MCSPI1       : org = 0x481A0000 len =_
70 ↪0x000001A4      CREGISTER=16
71      MMCHS0       : org = 0x48060000 len =_
72 ↪0x00000300      CREGISTER=5
73      SPINLOCK     : org = 0x480CA000 len =_
74 ↪0x00000880      CREGISTER=23
75      TPCC         : org = 0x49000000 len =_
76 ↪0x00001098      CREGISTER=29
77      UART1        : org = 0x48022000 len =_
78 ↪0x00000088      CREGISTER=11
79      UART2        : org = 0x48024000 len =_
80 ↪0x00000088      CREGISTER=12
81
82      RSVD10       : org = 0x48318000 len =_
83 ↪0x00000100      CREGISTER=10
84      RSVD13       : org = 0x48310000 len =_
85 ↪0x00000100      CREGISTER=13
86      RSVD21       : org = 0x00032400 len =_
87 ↪0x00000100      CREGISTER=21
88      RSVD27       : org = 0x00032000 len =_
89 ↪0x00000100      CREGISTER=27

```

(continues on next page)

```

63 }
64 }
65
66 /* Specify the sections allocation into memory */
67 SECTIONS {
68     /* Forces _c_int00 to the start of PRU IRAM. Not necessary when
69     →loading
70     an ELF file, but useful when loading a binary */
71     .text:_c_int00* > 0x0, PAGE 0
72
73     .text > PRU_IMEM, PAGE 0
74     .stack > PRU_DMEM_0_1, PAGE 1
75     .bss > PRU_DMEM_0_1, PAGE 1
76     .cio > PRU_DMEM_0_1, PAGE 1
77     .data > PRU_DMEM_0_1, PAGE 1
78     .switch > PRU_DMEM_0_1, PAGE 1
79     .system > PRU_DMEM_0_1, PAGE 1
80     .cinit > PRU_DMEM_0_1, PAGE 1
81     .rodata > PRU_DMEM_0_1, PAGE 1
82     .rofardata > PRU_DMEM_0_1, PAGE 1
83     .farbss > PRU_DMEM_0_1, PAGE 1
84     .farfardata > PRU_DMEM_0_1, PAGE 1
85
86     .resource_table > PRU_DMEM_0_1, PAGE 1
87     .init_pins > PRU_DMEM_0_1, PAGE 1
88 }

```

am335x_pru.cmd

Todo: does this need updating?

The cmd file for the AI is about the same, with appropriate addresses for the AI.

3.7.3 Discussion

The important things to notice in the file are given in the following table.

AM335x_PRU.cmd important things

Line	Explanation
16	This is where the instructions are stored. See page 206 of the AM335x Technical Reference Manual rev. P Or see page 417 of AM572x Technical Reference Manual for the AI.
22	This is where PRU 0's DMEM 0 is mapped. It's also where PRU 1's DMEM 1 is mapped.
23	The reverse to above. PRU 0's DMEM 1 appears here and PRU 1's DMEM 0 is here.
26	The shared memory for both PRU's appears here.
72	The <code>.text</code> section is where the code goes. It's mapped to <code>IMEM</code>
73	The <code>((stack))</code> is then mapped to DMEM 0. Notice that DMEM 0 is one bank of memory for PRU 0 and another for PRU1, so they both get their own stacks.
74	The <code>.bss</code> section is where the heap goes.

Why is it important to understand this file? If you are going to store things in DMEM, you need to be sure to start at address 0x0200 since the **stack** and the **heap** are in the locations below 0x0200.

3.8 Loading Firmware

3.8.1 Problem

I have my PRU code all compiled and need to load it on the PRU.

3.8.2 Solution

It's a simple three step process.

- Stop the PRU
- Write the `.out` file to the right place in `/lib/firmware`
- Start the PRU.

This is all handled in the [The Standard Makefile](#).

3.8.3 Discussion

The PRUs appear in the Linux file space at `/dev/remoteproc/`.

Finding the PRUs

```
bone$ cd /dev/remoteproc/
bone$ ls
pruss-core0 pruss-core1
```

Or if you are on the AI:

```
bone$ cd /dev/remoteproc/
bone$ ls
dsp1 dsp2 ipu1 ipu2 pruss1-core0 pruss1-core1 pruss2-core0 pruss2-
→core1
```

You see there that the AI has two pairs of PRUs, plus a couple of DSPs and other goodies.

Here we see PRU 0 and PRU 1 in the path. Let's follow PRU 0.

```
bone$ cd pruss-core0
bone$ ls
device firmware name power state subsystem uevent
```

Here we see the files that control PRU 0. `firmware` tells where in `/lib/firmware` to look for the code to run on the PRU.

```
bone$ cat firmware
am335x-pru0-fw
```

Therefore you copy your `.out` file to `/lib/firmware/am335x-pru0-fw`.

3.9 Configuring Pins for Controlling Servos

3.9.1 Problem

You want to **configure** the pins so the PRU outputs are accessible.

3.9.2 Solution

It depends on which Beagle you are running on. If you are on the AI or Blue, everything is already configured for you. If you are on the Black or Pocket you'll need to run the following script.

Listing 3.4: servos_setup.sh

```
1 #!/bin/bash
2 # Configure the PRU pins based on which Beagle is running
3 machine=$(awk '{print $NF}' /proc/device-tree/model)
4 echo -n $machine
5 if [ $machine = "Black" ]; then
6     echo " Found"
7     pins="P8_27 P8_28 P8_29 P8_30 P8_39 P8_40 P8_41 P8_42"
8 elif [ $machine = "Blue" ]; then
9     echo " Found"
10    pins=""
11 elif [ $machine = "PocketBeagle" ]; then
12    echo " Found"
13    pins="P2_35 P1_35 P1_02 P1_04"
14 else
15    echo " Not Found"
16    pins=""
17 fi
18
19 for pin in $pins
20 do
21    echo $pin
22    config-pin $pin pruout
23    config-pin -q $pin
24 done
```

`servos_setup.sh`

3.9.3 Discussion

The first part of the code looks in `/proc/device-tree/model` to see which Beagle is running. Based on that it assigns `pins` a list of pins to configure. Then the last part of the script loops through each of the pins and configures it.

3.10 Configuring Pins for Controlling Encoders

3.10.1 Problem

You want to **configure** the pins so the PRU inputs are accessible.

3.10.2 Solution

It depends on which Beagle you are running on. If you are on the AI or Blue, everything is already configured for you. If you are on the Black or Pocket you'll need to run the following script.

Listing 3.5: encoder_setup.sh

```
1 #!/bin/bash
2 # Configure the pins based on which Beagle is running
3 machine=$(awk '{print $NF}' /proc/device-tree/model)
4 echo -n $machine
```

(continues on next page)

(continued from previous page)

```

5
6 # Configure eQEP pins
7 if [ $machine = "Black" ]; then
8     echo " Found"
9     pins="P9_92 P9_27 P8_35 P8_33 P8_12 P8_11 P8_41 P8_42"
10 elif [ $machine = "Blue" ]; then
11     echo " Found"
12     pins=""
13 elif [ $machine = "PocketBeagle" ]; then
14     echo " Found"
15     pins="P1_31 P2_34 P2_10 P2_24 P2_33"
16 else
17     echo " Not Found"
18     pins=""
19 fi
20
21 for pin in $pins
22 do
23     echo $pin
24     config-pin $pin qep
25     config-pin -q $pin
26 done
27
28 #####
29 # Configure PRU pins
30 if [ $machine = "Black" ]; then
31     echo " Found"
32     pins="P8_16 P8_15"
33 elif [ $machine = "Blue" ]; then
34     echo " Found"
35     pins=""
36 elif [ $machine = "PocketBeagle" ]; then
37     echo " Found"
38     pins="P2_09 P2_18"
39 else
40     echo " Not Found"
41     pins=""
42 fi
43
44 for pin in $pins
45 do
46     echo $pin
47     config-pin $pin pruin
48     config-pin -q $pin
49 done

```

encoder_setup.sh

3.10.3 Discussion

This works like the servo setup except some of the pins are configured as to the hardware eQEPs and other to the PRU inputs.

Chapter 4

Debugging and Benchmarking

One of the challenges is getting debug information out of the PRUs since they don't have a traditional `printf()`. In this chapter four different methods are presented that I've found useful in debugging. The first is simply attaching an LED. The second is using `dmesg` to watch the kernel messages. `prudebug`, a simple debugger that allows you to inspect registers and memory of the PRUs, is then presented. Finally, using one of the UARTS to send debugging information out a serial port is shown.

4.1 Debugging via an LED

4.1.1 Problem

I need a simple way to see if my program is running without slowing the real-time execution.

4.1.2 Solution

One of the simplest ways to do this is to attach an LED to the output pin and watch it flash. [LED used for debugging P9_29](#) shows an LED attached to pin P9_29 of the BeagleBone Black.

Make sure you have the LED in the correct way, or it won't work.

4.1.3 Discussion

If your output is changing more than a few times a second, the LED will be blinking too fast and you'll need an oscilloscope or a logic analyzer to see what's happening.

Another useful tool that let's you see the contents of the registers and RAM is discussed in [prudebug - A Simple Debugger for the PRU](#).

4.2 dmesg Hw

4.2.1 Problem

I'm getting an error message (`/sys/devices/platform/ocp/4a326000.pruss-soc-bus/4a300000.pruss/4a334000.pru0/remoteproc/remoteproc1/state: Invalid argument`) when I load my code, but don't know what's causing it.

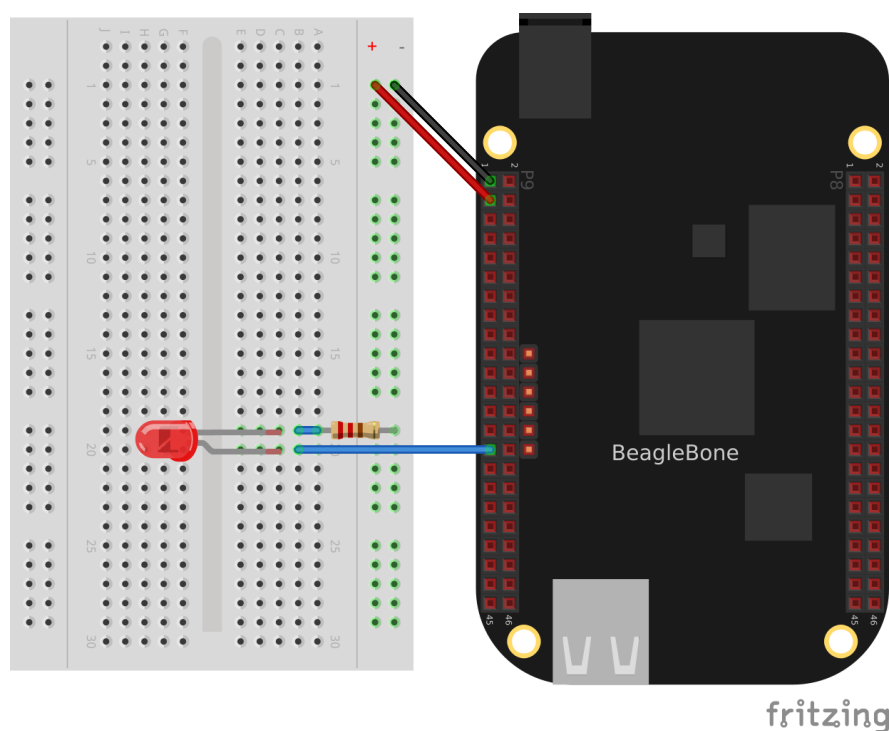

Fig. 4.1: LED used for debugging P9_29

4.2.2 Solution

The command `dmesg` outputs useful information when dealing with the kernel. Simply running `dmesg -Hw` can tell you a lot. The `-H` flag puts the dates in the human readable form, the `-w` tells it to wait for more information. Often I'll have a window open running `dmesg -Hw`.

Here's what `dmesg` said for the example above.

4.3 dmesg -Hw

```
[ +0.000018] remoteproc remoteproc1: header-less resource table
[ +0.011879] remoteproc remoteproc1: Failed to find resource table
[ +0.008770] remoteproc remoteproc1: Boot failed: -22
```

It quickly told me I needed to add the line `#include "resource_table_empty.h"` to my code.

4.4 prudebug - A Simple Debugger for the PRU

4.4.1 Problem

You need to examine registers and memory on the PRUs.

4.4.2 Solution

`prudebug` is a simple debugger for the PRUs that lets you start and stop the PRUs and examine the registers and memory. It can be found on GitHub <https://github.com/RRvW/prudebug-rl>. I have a version I updated to use byte addressing rather than word addressing. This makes it easier to work with the assembler output. You

can find it in my GitHub BeagleBoard repo <https://github.com/MarkAYoder/BeagleBoard-exercises/tree/master/pru/prudebug>.

Just download the files and type make.

4.4.3 Discussion

Once prudebug is installed is rather easy to use.

Note: prudebug has now been ported to the AI.

Todo: Isn't working on Pocket at this time.

```
bone$ *sudo prudebug*
PRU Debugger v0.25
(C) Copyright 2011, 2013 by Arctica Technologies. All rights reserved.
Written by Steven Anderson

Using /dev/mem device.
Processor type          AM335x
PRUSS memory address   0x4a300000
PRUSS memory length    0x00080000

      offsets below are in 32-bit byte addresses (not ARM byte addresses)
PRU      Instruction      Data      Ctrl
0        0x00034000      0x00000000 0x00022000
1        0x00038000      0x00002000 0x00024000
```

You get help by entering help. You can also enter hb to get a brief help.

```
PRU0> *hb*
Command help

BR [breakpoint_number [address]] - View or set an instruction breakpoint
D memory_location_ba [length] - Raw dump of PRU data memory (32-bit byte
↳offset from beginning of full PRU memory block - all PRUs)
DD memory_location_ba [length] - Dump data memory (32-bit byte offset
↳from beginning of PRU data memory)
DI memory_location_ba [length] - Dump instruction memory (32-bit byte
↳offset from beginning of PRU instruction memory)
DIS memory_location_ba [length] - Disassemble instruction memory (32-bit
↳byte offset from beginning of PRU instruction memory)
G - Start processor execution of instructions (at current IP)
GSS - Start processor execution using automatic single stepping - this
↳allows running a program with breakpoints
HALT - Halt the processor
L memory_location_iwa file_name - Load program file into instruction
↳memory
PRU pru_number - Set the active PRU where pru_number ranges from 0 to 1
Q - Quit the debugger and return to shell prompt.
R - Display the current PRU registers.
RESET - Reset the current PRU
SS - Single step the current instruction.
WA [watch_num [address [value]]] - Clear or set a watch point
WR memory_location_ba value1 [value2 [value3 ...]] - Write a 32-bit
↳value to a raw (offset from beginning of full PRU memory block)
WRD memory_location_ba value1 [value2 [value3 ...]] - Write a 32-bit
↳value to PRU data memory for current PRU
```

(continues on next page)

(continued from previous page)

```
WRI memory_location_ba value1 [value2 [value3 ...]] - Write a 32-bit
→value to PRU instruction memory for current PRU
```

Initially you are talking to PRU 0. You can enter `pru 1` to talk to PRU 1. The commands I find most useful are, `r`, to see the registers.

```
PRU0> *r*
Register info for PRU0
  Control register: 0x00008003
  Reset PC:0x0000 RUNNING, FREE_RUN, COUNTER_DISABLED, NOT_SLEEPING,
→PROC_ENABLED

  Program counter: 0x0030
  Current instruction: ADD R0.b0, R0.b0, R0.b0

  Rxx registers not available since PRU is RUNNING.
```

Notice the PRU has to be stopped to see the register contents.

```
PRU0> *h*
PRU0 Halted.
PRU0> *r*
Register info for PRU0
  Control register: 0x00000001
  Reset PC:0x0000 STOPPED, FREE_RUN, COUNTER_DISABLED, NOT_SLEEPING,
→PROC_DISABLED

  Program counter: 0x0028
  Current instruction: LBBO R15, R15, 4, 4

  R00: 0x00000000    R08: 0x00000000    R16: 0x00000001    R24: 0x00000002
  R01: 0x00000000    R09: 0xaf40dcf2    R17: 0x00000000    R25: 0x00000003
  R02: 0x000000dc    R10: 0xd8255b1b   R18: 0x00000003    R26: 0x00000003
  R03: 0x000f0000    R11: 0xc50cbefd   R19: 0x00000100    R27: 0x00000002
  R04: 0x00000000    R12: 0xb037c0d7   R20: 0x00000100    R28: 0x8ca9d976
  R05: 0x00000009    R13: 0xf48bbe23   R21: 0x441fb678    R29: 0x00000002
  R06: 0x00000000    R14: 0x00000134   R22: 0xc8cc0752    R30: 0x00000000
  R07: 0x00000009    R15: 0x00000200   R23: 0xe346fee9    R31: 0x00000000
```

You can resume using `g` which starts right where you left off, or use `reset` to restart back at the beginning.

The `dd` command dumps the memory. Keep in mind the following.

Table 4.1: Important memory locations

Address	Contents
0x00000	Start of the stack for PRU 0. The file AM335x_PRU.cmd specifies where the stack is.
0x00100	Start of the heap for PRU 0.
0x00200	Start of DRAM that your programs can use. The Makefile specifies the size of the stack and the heap .
0x10000	Start of the memory shared between the PRUs.

Using `dd` with no address prints the next section of memory.

```
PRU0> *dd*
dd
Absolute addr = 0x0000, offset = 0x0000, Len = 16
[0x0000] 0x00000000 0x00000000 0x00000000 0x00000000
[0x0010] 0x00000000 0x00000000 0x00000000 0x00000000
[0x0020] 0x00000000 0x00000000 0x00000000 0x00000000
[0x0030] 0x00000000 0x00000000 0x00000000 0x00000000
```

The stack grows from higher memory to lower memory, so you often won't see much around address 0x0000.

```
PRU0> *dd 0x100*
dd 0x100
Absolute addr = 0x0100, offset = 0x0000, Len = 16
[0x0100] 0x00000001 0x00000002 0x00000003 0x00000004
[0x0110] 0x00000004 0x00000003 0x00000002 0x00000001
[0x0120] 0x00000001 0x00000000 0x00000000 0x00000000
[0x0130] 0x00000000 0x00000200 0x862e5c18 0xfef21aca
```

Here we see some values on the heap.

```
PRU0> *dd 0x200*
dd 0x200
Absolute addr = 0x0200, offset = 0x0000, Len = 16
[0x0200] 0x00000001 0x00000004 0x00000002 0x00000003
[0x0210] 0x00000003 0x00000011 0x00000004 0x00000010
[0x0220] 0x0a4fe833 0xb222ebda 0xe5575236 0xc50cbefd
[0x0230] 0xb037c0d7 0xf48bbe23 0x88c460f0 0x011550d4
```

Data written explicitly to 0x0200 of the DRAM.

```
PRU0> *dd 0x10000*
dd 0x10000
Absolute addr = 0x10000, offset = 0x0000, Len = 16
[0x10000] 0x8ca9d976 0xebcb119e 0x3aebce31 0x68c44d8b
[0x10010] 0xc370ba7e 0x2fea993b 0x15c67fa5 0xfbf68557
[0x10020] 0x5ad81b4f 0x4a55071a 0x48576eb7 0x1004786b
[0x10030] 0x2265ebc6 0xa27b32a0 0x340d34dc 0xbfa02d4b
```

Here's the shared memory.

You can also use prudebug to set breakpoints and single step, but I haven't used that feature much.

[Memory Allocation](#) gives examples of how you can control where your variables are stored in memory.

4.5 UART

4.5.1 Problem

I'd like to use something like `printf()` to debug my code.

Todo: Check these on the Black and Pocket without grove

4.5.2 Solution

One simple, yet effective approach to 'printing' from the PRU is an idea taken from the Arduino playbook; use the UART (serial port) to output debug information. The PRU has it's own UART that can send characters to a serial port.

You'll need a 3.3V FTDI cable to go between your Beagle and the USB port on your host computer as shown in [FTDI cable](#).¹ you can get such a cable from places such as [Sparkfun](#) or [Adafruit](#).

¹ FTDI images are from the BeagleBone Cookbook



Fig. 4.2: FTDI cable

4.5.3 Discussion

The Beagle side of the FTDI cable has a small triangle on it as shown in [FTDI connector](#) which marks the ground pin, pin 1.

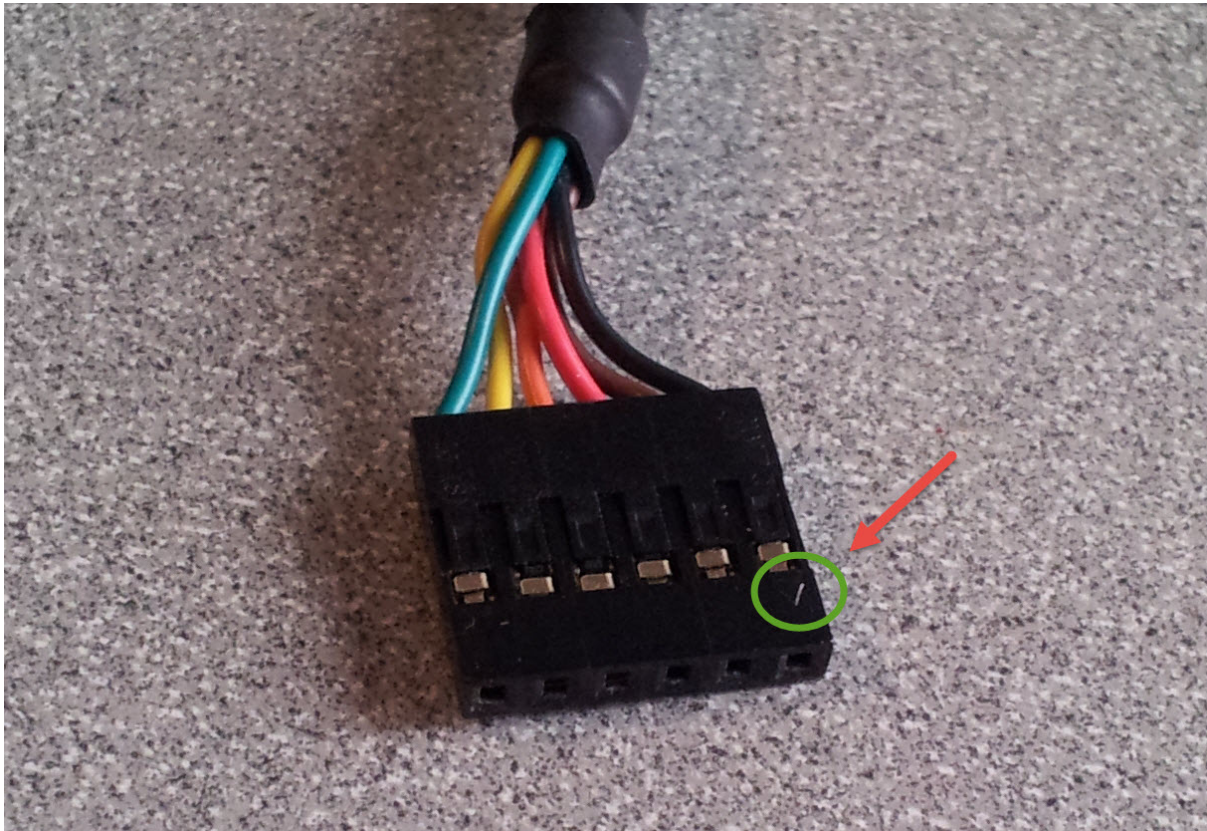

Fig. 4.3: FTDI connector

The [Wiring for FTDI cable to Beagle](#) table shows which pins connect where and [FTDI to BB Black](#) is a wiring diagram for the BeagleBone Black.

Table 4.2: Wiring for FTDI cable to Beagle

FTDI pin	Color	Black pin	AI 1 pin	AI 2 pin	Pocket	Function
0	black	P9_1	P8_1	P8_1	P1_16	ground
4	orange	P9_24	P8_43	P8_33a	P1_12	rx
5	yellow	P9_26	P8_44	P8_31a	P1_06	tx

4.5.4 Details

Two examples of using the UART are presented here. The first ([uart1.pru1_0.c](#)) sends a character out the serial port then waits for a character to come in. Once the new character arrives another character is output.

The second example ([uart2.pru1_0.c](#)) prints out a string and then waits for characters to arrive. Once an ENTER appears the string is sent back.

Tip: On the Black, either PRU0 and PRU1 can run this code. Both have access to the same UART.

You need to set the pin muxes.

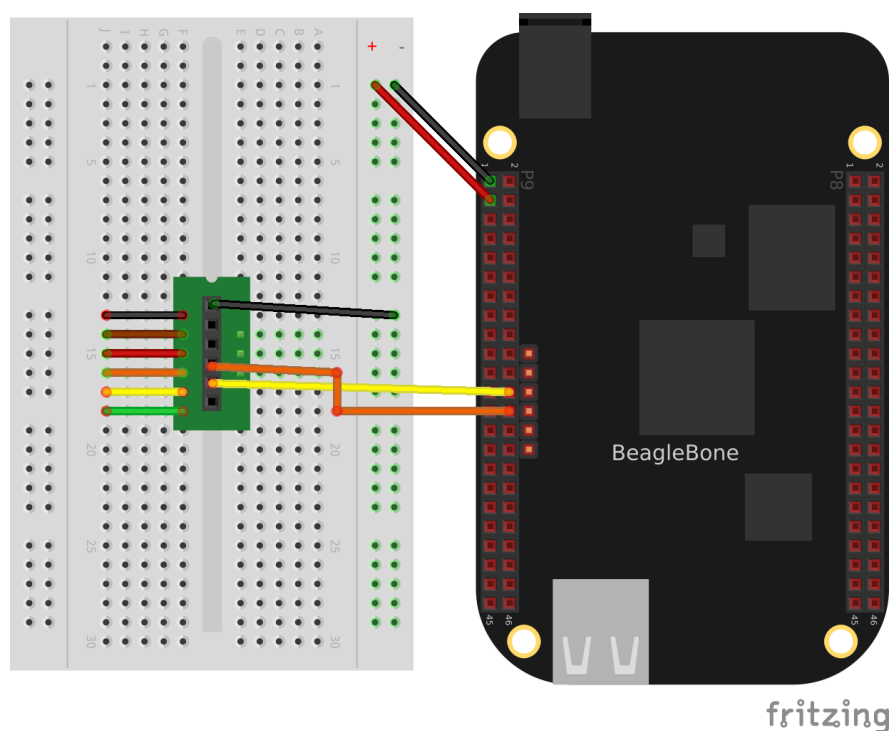

Fig. 4.4: FTDI to BB Black

4.5.5 config-pin

```
# Configure tx Black
bone$ *config-pin P9_24 pru_uart*
# Configure rx Black
bone$ *config-pin P9_26 pru_uart*

# Configure tx Pocket
bone$ *config-pin P1_06 pru_uart*
# Configure rx Pocket
bone$ *config-pin P1_12 pru_uart*
```

Note: See [Configuring pins on the AI via device trees](#) for configuring pins on the AI. Make sure your *rx* pins are configured as input pins in the device tree.

For example

```
DRA7XX_CORE_IOPAD(0x3610, *PIN_INPUT* | MUX_MODE10) // C6: P8.33a:
```

Todo: Add code for Blue.

Listing 4.1: uart1.pru1_0.c

```
1 // From: http://git.ti.com/pru-software-support-package/pru-software-support-
  ↳ package/trees/master/examples/am335x/PRU_Hardware_UART
2 // This example was converted to the am5729 by changing the names in pru_
  ↳ uart.h
3 // for the am335x to the more descriptive names for the am5729.
4 // For example DLL convertes to DIVISOR_REGISTER_LSB_
```

(continues on next page)

(continued from previous page)

```

5  #include <stdint.h>
6  #include <pru_uart.h>
7  #include "resource_table_empty.h"
8
9  /* The FIFO size on the PRU UART is 16 bytes; however, we are (arbitrarily)
10 * only going to send 8 at a time */
11 #define FIFO_SIZE      16
12 #define MAX_CHARS      8
13
14 void main(void)
15 {
16     uint8_t tx;
17     uint8_t rx;
18     uint8_t cnt;
19
20     /* hostBuffer points to the string to be printed */
21     char* hostBuffer;
22
23     /*** INITIALIZATION ***/
24
25     /* Set up UART to function at 115200 baud - DLL divisor is 104 at
↳16x oversample
26     * 192MHz / 104 / 16 = ~115200 */
27     CT_UART.DIVISOR_REGISTER_LSB_ = 104;
28     CT_UART.DIVISOR_REGISTER_MSB_ = 0;
29     CT_UART.MODE_DEFINITION_REGISTER = 0x0;
30
31     /* Enable Interrupts in UART module. This allows the main thread to
↳poll for
32     * Receive Data Available and Transmit Holding Register Empty */
33     CT_UART.INTERRUPT_ENABLE_REGISTER = 0x7;
34
35     /* If FIFOs are to be used, select desired trigger level and enable
36     * FIFOs by writing to FCR. FIFOEN bit in FCR must be set first
↳before
37     * other bits are configured */
38     /* Enable FIFOs for now at 1-byte, and flush them */
39     CT_UART.INTERRUPT_IDENTIFICATION_REGISTER_FIFO_CONTROL_REGISTER =
↳(0x8) | (0x4) | (0x2) | (0x1);
40     //CT_UART.FCR = (0x80) | (0x4) | (0x2) | (0x01); // 8-byte RX FIFO
↳trigger
41
42     /* Choose desired protocol settings by writing to LCR */
43     /* 8-bit word, 1 stop bit, no parity, no break control and no
↳divisor latch */
44     CT_UART.LINE_CONTROL_REGISTER = 3;
45
46     /* Enable loopback for test */
47     CT_UART.MODEM_CONTROL_REGISTER = 0x00;
48
49     /* Choose desired response to emulation suspend events by configuring
50     * FREE bit and enable UART by setting UTRST and URRST in PWREMU
↳MGMT */
51     /* Allow UART to run free, enable UART TX/RX */
52     CT_UART.POWERMANAGEMENT_AND_EMULATION_REGISTER = 0x6001;
53
54     /*** END INITIALIZATION ***/
55
56     /* Priming the 'hostbuffer' with a message */
57     hostBuffer = "Hello! This is a long string\r\n";
58

```

(continues on next page)

(continued from previous page)

```

59     /** SEND SOME DATA **/
60
61     /* Let's send/receive some dummy data */
62     while(1) {
63         cnt = 0;
64         while(1) {
65             /* Load character, ensure it is not string_
66             ↪ termination */
67             if ((tx = hostBuffer[cnt]) == '\0')
68                 break;
69             cnt++;
70             CT_UART.RBR_THR_REGISTERS = tx;
71
72             /* Because we are doing loopback, wait until LSR.DR_
73             ↪ == 1
74
75              * indicating there is data in the RX FIFO */
76             while ((CT_UART.LINE_STATUS_REGISTER & 0x1) == 0x0);
77
78             /* Read the value from RBR */
79             rx = CT_UART.RBR_THR_REGISTERS;
80
81             /* Wait for TX FIFO to be empty */
82             while (!(CT_UART.INTERRUPT_IDENTIFICATION_REGISTER_
83             ↪ FIFO_CONTROL_REGISTER & 0x2) == 0x2));
84         }
85     }
86
87     /** DONE SENDING DATA **/
88
89     /* Disable UART before halting */
90     CT_UART.POWERMANAGEMENT_AND_EMULATION_REGISTER = 0x0;
91
92     /* Halt PRU core */
93     __halt();
94 }

```

uart1.pru1_0.c

Set the following variables so make will know what to compile.

Listing 4.2: make

```

bone$ *make TARGET=uart1.pru0*
/opt/source/pru-cookbook-code/common/Makefile:29: MODEL=TI_AM335x_BeagleBone_
↪ Black, TARGET=uart1.pru0
- Stopping PRU 0
- copying firmware file /tmp/vsx-examples/uart1.pru0.out to /lib/
↪ firmware/am335x-pru0-fw
write_init_pins.sh
- Starting PRU 0
MODEL    = TI_AM335x_BeagleBone_Black
PROC     = pru
PRUN    = 0
PRU_DIR  = /dev/remoteproc/pruss-core0

```

Now make will compile, load PRU0 and start it. In a terminal window on your host computer run

```
host$ *screen /dev/ttyUSB0 115200*
```

It will initially display the first characters (H) and then as you enter characters on the keyboard, the rest of the message will appear.

Here's the code (uart1.pru1_0.c) that does it.

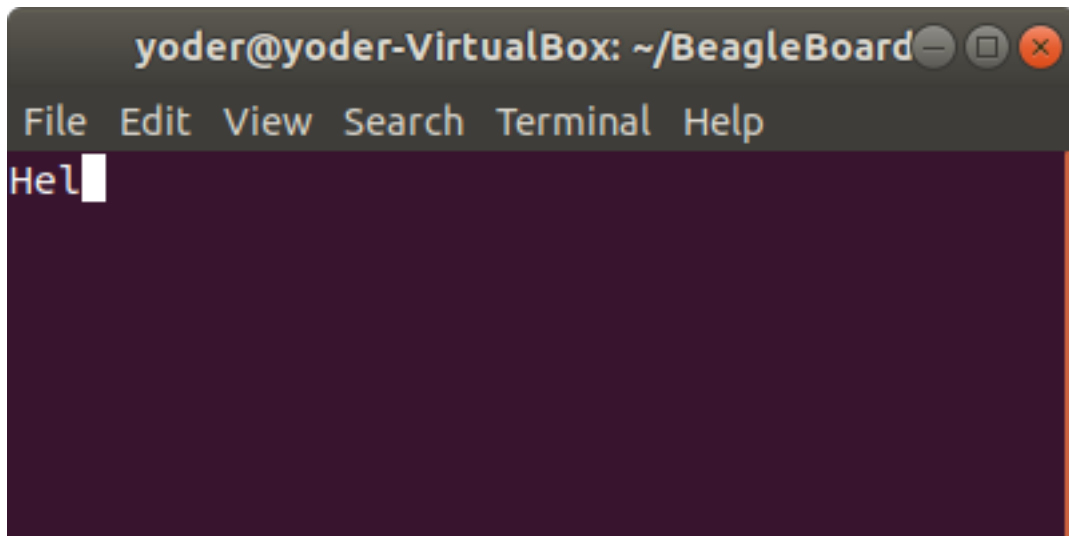

Fig. 4.5: uart1.pru0.c output

Listing 4.3: uart1.pru1_0.c

```

1 // From: http://git.ti.com/pru-software-support-package/pru-software-support-
2   ↳package/trees/master/examples/am335x/PRU_Hardware_UART
3 // This example was converted to the am5729 by changing the names in pru_
4   ↳uart.h
5 // for the am335x to the more descriptive names for the am5729.
6 // For example DLL convertes to DIVISOR_REGISTER_LSB_
7 #include <stdint.h>
8 #include <pru_uart.h>
9 #include "resource_table_empty.h"
10
11 /* The FIFO size on the PRU UART is 16 bytes; however, we are (arbitrarily)
12   * only going to send 8 at a time */
13 #define FIFO_SIZE      16
14 #define MAX_CHARS      8
15
16 void main(void)
17 {
18     uint8_t tx;
19     uint8_t rx;
20     uint8_t cnt;
21
22     /* hostBuffer points to the string to be printed */
23     char* hostBuffer;
24
25     /*** INITIALIZATION ***/
26
27     /* Set up UART to function at 115200 baud - DLL divisor is 104 at_
28   ↳16x oversample
29     * 192MHz / 104 / 16 = ~115200 */
30     CT_UART.DIVISOR_REGISTER_LSB_ = 104;
31     CT_UART.DIVISOR_REGISTER_MSB_ = 0;
32     CT_UART.MODE_DEFINITION_REGISTER = 0x0;
33
34     /* Enable Interrupts in UART module. This allows the main thread to_
35   ↳poll for
36     * Receive Data Available and Transmit Holding Register Empty */
37     CT_UART.INTERRUPT_ENABLE_REGISTER = 0x7;

```

(continues on next page)

(continued from previous page)

```

35     /* If FIFOs are to be used, select desired trigger level and enable
36     * FIFOs by writing to FCR. FIFOEN bit in FCR must be set first.
↳before
37     * other bits are configured */
38     /* Enable FIFOs for now at 1-byte, and flush them */
39     CT_UART.INTERRUPT_IDENTIFICATION_REGISTER_FIFO_CONTROL_REGISTER =
↳(0x8) | (0x4) | (0x2) | (0x1);
40     //CT_UART.FCR = (0x80) | (0x4) | (0x2) | (0x01); // 8-byte RX FIFO.
↳trigger
41
42     /* Choose desired protocol settings by writing to LCR */
43     /* 8-bit word, 1 stop bit, no parity, no break control and no
↳divisor latch */
44     CT_UART.LINE_CONTROL_REGISTER = 3;
45
46     /* Enable loopback for test */
47     CT_UART.MODEM_CONTROL_REGISTER = 0x00;
48
49     /* Choose desired response to emulation suspend events by configuring
50     * FREE bit and enable UART by setting UTRST and URRST in PWREMU_
↳MGMT */
51     /* Allow UART to run free, enable UART TX/RX */
52     CT_UART.POWERMANAGEMENT_AND_EMULATION_REGISTER = 0x6001;
53
54     /*** END INITIALIZATION ***/
55
56     /* Priming the 'hostbuffer' with a message */
57     hostBuffer = "Hello! This is a long string\r\n";
58
59     /*** SEND SOME DATA ***/
60
61     /* Let's send/receive some dummy data */
62     while(1) {
63         cnt = 0;
64         while(1) {
65             /* Load character, ensure it is not string
↳termination */
66             if ((tx = hostBuffer[cnt]) == '\0')
67                 break;
68             cnt++;
69             CT_UART.RBR_THR_REGISTERS = tx;
70
71             /* Because we are doing loopback, wait until LSR.DR_
↳== 1
72             * indicating there is data in the RX FIFO */
73             while ((CT_UART.LINE_STATUS_REGISTER & 0x1) == 0x0);
74
75             /* Read the value from RBR */
76             rx = CT_UART.RBR_THR_REGISTERS;
77
78             /* Wait for TX FIFO to be empty */
79             while (!(CT_UART.INTERRUPT_IDENTIFICATION_REGISTER_
↳FIFO_CONTROL_REGISTER & 0x2) == 0x2));
80         }
81     }
82
83     /*** DONE SENDING DATA ***/
84
85     /* Disable UART before halting */
86     CT_UART.POWERMANAGEMENT_AND_EMULATION_REGISTER = 0x0;
87

```

(continues on next page)

(continued from previous page)

```

88     /* Halt PRU core */
89     __halt();
90 }

```

uart1.pru1_0.c

Note: I'm using the AI version of the code since it uses variables with more descriptive names.

The first part of the code initializes the UART. Then the line `CT_UART.RBR_THR_REGISTERS = tx;` takes a character in `tx` and sends it to the transmit buffer on the UART. Think of this as the UART version of the `printf()`.

Later the line `while (!(CT_UART.INTERRUPT_IDENTIFICATION_REGISTER_FIFO_CONTROL_REGISTER & 0x2) == 0x2);` waits for the transmitter FIFO to be empty. This makes sure later characters won't overwrite the buffer before they can be sent. The downside is, this will cause your code to wait on the buffer and it might miss an important real-time event.

The line `while ((CT_UART.LINE_STATUS_REGISTER & 0x1) == 0x0);` waits for an input from the UART (possibly missing something) and `rx = CT_UART.RBR_THR_REGISTERS;` reads from the receive register on the UART.

These simple lines should be enough to place in your code to print out debugging information.

Listing 4.4: uart2.pru0.c

```

1 // From: http://git.ti.com/pru-software-support-package/pru-software-support-
2   ↪package/trees/master/pru_cape/pru_fw/PRU_Hardware_UART
3
4 #include <stdint.h>
5 #include <pru_uart.h>
6 #include "resource_table_empty.h"
7
8 /* The FIFO size on the PRU UART is 16 bytes; however, we are (arbitrarily)
9   * only going to send 8 at a time */
10 #define FIFO_SIZE      16
11 #define MAX_CHARS      8
12 #define BUFFER         40
13
14 //
15 ↪*****
16 //   Print Message Out
17 //   This function take in a string literal of any size and then fill the
18 //   TX FIFO when it's empty and waits until there is info in the RX FIFO
19 //   before returning.
20 //
21 ↪*****
22 void PrintMessageOut (volatile char* Message)
23 {
24     uint8_t cnt, index = 0;
25
26     while (1) {
27         cnt = 0;
28
29         /* Wait until the TX FIFO and the TX SR are completely empty.
30 ↪*/
31         while (!CT_UART.LSR_bit.TEMT);
32
33         while (Message[index] != NULL && cnt < MAX_CHARS) {
34             CT_UART.THR = Message[index];
35             index++;

```

(continues on next page)

```

32         cnt++;
33     }
34     if (Message[index] == NULL)
35         break;
36 }
37
38 /* Wait until the TX FIFO and the TX SR are completely empty */
39 while (!CT_UART.LSR_bit.TEMT);
40
41 }
42
43 //
44 →*****
45 // IEP Timer Config
46 // This function waits until there is info in the RX FIFO and then
47 →returns
48 // the first character entered.
49 //
50 →*****
51 char ReadMessageIn(void)
52 {
53     while (!CT_UART.LSR_bit.DR);
54
55     return CT_UART.RBR_bit.DATA;
56 }
57
58 void main(void)
59 {
60     uint32_t i;
61     volatile uint32_t not_done = 1;
62
63     char rxBuffer[BUFFER];
64     rxBuffer[BUFFER-1] = NULL; // null terminate the string
65
66     /*** INITIALIZATION ***/
67
68     /* Set up UART to function at 115200 baud - DLL divisor is 104 at
69 →16x oversample
70     * 192MHz / 104 / 16 = ~115200 */
71     CT_UART.DLL = 104;
72     CT_UART.DLH = 0;
73     CT_UART.MDR_bit.OSM_SEL = 0x0;
74
75     /* Enable Interrupts in UART module. This allows the main thread to
76 →poll for
77     * Receive Data Available and Transmit Holding Register Empty */
78     CT_UART.IER = 0x7;
79
80     /* If FIFOs are to be used, select desired trigger level and enable
81     * FIFOs by writing to FCR. FIFOEN bit in FCR must be set first
82 →before
83     * other bits are configured */
84     /* Enable FIFOs for now at 1-byte, and flush them */
85     CT_UART.FCR = (0x80) | (0x8) | (0x4) | (0x2) | (0x01); // 8-byte RX
86 →FIFO trigger
87
88     /* Choose desired protocol settings by writing to LCR */
89     /* 8-bit word, 1 stop bit, no parity, no break control and no
90 →divisor latch */
91     CT_UART.LCR = 3;
92
93
94

```

(continues on next page)

(continued from previous page)

```

85     /* If flow control is desired write appropriate values to MCR. */
86     /* No flow control for now, but enable loopback for test */
87     CT_UART.MCR = 0x00;
88
89     /* Choose desired response to emulation suspend events by configuring
90     * FREE bit and enable UART by setting UTRST and URRST in PWREMU_
91     →MGMT */
92     /* Allow UART to run free, enable UART TX/RX */
93     CT_UART.PWREMU_MGMT_bit.FREE = 0x1;
94     CT_UART.PWREMU_MGMT_bit.URRST = 0x1;
95     CT_UART.PWREMU_MGMT_bit.UTRST = 0x1;
96
97     /* Turn off RTS and CTS functionality */
98     CT_UART.MCR_bit.AFE = 0x0;
99     CT_UART.MCR_bit.RTS = 0x0;
100
101     /**** END INITIALIZATION ****/
102
103     while(1) {
104         /* Print out greeting message */
105         PrintMessageOut("Hello you are in the PRU UART demo test.
106         →please enter some characters\r\n");
107
108         /* Read in characters from user, then echo them back out */
109         for (i = 0; i < BUFFER-1 ; i++) {
110             rxBuffer[i] = ReadMessageIn();
111             if(rxBuffer[i] == '\r') {           // Quit early if
112         →ENTER is hit.
113
114                 rxBuffer[i+1] = NULL;
115                 break;
116             }
117         }
118
119         PrintMessageOut("you typed:\r\n");
120         PrintMessageOut(rxBuffer);
121         PrintMessageOut("\r\n");
122     }
123
124     /**** DONE SENDING DATA ****/
125     /* Disable UART before halting */
126     CT_UART.PWREMU_MGMT = 0x0;
127
128     /* Halt PRU core */
129     __halt();
130 }

```

uart2.pru0.c

If you want to try `uart2.pru0.c`, run the following:

Listing 4.5: make

```

bone$ *make TARGET=uart2.pru0*
/opt/source/pru-cookbook-code/common/Makefile:29: MODEL=TI_AM335x_BeagleBone_
→Black,TARGET=uart2.pru0
- Stopping PRU 0
- copying firmware file /tmp/vsx-examples/uart2.pru0.out to /lib/
→firmware/am335x-pru0-fw
write_init_pins.sh
- Starting PRU 0
MODEL = TI_AM335x_BeagleBone_Black
PROC = pru

```

(continues on next page)

(continued from previous page)

```
PRUN      = 0
PRU_DIR  = /dev/remoteproc/pruss-core0
```

You will see:

```
yoder@yoder-VirtualBox: ~/BeagleBoard
File Edit View Search Terminal Help
Hello you are in the PRU UART demo test please enter some characters
you typed:
This is a test!
Hello you are in the PRU UART demo test please enter some characters
█
```

Fig. 4.6: uart2.pru0.c output

Type a few characters and hit ENTER. The PRU will playback what you typed, but it won't echo it as you type.

uart2.pru0.c defines PrintMessageOut () which is passed a string that is sent to the UART. It takes advantage of the eight character FIFO on the UART. Be careful using it because it also uses while (!CT_UART.LSR_bit.TEMT) ; to wait for the FIFO to empty, which may cause your code to miss something.

uart2.pru1_0.c is the code that does it.

Listing 4.6: uart2.pru1_0.c

```
1 // From: http://git.ti.com/pru-software-support-package/pru-software-support-
2 ↪package/trees/master/pru_cape/pru_fw/PRU_Hardware_UART
3
4 #include <stdint.h>
5 #include <pru_uart.h>
6 #include "resource_table_empty.h"
7
8 /* The FIFO size on the PRU UART is 16 bytes; however, we are (arbitrarily)
9 * only going to send 8 at a time */
10 #define FIFO_SIZE      16
11 #define MAX_CHARS      8
12 #define BUFFER         40
13
14 //
15 ↪*****
16 //      Print Message Out
17 //      This function take in a string literal of any size and then fill the
18 //      TX FIFO when it's empty and waits until there is info in the RX FIFO
19 //      before returning.
20 //
21 ↪*****
22 void PrintMessageOut (volatile char* Message)
23 {
24     uint8_t cnt, index = 0;
25
26     while (1) {
27         cnt = 0;
```

(continues on next page)

(continued from previous page)

```

26         /* Wait until the TX FIFO and the TX SR are completely empty */
27         while (!CT_UART.LINE_STATUS_REGISTER_bit.TEMT);
28
29         while (Message[index] != NULL && cnt < MAX_CHARS) {
30             CT_UART.RBR_THR_REGISTERS = Message[index];
31             index++;
32             cnt++;
33         }
34         if (Message[index] == NULL)
35             break;
36     }
37
38     /* Wait until the TX FIFO and the TX SR are completely empty */
39     while (!CT_UART.LINE_STATUS_REGISTER_bit.TEMT);
40
41 }
42
43 //
44 // *****
45 // IEP Timer Config
46 // This function waits until there is info in the RX FIFO and then
47 // returns
48 // the first character entered.
49 // *****
50 char ReadMessageIn(void)
51 {
52     while (!CT_UART.LINE_STATUS_REGISTER_bit.DR);
53
54     return CT_UART.RBR_THR_REGISTERS_bit.DATA;
55 }
56
57 void main(void)
58 {
59     uint32_t i;
60     volatile uint32_t not_done = 1;
61
62     char rxBuffer[BUFFER];
63     rxBuffer[BUFFER-1] = NULL; // null terminate the string
64
65     /*** INITIALIZATION ***/
66
67     /* Set up UART to function at 115200 baud - DLL divisor is 104 at
68     16x oversample
69     * 192MHz / 104 / 16 = ~115200 */
70     CT_UART.DIVISOR_REGISTER_LSB_ = 104;
71     CT_UART.DIVISOR_REGISTER_MSB_ = 0;
72     CT_UART.MODE_DEFINITION_REGISTER_bit.OSM_SEL = 0x0;
73
74     /* Enable Interrupts in UART module. This allows the main thread to
75     poll for
76     * Receive Data Available and Transmit Holding Register Empty */
77     CT_UART.INTERRUPT_ENABLE_REGISTER = 0x7;
78
79     /* If FIFOs are to be used, select desired trigger level and enable
80     * FIFOs by writing to FCR. FIFOEN bit in FCR must be set first
81     before
82     * other bits are configured */
83     /* Enable FIFOs for now at 1-byte, and flush them */
84     CT_UART.INTERRUPT_IDENTIFICATION_REGISTER_FIFO_CONTROL_REGISTER =

```

(continues on next page)

(continued from previous page)

```

80     ↪ (0x80) | (0x8) | (0x4) | (0x2) | (0x01); // 8-byte RX FIFO trigger
81     /* Choose desired protocol settings by writing to LCR */
82     /* 8-bit word, 1 stop bit, no parity, no break control and no
83     ↪ divisor latch */
84     CT_UART.LINE_CONTROL_REGISTER = 3;
85     /* If flow control is desired write appropriate values to MCR. */
86     /* No flow control for now, but enable loopback for test */
87     CT_UART.MODEM_CONTROL_REGISTER = 0x00;
88
89     /* Choose desired response to emulation suspend events by configuring
90     * FREE bit and enable UART by setting UTRST and URRST in PWREMU_
91     ↪MGMT */
92     /* Allow UART to run free, enable UART TX/RX */
93     CT_UART.POWERMANAGEMENT_AND_EMULATION_REGISTER_bit.FREE = 0x1;
94     CT_UART.POWERMANAGEMENT_AND_EMULATION_REGISTER_bit.URRST = 0x1;
95     CT_UART.POWERMANAGEMENT_AND_EMULATION_REGISTER_bit.UTRST = 0x1;
96
97     /* Turn off RTS and CTS functionality */
98     CT_UART.MODEM_CONTROL_REGISTER_bit.AFE = 0x0;
99     CT_UART.MODEM_CONTROL_REGISTER_bit.RTS = 0x0;
100
101     /*** END INITIALIZATION ***/
102
103     while(1) {
104         /* Print out greeting message */
105         PrintMessageOut("Hello you are in the PRU UART demo test.
106         ↪please enter some characters\r\n");
107
108         /* Read in characters from user, then echo them back out */
109         for (i = 0; i < BUFFER-1 ; i++) {
110             rxBuffer[i] = ReadMessageIn();
111             if(rxBuffer[i] == '\r') { // Quit early if
112                 ↪ENTER is hit.
113                 rxBuffer[i+1] = NULL;
114                 break;
115             }
116         }
117
118         PrintMessageOut("you typed:\r\n");
119         PrintMessageOut(rxBuffer);
120         PrintMessageOut("\r\n");
121     }
122
123     /*** DONE SENDING DATA ***/
124     /* Disable UART before halting */
125     CT_UART.POWERMANAGEMENT_AND_EMULATION_REGISTER = 0x0;
126
127     /* Halt PRU core */
128     __halt();
129 }

```

uart2.pru1_0.c

More complex examples can be built using the principles shown in these examples.

Copyright

Listing 4.7: copyright.c

```
1 /*
2  * Copyright (C) 2015 Texas Instruments Incorporated - http://www.ti.com/
3  *
4  *
5  * Redistribution and use in source and binary forms, with or without
6  * modification, are permitted provided that the following conditions
7  * are met:
8  *
9  *     * Redistributions of source code must retain the above copyright
10 *       notice, this list of conditions and the following disclaimer.
11 *
12 *     * Redistributions in binary form must reproduce the above copyright
13 *       notice, this list of conditions and the following disclaimer in
14 *       the
15 *       documentation and/or other materials provided with the
16 *       distribution.
17 *
18 *     * Neither the name of Texas Instruments Incorporated nor the names
19 *       of
20 *       its contributors may be used to endorse or promote products
21 *       derived
22 *       from this software without specific prior written permission.
23 *
24 * THIS SOFTWARE IS PROVIDED BY THE COPYRIGHT HOLDERS AND CONTRIBUTORS
25 * "AS IS" AND ANY EXPRESS OR IMPLIED WARRANTIES, INCLUDING, BUT NOT
26 * LIMITED TO, THE IMPLIED WARRANTIES OF MERCHANTABILITY AND FITNESS FOR
27 * A PARTICULAR PURPOSE ARE DISCLAIMED. IN NO EVENT SHALL THE COPYRIGHT
28 * OWNER OR CONTRIBUTORS BE LIABLE FOR ANY DIRECT, INDIRECT, INCIDENTAL,
29 * SPECIAL, EXEMPLARY, OR CONSEQUENTIAL DAMAGES (INCLUDING, BUT NOT
30 * LIMITED TO, PROCUREMENT OF SUBSTITUTE GOODS OR SERVICES; LOSS OF USE,
31 * DATA, OR PROFITS; OR BUSINESS INTERRUPTION) HOWEVER CAUSED AND ON ANY
32 * THEORY OF LIABILITY, WHETHER IN CONTRACT, STRICT LIABILITY, OR TORT
33 * (INCLUDING NEGLIGENCE OR OTHERWISE) ARISING IN ANY WAY OUT OF THE USE
34 * OF THIS SOFTWARE, EVEN IF ADVISED OF THE POSSIBILITY OF SUCH DAMAGE.
35 */
```

copyright.c

Chapter 5

Building Blocks - Applications

Here are some examples that use the basic PRU building blocks.

The following are resources used in this chapter.

Note: *Resources*

- PRU Optimizing C/C++ Compiler, v2.2, User's Guide
 - AM572x Technical Reference Manual (AI)
 - AM335x Technical Reference Manual (All others)
 - Exploring BeagleBone by Derek Molloy
 - WS2812 Data Sheet
-

5.1 Memory Allocation

5.1.1 Problem

I want to control where my variables are stored in memory.

Todo: Include a section on accessing DDR.

5.1.2 Solution

Each PRU has its own 8KB of data memory (Data Mem0 and Mem1) and 12KB of shared memory (Shared RAM) as shown in [PRU Block Diagram](#).

Each PRU accesses its own DRAM starting at location 0x0000_0000. Each PRU can also access the other PRU's DRAM starting at 0x0000_2000. Both PRUs access the shared RAM at 0x0001_0000. The compiler can control where each of these memories variables are stored.

[shared.pro.c - Examples of Using Different Memory Locations](#) shows how to allocate seven variable in six different locations.

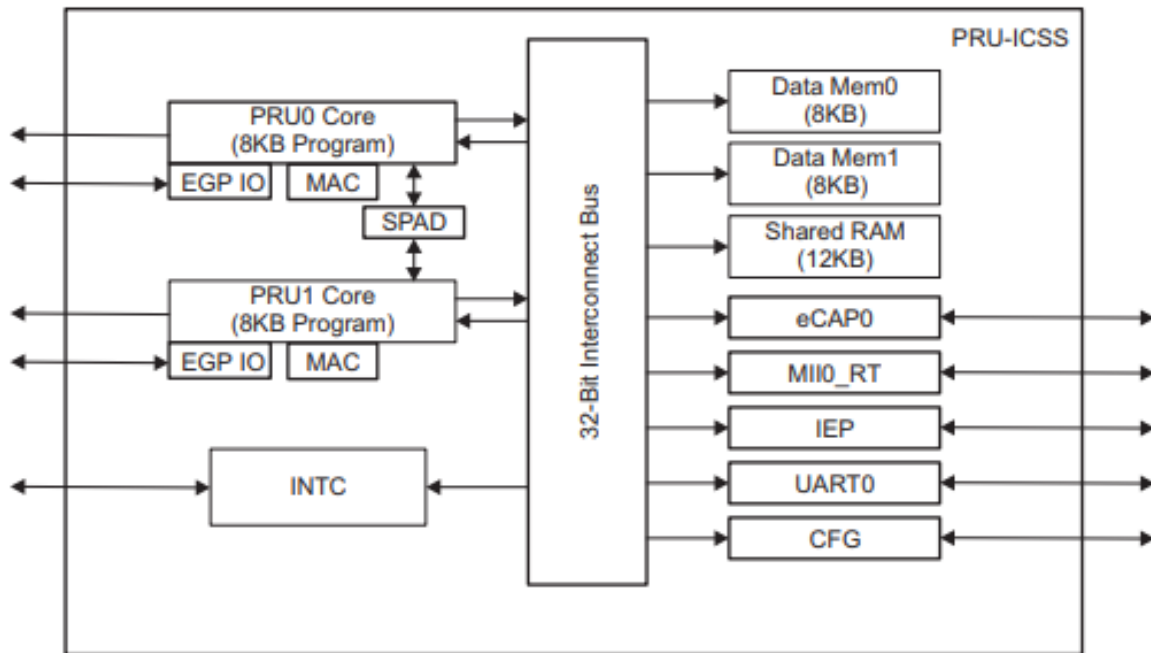

Fig. 5.1: PRU Block Diagram

Listing 5.1: shared.pro0.c - Examples of Using Different Memory Locations

```

1 // From: http://git.ti.com/pru-software-support-package/pru-software-support-
  ↳ package/blobs/master/examples/am335x/PRU_access_const_table/PRU_access_
  ↳ const_table.c
2 #include <stdint.h>
3 #include <pru_cfg.h>
4 #include <pru_ctrl.h>
5 #include "resource_table_empty.h"
6
7 #define PRU_SRAM __far __attribute__((register("PRU_SHAREDMEM", near)))
8 #define PRU_DMEM0 __far __attribute__((register("PRU_DMEM_0_1", near)))
9 #define PRU_DMEM1 __far __attribute__((register("PRU_DMEM_1_0", near)))
10
11 /* NOTE: Allocating shared_x to PRU Shared Memory means that other PRU_
  ↳ cores on
12 * the same subsystem must take care not to allocate data to that_
  ↳ memory.
13 * Users also cannot rely on where in shared memory these_
  ↳ variables are placed
14 * so accessing them from another PRU core or from the ARM is an_
  ↳ undefined behavior.
15 */
16 volatile uint32_t shared_0;
17 PRU_SRAM volatile uint32_t shared_1;
18 PRU_DMEM0 volatile uint32_t shared_2;
19 PRU_DMEM1 volatile uint32_t shared_3;
20 #pragma DATA_SECTION(shared_4, ".bss")
21 volatile uint32_t shared_4;
22
23 /* NOTE: Here we pick where in memory to store shared_5. The stack and
  ↳ heap take up the first 0x200 words, so we must start_
  ↳ after that.

```

(continues on next page)

(continued from previous page)

```

25  *           Since we are hardcoding where things are stored we can_
↳share
26  *           this between the PRUs and the ARM.
27  */
28  #define PRU0_DRAM           0x00000           // Offset to_
↳DRAM
29  // Skip the first 0x200 bytes of DRAM since the Makefile allocates
30  // 0x100 for the STACK and 0x100 for the HEAP.
31  volatile unsigned int *shared_5 = (unsigned int *) (PRU0_DRAM + 0x200);
32
33
34  int main(void)
35  {
36      volatile uint32_t shared_6;
37      volatile uint32_t shared_7;
38      /* Access PRU peripherals using Constant Table & PRU header file */
39      /* Access PRU Shared RAM using Constant Table */
40      /* Clear SYSCFG[STANDBY_INIT] to enable OCP master port */
41
42      CT_CFG.SYSCFG_bit.STANDBY_INIT = 0;
43
44      /* Access PRU Shared RAM using Constant Table */
45      /* Access PRU Shared RAM using Constant Table */
46      /* Access PRU Shared RAM using Constant Table */
47      /* Access PRU Shared RAM using Constant Table */
48
49      /* C28 defaults to 0x00000000, we need to set bits 23:8 to 0x0100 in_
↳order to have it point to 0x00010000 */
50      PRU0_CTRL.CTPPR0_bit.C28_BLK_POINTER = 0x0100;
51
52      shared_0 = 0xfeef;
53      shared_1 = 0xdeadbeef;
54      shared_2 = shared_2 + 0xfeed;
55      shared_3 = 0xdeed;
56      shared_4 = 0xbeed;
57      shared_5[0] = 0x1234;
58      shared_6 = 0x4321;
59      shared_7 = 0x9876;
60
61      /* Halt PRU core */
62      __halt();
63  }

```

shared.pru0.c

5.1.3 Discussion

Here's the line-by-line

Table 5.1: Line-by-line for shared.pru0.c

Line	Explanation
7	<i>PRU_SRAM</i> is defined here. It will be used later to declare variables in the <i>Shared RAM</i> location of memory. Section 5.5.2 on page 75 of the <i>PRU Optimizing C/C++ Compiler, v2.2, User's Guide</i> gives details of the command. The <i>PRU_SHAREDMEM</i> refers to the memory section defined in <i>am335x_pru.cmd</i> on line 26.
8, 9	These are like the previous line except for the DMEM sections.
16	Variables declared outside of <i>main()</i> are put on the heap.
17	Adding <i>PRU_SRAM</i> has the variable stored in the shared memory.
18, 19	These are stored in the PRU's local RAM.
20, 21	These lines are for storing in the <i>.bss</i> section as declared on line 74 of <i>am335x_pru.cmd</i> .
28-31	All the previous examples direct the compiler to an area in memory and the compilers figures out what to put where. With these lines we specify the exact location. Here are start with the <i>PRU_DRAM</i> starting address and add 0x200 to it to avoid the stack and the heap . The advantage of this technique is you can easily share these variables between the ARM and the two PRUs.
36, 37	Variable declared inside <i>main()</i> go on the stack.

Caution: Using the technique of line 28-31 you can put variables anywhere, even where the compiler has put them. Be careful, it's easy to overwrite what the compiler has done

Compile and run the program.

```
bone$ *source shared_setup.sh*
TARGET=shared.pru0
Black Found
P9_31
Current mode for P9_31 is:      prout
Current mode for P9_31 is:      prout
P9_29
Current mode for P9_29 is:      prout
Current mode for P9_29 is:      prout
P9_30
Current mode for P9_30 is:      prout
Current mode for P9_30 is:      prout
P9_28
Current mode for P9_28 is:      prout
Current mode for P9_28 is:      prout
bone$ *make*
/opt/source/pru-cookbook-code/common/Makefile:29: MODEL=TI_AM335x_BeagleBone_
->Black, TARGET=shared.pru0
-   Stopping PRU 0
-   copying firmware file /tmp/vsx-examples/shared.pru0.out to /lib/
->firmware/am335x-pru0-fw
write_init_pins.sh
-   Starting PRU 0
MODEL    = TI_AM335x_BeagleBone_Black
PROC     = pru
PRUN     = 0
PRU_DIR  = /sys/class/remoteproc/remoteproc1
```

Now check the **symbol table** to see where things are allocated.

```
bone $ *grep shared /tmp/vsx-examples/shared.pru0.map*
....
1      0000011c  shared_0
2      00010000  shared_1
1      00000000  shared_2
1      00002000  shared_3
```

(continues on next page)

(continued from previous page)

```
1 00000118 shared_4
1 00000120 shared_5
```

We see, `shared_0` had no directives and was placed in the heap that is `0x100` to `0x1ff`. `shared_1` was directed to go to the `SHAREDMEM`, `shared_2` to the start of the local DRAM (which is also the top of the stack). `shared_3` was placed in the DRAM of PRU 1, `shared_4` was placed in the `.bss` section, which is in the **heap**. Finally `shared_5` is a pointer to where the value is stored.

Where are `shared_6` and `shared_7`? They are declared inside `main()` and are therefore placed on the stack at run time. The `shared.map` file shows the compile time allocations. We have to look in the memory itself to see what happens at run time.

Let's fire up `prudebug` ([prudebug - A Simple Debugger for the PRU](#)) to see where things are.

```
bone$ *sudo ./prudebug*
PRU Debugger v0.25
(C) Copyright 2011, 2013 by Arctica Technologies. All rights reserved.
Written by Steven Anderson

Using /dev/mem device.
Processor type           AM335x
PRUSS memory address    0x4a300000
PRUSS memory length     0x00080000

    offsets below are in 32-bit byte addresses (not ARM byte addresses)
PRU      Instruction      Data      Ctrl
0        0x00034000      0x00000000 0x00022000
1        0x00038000      0x00002000 0x00024000

PRU0> *d 0*
Absolute addr = 0x0000, offset = 0x0000, Len = 16
[0x0000] 0x0000feed 0x00000000 0x00000000 0x00000000
[0x0010] 0x00000000 0x00000000 0x00000000 0x00000000
[0x0020] 0x00000000 0x00000000 0x00000000 0x00000000
[0x0030] 0x00000000 0x00000000 0x00000000 0x00000000
```

The value of `shared_2` is in memory location 0.

```
PRU0> *dd 0x100*
Absolute addr = 0x0100, offset = 0x0000, Len = 16
[0x0100] 0x00000000 0x00000001 0x00000000 0x00000000
[0x0110] 0x00000000 0x00000000 0x0000beed 0x0000feef
[0x0120] 0x00000200 0x3ec71de3 0x1a013e1a 0xbf2a01a0
[0x0130] 0x111110b0 0x3f811111 0x55555555 0xbfc55555
```

There are `shared_0` and `shared_4` in the heap, but where is `shared_6` and `shared_7`? They are supposed to be on the **stack** that starts at 0.

```
PRU0> dd *0xc0*
Absolute addr = 0x00c0, offset = 0x0000, Len = 16
[0x00c0] 0x00000000 0x00000000 0x00000000 0x00000000
[0x00d0] 0x00000000 0x00000000 0x00000000 0x00000000
[0x00e0] 0x00000000 0x00000000 0x00000000 0x00000000
[0x00f0] 0x00000000 0x00000000 0x00004321 0x00009876
```

There they are; the stack grows from the top. (The heap grows from the bottom.)

```
PRU0> dd *0x2000*
Absolute addr = 0x2000, offset = 0x0000, Len = 16
[0x2000] 0x0000deed 0x00000001 0x00000000 0x557fcfb5
[0x2010] 0xce97bd0f 0x6afb2c8f 0xc7f35df4 0x5afb6dcb
```

(continues on next page)

(continued from previous page)

```
[0x2020] 0x8dec3da3 0xe39a6756 0x642cb8b8 0xcb6952c0
[0x2030] 0x2f22ebda 0x548d97c5 0x9241786f 0x72dfeb86
```

And there is PRU 1's memory with shared_3. And finally the shared memory.

```
PRU0> *dd 0x10000*
Absolute addr = 0x10000, offset = 0x0000, Len = 16
[0x10000] 0xdeadbeef 0x0000feed 0x00000000 0x68c44f8b
[0x10010] 0xc372ba7e 0x2ffa993b 0x11c66da5 0xfb6c5d7
[0x10020] 0x5ada3fcf 0x4a5d0712 0x48576fb7 0x1004796b
[0x10030] 0x2267ebc6 0xa2793aa1 0x100d34dc 0x9ca06d4a
```

The compiler offers great control over where variables are stored. Just be sure if you are hand picking where things are put, not to put them in places used by the compiler.

5.2 Auto Initialization of built-in LED Triggers

5.2.1 Problem

I see the built-in LEDs blink to their own patterns. How do I turn this off? Can this be automated?

5.2.2 Solution

Each built-in LED has a default action (trigger) when the Bone boots up. This is controlled by `/sys/class/leds`.

```
bone$ *cd /sys/class/leds*
bone$ *ls*
beaglebone:green:usr0  beaglebone:green:usr2
beaglebone:green:usr1  beaglebone:green:usr3
```

Here you see a directory for each of the LEDs. Let's pick USR1.

```
bone$ *cd beaglebone\:green\:usr1*
bone$ *ls*
brightness device max_brightness power subsystem trigger uevent
bone$ *cat trigger*
none usb-gadget usb-host rfkill-any rfkill-none kbd-scrolllock kbd-numlock
kbd-capslock kbd-kanalock kbd-shiftlock kbd-altgrlock kbd-ctrllock kbd-
→altlock
kbd-shiftllock kbd-shiftrlock kbd-ctrllllock kbd-ctrlrlock *[mmc0]* timer
oneshot disk-activity disk-read disk-write ide-disk mtd nand-disk heartbeat
backlight gpio cpu cpu0 activity default-on panic netdev phy0rx phy0tx
phy0assoc phy0radio rkill0
```

Notice `[mmc0]` is in brackets. This means it's the current trigger; it flashes when the built-in flash memory is in use. You can turn this off using:

```
bone$ *echo none > trigger*
bone$ *cat trigger*
*[none]* usb-gadget usb-host rfkill-any rfkill-none kbd-scrolllock kbd-
→numlock
kbd-capslock kbd-kanalock kbd-shiftlock kbd-altgrlock kbd-ctrllock kbd-
→altlock
kbd-shiftllock kbd-shiftrlock kbd-ctrllllock kbd-ctrlrlock mmc0 timer
oneshot disk-activity disk-read disk-write ide-disk mtd nand-disk heartbeat
backlight gpio cpu cpu0 activity default-on panic netdev phy0rx phy0tx
phy0assoc phy0radio rkill0
```

Now it is no longer flashing.

How can this be automated so when code is run that needs the trigger off, it's turned off automatically? Here's a trick. Include the following in your code.

```

1 #pragma DATA_SECTION(init_pins, ".init_pins")
2 #pragma RETAIN(init_pins)
3 const char init_pins[] =
4     "/sys/class/leds/beaglebone:green:usr3/trigger\0none\0" \
5     "\0\0";

```

Lines 3 and 4 declare the array `init_pins` to have an entry which is the path to `trigger` and the value that should be 'echoed' into it. Both are NULL terminated. Line 1 says to put this in a section called `.init_pins` and line 2 says to RETAIN it. That is don't throw it away if it appears to be unused.

5.2.3 Discussion

The above code stores this array in the `.out` file that's created, but that's not enough. You need to run [write_init_pins.sh](#) on the `.out` file to make the code work. Fortunately the Makefile always runs it.

Listing 5.2: write_init_pins.sh

```

1 #!/bin/bash
2 init_pins=$(readelf -x .init_pins $1 | grep 0x000 | cut -d' ' -f4-7 | xxd -r
↳ -p | tr '\0' '\n' | paste - -)
3 while read -a line; do
4     if [ ${#line[@]} == 2 ]; then
5         echo writing "${line[1]}" to "${line[0]}"
6         echo ${line[1]} > ${line[0]}
7         sleep 0.1
8     fi
9 done <<< "$init_pins"

```

write_init_pins.sh

The `readelf` command extracts the path and value from the `.out` file.

```

bone$ *readelf -x .init_pins /tmp/pru0-gen/shared.out*

Hex dump of section '.init_pins':
 0x000000c0 2f737973 2f636c61 73732f6c 6564732f /sys/class/leds/
 0x000000d0 62656167 6c65626f 6e653a67 7265656e beaglebone:green
 0x000000e0 3a757372 332f7472 69676765 72006e6f :usr3/trigger.no
 0x000000f0 6e650000 0000                                     ne....

```

The rest of the command formats it. Finally line 6 echos the `none` into the path.

This can be generalized to initialize other things. The point is, the `.out` file contains everything needed to run the executable.

5.3 PWM Generator

One of the simplest things a PRU can do is generate a simple signal starting with a single channel PWM that has a fixed frequency and duty cycle and ending with a multi channel PWM that the ARM can change the frequency and duty cycle on the fly.

5.3.1 Problem

I want to generate a PWM signal that has a fixed frequency and duty cycle.

5.3.2 Solution

The solution is fairly easy, but be sure to check the *Discussion* section for details on making it work.

`pwm1.pru0.c` shows the code.

Warning: This code is for the BeagleBone Black. See `pwm1.pru1_1.c` for an example that works on the AI.

Listing 5.3: `pwm1.pru0.c`

```

1 #include <stdint.h>
2 #include <pru_cfg.h>
3 #include "resource_table_empty.h"
4 #include "prugpio.h"
5
6 volatile register uint32_t __R30;
7 volatile register uint32_t __R31;
8
9 void main(void)
10 {
11     uint32_t gpio = P9_31;          // Select which pin to toggle.;
12
13     /* Clear SYSCFG[STANDBY_INIT] to enable OCP master port */
14     CT_CFG.SYSCFG_bit.STANDBY_INIT = 0;
15
16     while(1) {
17         __R30 |= gpio;              // Set the GPIO pin to 1
18         __delay_cycles(100000000);
19         __R30 &= ~gpio;            // Clear the GPIO pin
20         __delay_cycles(100000000);
21     }
22 }
```

`pwm1.pru0.c`

To run this code you need to configure the pin muxes to output the PRU. If you are on the Black run

```
bone$ config-pin P9_31 pruout
```

On the Pocket run

```
bone$ config-pin P1_36 pruout
```

Note: See [Configuring pins on the AI via device trees](#) for configuring pins on the AI.

Then, tell Makefile which PRU you are compiling for and what your target file is

```
bone$ export TARGET=pwm1.pru0
```

Now you are ready to compile

```

bone$ make
/opt/source/pru-cookbook-code/common/Makefile:29: MODEL=TI_AM335x_BeagleBone_
↪Black, TARGET=pwm1.pru0
- Stopping PRU 0
- copying firmware file /tmp/vsx-examples/pwm1.pru0.out to /lib/firmware/
↪am335x-pru0-fw
write_init_pins.sh
```

(continues on next page)

(continued from previous page)

```

- Starting PRU 0
MODEL    = TI_AM335x_BeagleBone_Black
PROC     = pru
PRUN     = 0
PRU_DIR  = /sys/class/remoteproc/remoteproc1

```

Now attach an LED (or oscilloscope) to P9_31 on the Black or P1.36 on the Pocket. You should see a squarewave.

5.3.3 Discussion

Since this is our first example we'll discuss the many parts in detail.

Listing 5.4: pwm1.pru0.c

```

1  #include <stdint.h>
2  #include <pru_cfg.h>
3  #include "resource_table_empty.h"
4  #include "prugpio.h"
5
6  volatile register uint32_t __R30;
7  volatile register uint32_t __R31;
8
9  void main(void)
10 {
11     uint32_t gpio = P9_31;           // Select which pin to toggle.;
12
13     /* Clear SYSCFG[STANDBY_INIT] to enable OCP master port */
14     CT_CFG.SYSCFG_bit.STANDBY_INIT = 0;
15
16     while(1) {
17         __R30 |= gpio;               // Set the GPIO pin to 1
18         __delay_cycles(100000000);
19         __R30 &= ~gpio;             // Clear the GPIO pin
20         __delay_cycles(100000000);
21     }
22 }

```

pwm1.pru0.c

[Line-by-line of pwm1.pru0.c](#) is a line-by-line expansion of the c code.

Table 5.2: Line-by-line of pwm1.pru0.c

Line	Explanation
1	Standard c-header include
2	Include for the PRU. The compiler knows where to find this since the <i>Makefile</i> says to look for includes in <i>/usr/lib/ti/pru-software-support-package</i>
3	The file <i>resource_table_empty.h</i> is used by the PRU loader. Generally we'll use the same file, and don't need to modify it.
4	This include has addresses for the GPIO ports and some bit positions for some of the headers.

Here's what's in *resource_table_empty.h*

Listing 5.5: resource_table_empty.c

```

1  /*
2  * ===== resource_table_empty.h =====
3  *
4  * Define the resource table entries for all PRU cores. This will be
5  * incorporated into corresponding base images, and used by the remoteproc

```

(continues on next page)

(continued from previous page)

```

6  * on the host-side to allocated/reserve resources. Note the remoteproc
7  * driver requires that all PRU firmware be built with a resource table.
8  *
9  * This file contains an empty resource table. It can be used either as:
10 *
11 *     1) A template, or
12 *     2) As-is if a PRU application does not need to configure PRU_INTC
13 *        or interact with the rpmsg driver
14 *
15 */
16
17 #ifndef _RSC_TABLE_PRU_H_
18 #define _RSC_TABLE_PRU_H_
19
20 #include <stddef.h>
21 #include <rsc_types.h>
22
23 struct my_resource_table {
24     struct resource_table base;
25
26     uint32_t offset[1]; /* Should match 'num' in actual definition */
27 };
28
29 #pragma DATA_SECTION(pru_remoteproc_ResourceTable, ".resource_table")
30 #pragma RETAIN(pru_remoteproc_ResourceTable)
31 struct my_resource_table pru_remoteproc_ResourceTable = {
32     1,          /* we're the first version that implements this */
33     0,          /* number of entries in the table */
34     0, 0,      /* reserved, must be zero */
35     0,          /* offset[0] */
36 };
37
38 #endif /* _RSC_TABLE_PRU_H_ */

```

resource_table_empty.c

Table 5.3: Line-by-line (continued)

Line	Explanation
6-7	<code>__R30</code> and <code>__R31</code> are two variables that refer to the PRU output (<code>__R30</code>) and input (<code>__R31</code>) registers. When you write something to <code>__R30</code> it will show up on the corresponding output pins. When you read from <code>__R31</code> you read the data on the input pins. NOTE: Both names begin with two underscore's. Section 5.7.2 of the PRU Optimizing C/C++ Compiler, v2.2, User's Guide gives more details.
11	This line selects which GPIO pin to toggle. The table below shows which bits in <code>__R30</code> map to which pins
14	<code>CT_CFG.SYSCFG_bit.STANDBY_INIT</code> is set to 0 to enable the OCP master port. More details on this and thousands of other registers see the TI AM335x TRM. Section 4 is on the PRU and section 4.5 gives details for all the registers.

Bit 0 is the LSB.

Todo: fill in Blue

Table 5.4: Mapping bit positions to pin names

PRU	Bit	Black pin	Pocket pin
0	0	P9_31	P1.36
0	1	P9_29	P1.33
0	2	P9_30	P2.32
0	3	P9_28	P2.30
0	4	P9_42b	P1.31
0	5	P9_27	P2.34
0	6	P9_41b	P2.28
0	7	P9_25	P1.29
0	14	P8_12(out) P8_16(in)	P2.24
0	15	P8_11(out) P8_15(in)	P2.33
1	0	P8_45	
1	1	P8_46	
1	2	P8_43	
1	3	P8_44	
1	4	P8_41	
1	5	P8_42	
1	6	P8_39	
1	7	P8_40	
1	8	P8_27	P2.35
1	9	P8_29	P2.01
1	10	P8_28	P1.35
1	11	P8_30	P1.04
1	12	P8_21	
1	13	P8_20	
1	14		P1.32
1	15		P1.30
1	16	P9_26(in)	

Note: See [Configuring pins on the AI via device trees](#) for all the PRU pins on the AI.

Since we are running on PRU 0, and we're using `0x0001`, that is bit 0, we'll be toggling P9_31.

Table 5.5: Line-by-line (continued again)

Line	Explanation
17	Here is where the action is. This line reads <code>__R30</code> and then ORs it with <code>gpio</code> , setting the bits where there is a 1 in <code>gpio</code> and leaving the bits where there is a 0. Thus we are setting the bit we selected. Finally the new value is written back to <code>__R30</code> .
18	<code>__delay_cycles</code> is an ((intrinsic function)) that delays with number of cycles passed to it. Each cycle is 5ns, and we are delaying 100,000,000 cycles which is 500,000,000ns, or 0.5 seconds.
19	This is like line 17, but <code>~gpio</code> inverts all the bits in <code>gpio</code> so that where we had a 1, there is now a 0. This 0 is then ANDed with <code>__R30</code> setting the corresponding bit to 0. Thus we are clearing the bit we selected.

Tip: You can read more about intrinsics in section 5.11 of the ([PRU Optimizing C/C++ Compiler, v2.2, User's Guide](#).)

When you run this code and look at the output you will see something like the following figure.

Notice the on time (`+Width(1)`) is 500ms, just as we predicted. The off time is 498ms, which is only 2ms off from our prediction. The standard deviation is 0, or only 380as, which is $380 * 10^{-18}$!

You can see how fast the PRU can run by setting both of the `__delay_cycles` to 0. This results in the next figure.

Notice the period is 15ns which gives us a frequency of about 67MHz. At this high frequency the breadboard that I'm using distorts the waveform so it's no longer a squarewave. The **on** time is 5.3ns and the **off** time is 9.8ns. That means `__R30 |= gpio` took only one 5ns cycle and `__R30 &= ~gpio` also only took one cycle, but there is also an extra cycle needed for the loop. This means the compiler was able to implement the `while` loop in just three 5ns instructions! Not bad.

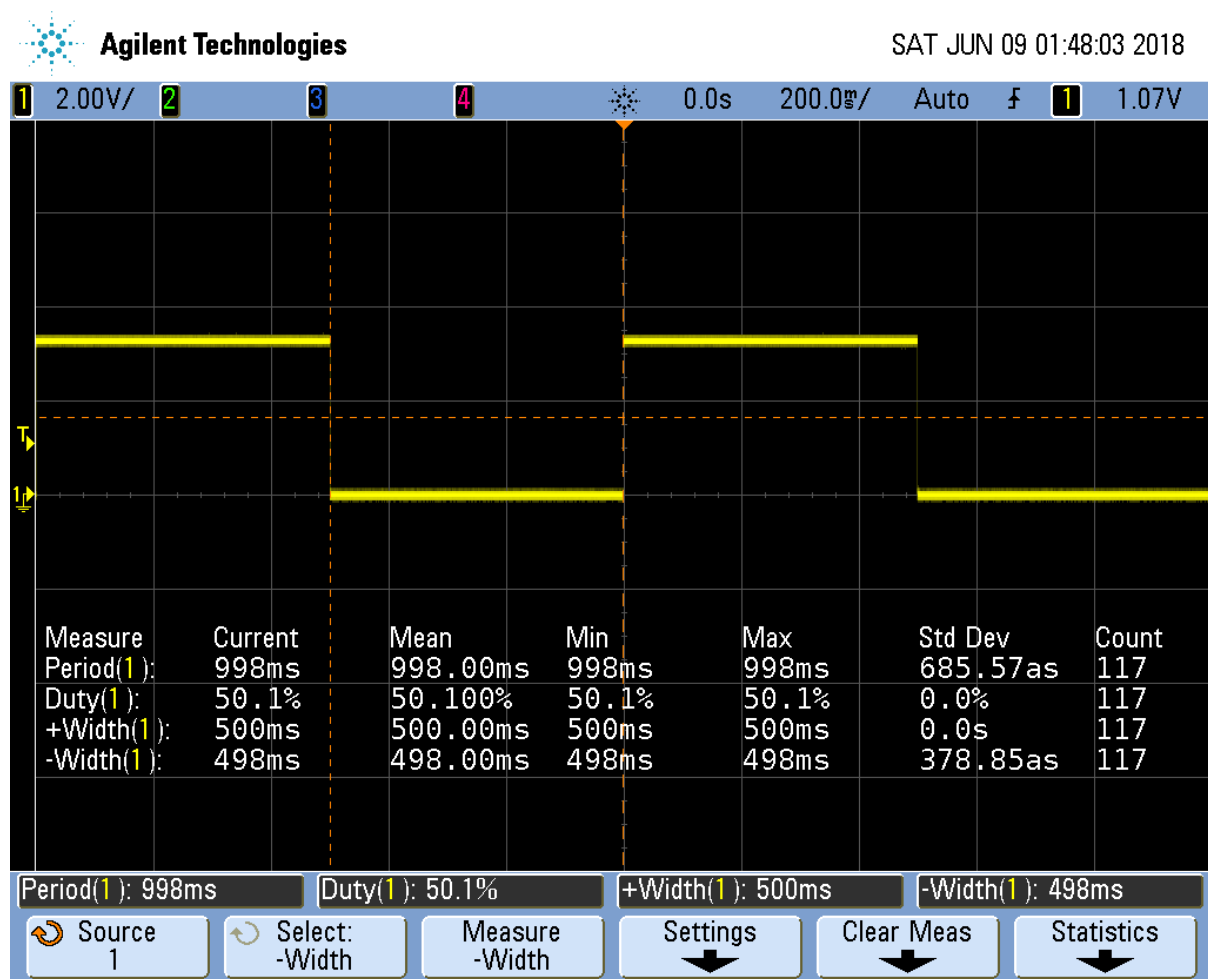

Fig. 5.2: Output of pwm1.pru0.c with 100,000,000 delays cycles giving a 1s period

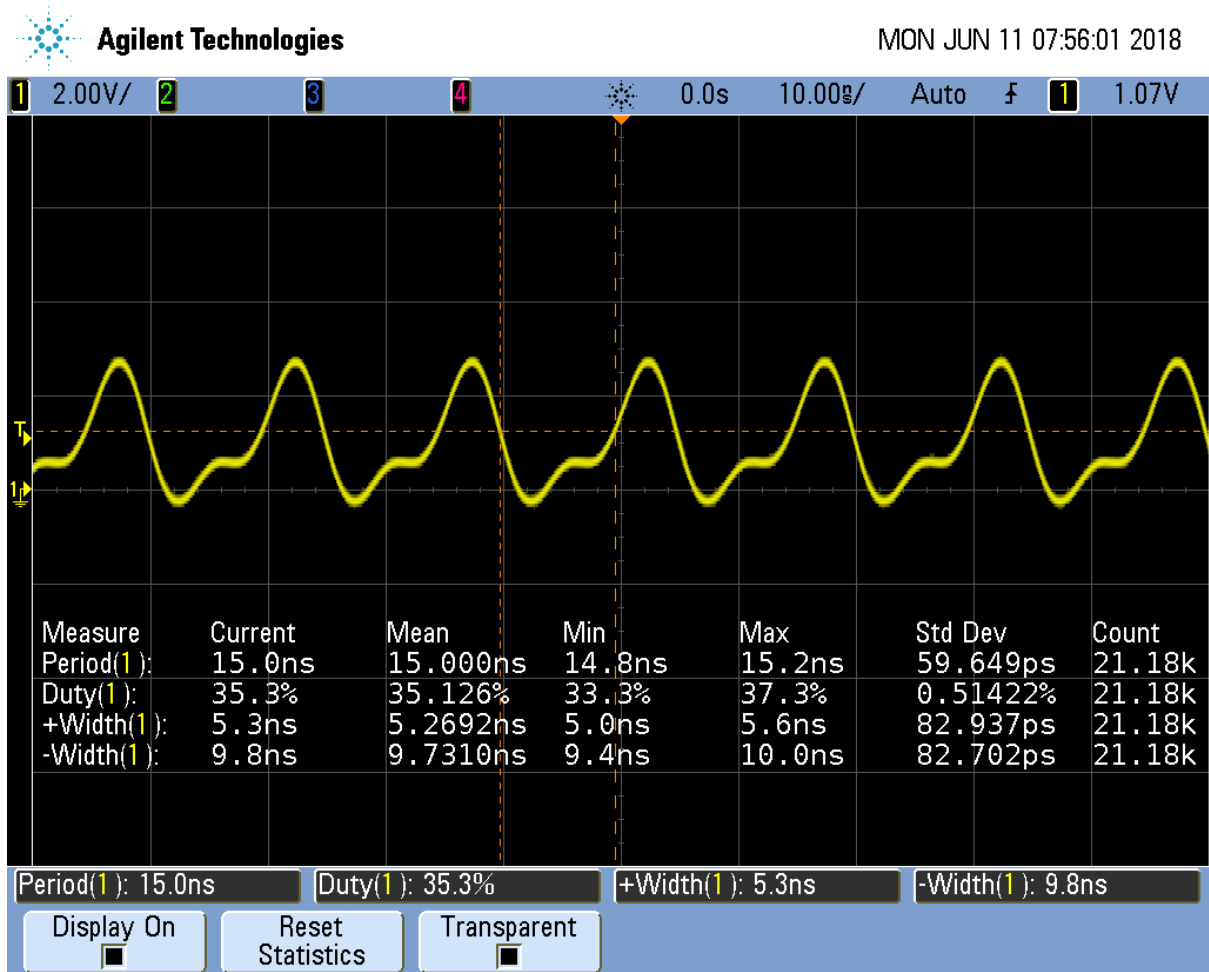

Fig. 5.3: Output of pwm1.pru0c with 0 delay cycles

We want a square wave, so we need to add a delay to correct for the delay of looping back.

Here's the code that does just that.

Listing 5.6: pwm2.pru0.c

```

1  #include <stdint.h>
2  #include <pru_cfg.h>
3  #include "resource_table_empty.h"
4  #include "prugpio.h"
5
6  volatile register uint32_t __R30;
7  volatile register uint32_t __R31;
8
9  void main(void)
10 {
11     uint32_t gpio = P9_31;           // Select which pin to toggle.;
12
13     /* Clear SYSCFG[STANDBY_INIT] to enable OCP master port */
14     CT_CFG.SYSCFG_bit.STANDBY_INIT = 0;
15
16     while (1) {
17         __R30 |= gpio;                // Set the GPIO pin to 1
18         __delay_cycles(1);           // Delay one cycle to correct for
↳loop time
19         __R30 &= ~gpio;              // Clear the GPIO pin
20         __delay_cycles(0);
21     }
22 }

```

pwm2.pru0.c

The output now looks like:

It's not hard to adjust the two `__delay_cycles` to get the desired frequency and duty cycle.

5.4 Controlling the PWM Frequency

5.4.1 Problem

You would like to control the frequency and duty cycle of the PWM without recompiling.

5.4.2 Solution

Have the PRU read the **on** and **off** times from a shared memory location. Each PRU has its own 8KB of data memory (DRAM) and 12KB of shared memory (SHAREDMEM) that the ARM processor can also access. See [PRU Block Diagram](#).

The DRAM 0 address is 0x0000 for PRU 0. The same DRAM appears at address 0x4A300000 as seen from the ARM processor.

Tip: See page 184 of the AM335x TRM (184).

We take the previous PRU code and add the lines

```

#define PRU0_DRAM           0x000000           // Offset to DRAM
volatile unsigned int *pru0_dram = PRU0_DRAM;

```

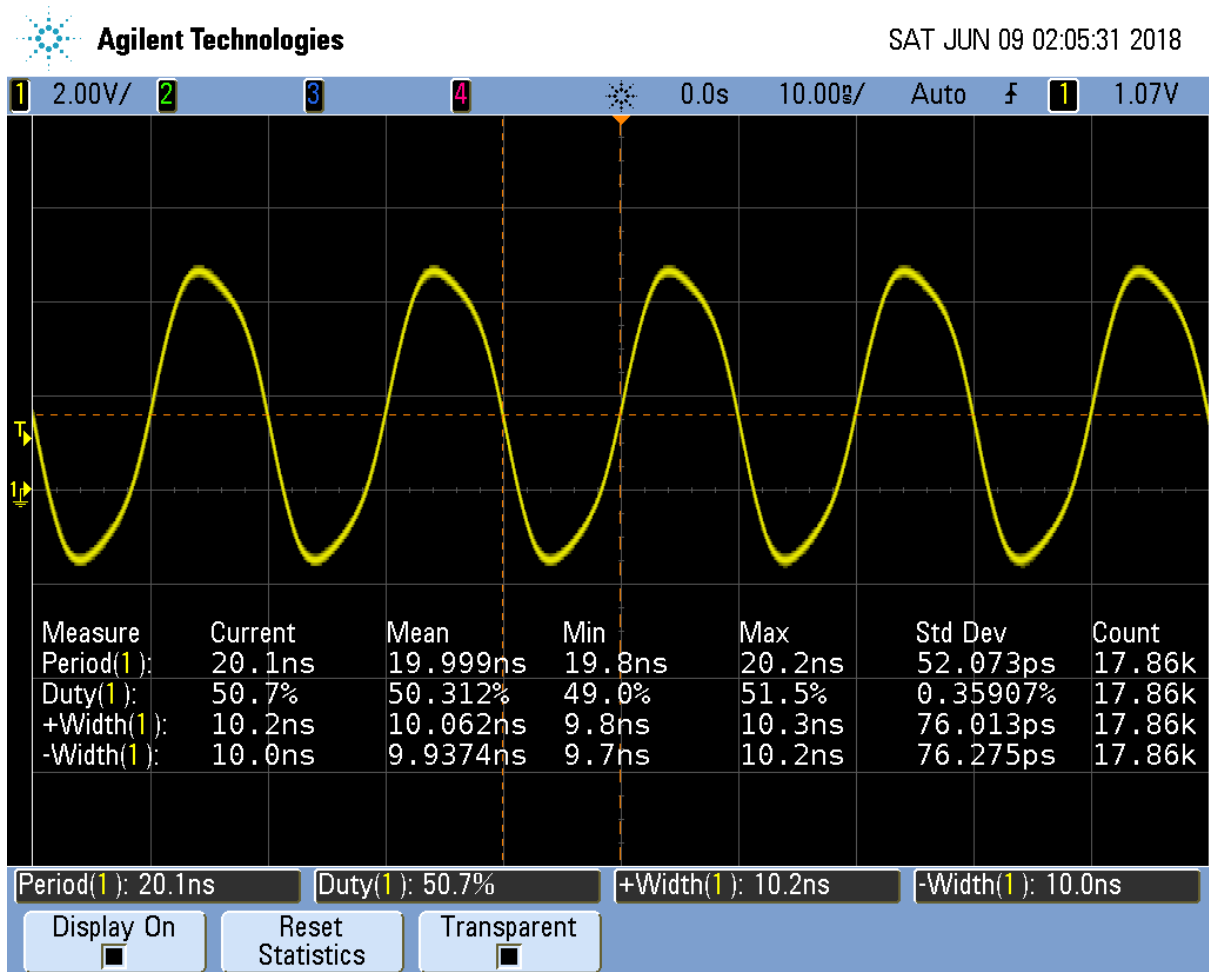

Fig. 5.4: Output of pwm2.pru0.c corrected delay

to define a pointer to the DRAM.

Note: The *volatile* keyword is used here to tell the compiler the value this points to may change, so don't make any assumptions while optimizing.

Later in the code we use

```
pru0_dram[ch] = on[ch];           // Copy to DRAM0 so the ARM can change it
pru0_dram[ch+MAXCH] = off[ch];  // Copy after the on array
```

to write the *on* and *off* times to the DRAM. Then inside the *while* loop we use

```
onCount[ch] = pru0_dram[2*ch];   // Read from DRAM0
offCount[ch]= pru0_dram[2*ch+1];
```

to read from the DRAM when resetting the counters. Now, while the PRU is running, the ARM can write values into the DRAM and change the PWM on and off times. [pwm4.pru0.c](#) is the whole code.

Listing 5.7: pwm4.pru0.c

```
1 // This code does MAXCH parallel PWM channels.
2 // It's period is 3 us
3 #include <stdint.h>
4 #include <pru_cfg.h>
5 #include "resource_table_empty.h"
6
7 #define PRU0_DRAM          0x00000          // Offset to
8   →DRAM
9 // Skip the first 0x200 byte of DRAM since the Makefile allocates
10 // 0x100 for the STACK and 0x100 for the HEAP.
11 volatile unsigned int *pru0_dram = (unsigned int *) (PRU0_DRAM + 0x200);
12
13 #define MAXCH              4              // Maximum number of channels per PRU
14
15 volatile register uint32_t __R30;
16 volatile register uint32_t __R31;
17
18 void main(void)
19 {
20     uint32_t ch;
21     uint32_t on[] = {1, 2, 3, 4};        // Number of cycles to stay on
22     uint32_t off[] = {4, 3, 2, 1};      // Number to stay off
23     uint32_t onCount[MAXCH];           // Current count
24     uint32_t offCount[MAXCH];
25
26     /* Clear SYSCFG[STANDBY_INIT] to enable OCP master port */
27     CT_CFG.SYSCFG_bit.STANDBY_INIT = 0;
28
29     // Initialize the channel counters.
30     for(ch=0; ch<MAXCH; ch++) {
31         pru0_dram[2*ch ] = on[ch];      // Copy to DRAM0
32         →so the ARM can change it
33         pru0_dram[2*ch+1] = off[ch];    // Interleave the on and
34         →off values
35         onCount[ch] = on[ch];
36         offCount[ch]= off[ch];
37     }
38     while (1) {
39         for(ch=0; ch<MAXCH; ch++) {
40             if(onCount[ch]) {
```

(continues on next page)

(continued from previous page)

```

39         onCount[ch]--;
40         __R30 |= 0x1<<ch;           // Set the
↳GPIO pin to 1
41     } else if(offCount[ch]) {
42         offCount[ch]--;
43         __R30 &= ~(0x1<<ch);     // Clear the
↳GPIO pin
44     } else {
45         onCount[ch] = pru0_dram[2*ch];
↳           // Read from DRAM0
46         offCount[ch]= pru0_dram[2*ch+1];
47     }
48 }
49 }
50 }

```

pwm4.pru0.c

Here is code that runs on the ARM side to set the on and off time values.

Listing 5.8: pwm-test.c

```

1  /*
2  *
3  *  pwm tester
4  *    The on cycle and off cycles are stored in each PRU's Data memory
5  *
6  */
7
8  #include <stdio.h>
9  #include <fcntl.h>
10 #include <sys/mman.h>
11
12 #define MAXCH 4
13
14 #define PRU_ADDR           0x4A300000           // Start of PRU
↳memory Page 184 am335x TRM
15 #define PRU_LEN           0x80000             //
↳Length of PRU memory
16 #define PRU0_DRAM        0x00000             // Offset to
↳DRAM
17 #define PRU1_DRAM        0x02000
18 #define PRU_SHAREDMEM    0x10000             // Offset to
↳shared memory
19
20 unsigned int      *pru0DRAM_32int_ptr;         // Points to the
↳start of local DRAM
21 unsigned int      *pru1DRAM_32int_ptr;         // Points to the
↳start of local DRAM
22 unsigned int      *prusharedMem_32int_ptr;     // Points to the start of
↳the shared memory
23
24 /
↳*****
25 * int start_pwm_count(int ch, int countOn, int countOff)
26 *
27 * Starts a pwm pulse on for countOn and off for countOff to a single channel
↳ (ch)
↳*****
28 *****
↳
29 int start_pwm_count(int ch, int countOn, int countOff) {
30     unsigned int *pruDRAM_32int_ptr = pru0DRAM_32int_ptr;

```

(continues on next page)

```

31     printf("countOn: %d, countOff: %d, count: %d\n",
32           countOn, countOff, countOn+countOff);
33     // write to PRU shared memory
34     pruDRAM_32int_ptr[2*(ch)+0] = countOn;           // On time
35     pruDRAM_32int_ptr[2*(ch)+1] = countOff;         // Off time
36     return 0;
37 }
38
39
40 int main(int argc, char *argv[])
41 {
42     unsigned int      *pru;                          // Points to start of PRU_
43     ↪memory.
44     int              fd;
45     printf("Servo tester\n");
46
47     fd = open ("/dev/mem", O_RDWR | O_SYNC);
48     if (fd == -1) {
49         printf ("ERROR: could not open /dev/mem.\n\n");
50         return 1;
51     }
52     pru = mmap (0, PRU_LEN, PROT_READ | PROT_WRITE, MAP_SHARED, fd, PRU_
53     ↪ADDR);
54     if (pru == MAP_FAILED) {
55         printf ("ERROR: could not map memory.\n\n");
56         return 1;
57     }
58     close(fd);
59     printf ("Using /dev/mem.\n");
60
61     pru0DRAM_32int_ptr =      pru + PRU0_DRAM/4 + 0x200/4;           // ↪
62     ↪Points to 0x200 of PRU0 memory
63     pru1DRAM_32int_ptr =      pru + PRU1_DRAM/4 + 0x200/4;           // ↪
64     ↪Points to 0x200 of PRU1 memory
65     prusharedMem_32int_ptr = pru + PRU_SHAREDMEM/4;                 // Points to ↪
66     ↪start of shared memory
67
68     int i;
69     for(i=0; i<MAXCH; i++) {
70         start_pwm_count(i, i+1, 20-(i+1));
71     }
72
73     if(munmap(pru, PRU_LEN)) {
74         printf("munmap failed\n");
75     } else {
76         printf("munmap succeeded\n");
77     }
78 }

```

pwm-test.c

A quick check on the 'scope shows [Four Channel PWM with ARM control](#).

From the 'scope you see a 1 cycle **on** time results in a 450ns wide pulse and a 3.06us period is 326KHz, much slower than the 10ns pulse we saw before. But it may be more than fast enough for many applications. For example, most servos run at 50Hz.

But we can do better.

5.5 Loop Unrolling for Better Performance

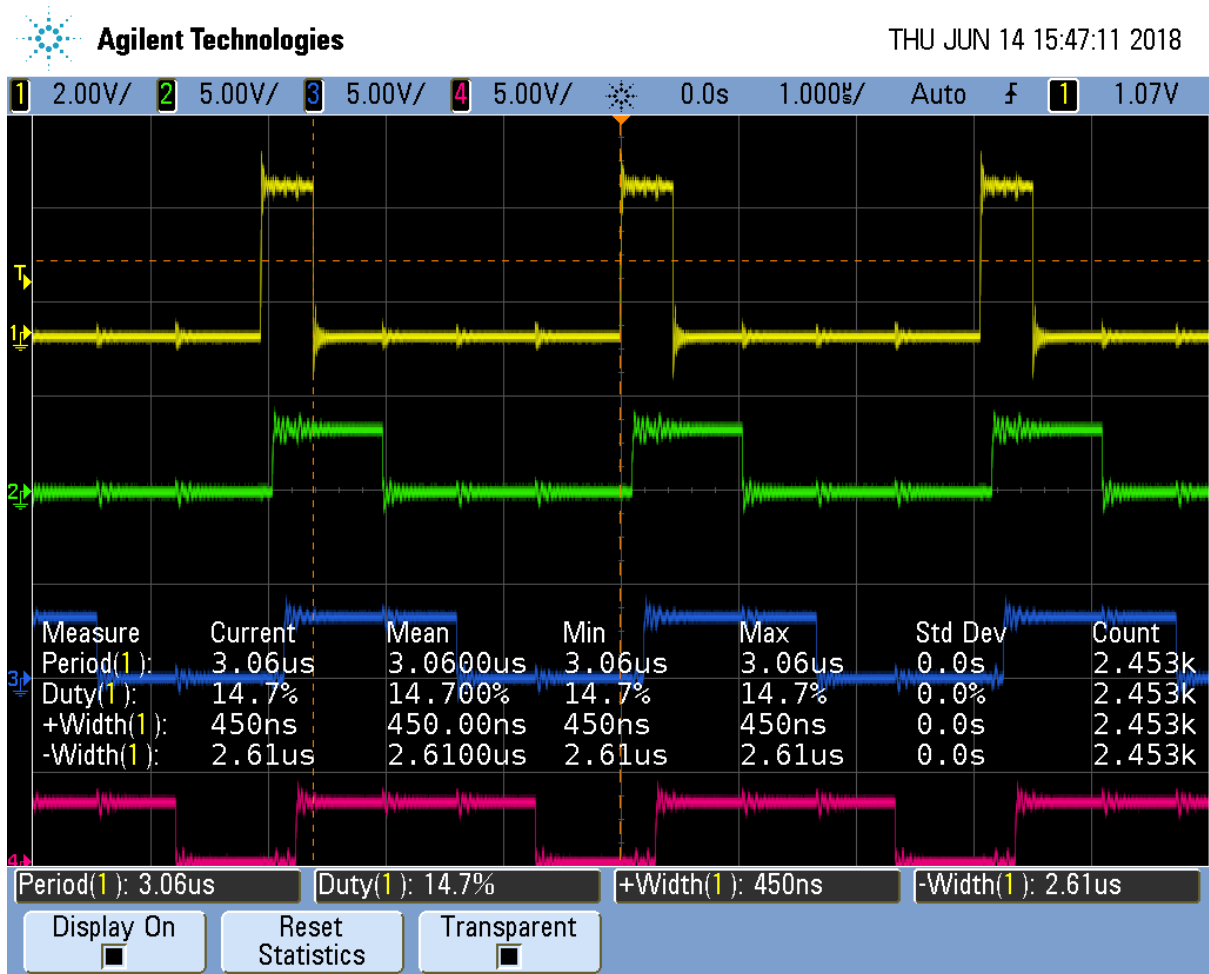

Fig. 5.5: Four Channel PWM with ARM control

5.5.1 Problem

The ARM controlled PRU code runs too slowly.

5.5.2 Solution

Simple loop unrolling can greatly improve the speed. `pwm5.pru0.c` is our unrolled version.

Listing 5.9: `pwm5.pru0.c` Unrolled

```

1 // This code does MAXCH parallel PWM channels.
2 // It's period is 510ns.
3 #include <stdint.h>
4 #include <pru_cfg.h>
5 #include "resource_table_empty.h"
6
7 #define PRU0_DRAM          0x00000          // Offset to
8   →DRAM
9 // Skip the first 0x200 byte of DRAM since the Makefile allocates
10 // 0x100 for the STACK and 0x100 for the HEAP.
11 volatile unsigned int *pru0_dram = (unsigned int *) (PRU0_DRAM + 0x200);
12
13 #define MAXCH          4          // Maximum number of channels per PRU
14
15 #define update(ch) \
16     if(onCount[ch]) {           \
17         onCount[ch]--;         \
18         __R30 |= 0x1<<ch;     \
19     } else if(offCount[ch]) {   \
20         offCount[ch]--;       \
21         __R30 &= ~(0x1<<ch);  \
22     } else {                   \
23         onCount[ch] = pru0_dram[2*ch]; \
24         offCount[ch]= pru0_dram[2*ch+1]; \
25     }
26
27 volatile register uint32_t __R30;
28 volatile register uint32_t __R31;
29
30 void main(void)
31 {
32     uint32_t ch;
33     uint32_t on[] = {1, 2, 3, 4};
34     uint32_t off[] = {4, 3, 2, 1};
35     uint32_t onCount[MAXCH], offCount[MAXCH];
36
37     /* Clear SYSCFG[STANDBY_INIT] to enable OCP master port */
38     CT_CFG.SYSCFG_bit.STANDBY_INIT = 0;
39
40 #pragma UNROLL(MAXCH)
41     for(ch=0; ch<MAXCH; ch++) {
42         pru0_dram[2*ch ] = on[ch];           // Copy to DRAM
43         →so the ARM can change it
44         pru0_dram[2*ch+1] = off[ch];        // Interleave the on and
45         →off values
46         onCount[ch] = on[ch];
47         offCount[ch]= off[ch];
48     }
49
50     while (1) {
51         update(0)

```

(continues on next page)

(continued from previous page)

```

49         update (1)
50         update (2)
51         update (3)
52     }
53 }

```

pwm5.pru0.c

The output of pwm5.pru0.c is in the figure below.

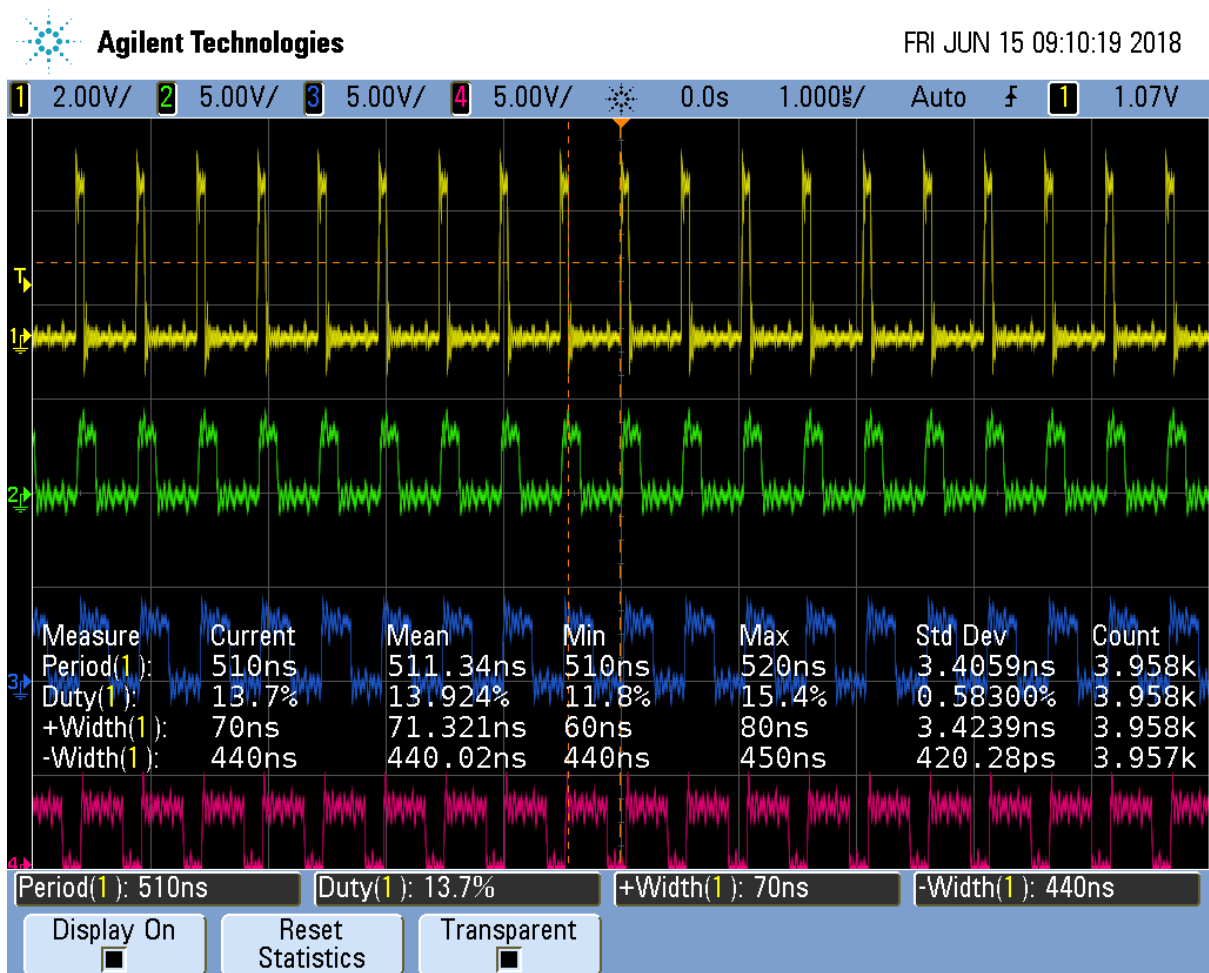

Fig. 5.6: pwm5.pru0.c Unrolled version of pwm4.pru0.c

It's running about 6 times faster than pwm4.pru0.c.

Table 5.6: pwm4.pru0.c vs. pwm5.pru0.c

Measure	pwm4.pru0.c time	pwm5.pru0.c time	Speedup	pwm5.pru0.c w/o UNROLL	Speedup
Period	3.06μs	510ns	6x	1.81μs	~1.7x
Width+	450ns	70ns	~6x	1.56μs	~.3x

Not a bad speed up for just a couple of simple changes.

5.5.3 Discussion

Here's how it works. First look at line 39. You see `#pragma UNROLL (MAXCH)` which is a `pragma` that tells the compiler to unroll the loop that follows. We are unrolling it `MAXCH` times (four times in this example). Just removing the `pragma` causes the speedup compared to the `pwm4.pru0.c` case to drop from 6x to only 1.7x.

We also have our `for` loop inside the `while` loop that can be unrolled. Unfortunately `UNROLL()` doesn't work on it, therefore we have to do it by hand. We could take the loop and just copy it three times, but that would make it harder to maintain the code. Instead I converted the loop into a `#define` (lines 14-24) and invoked `update()` as needed (lines 48-51). This is not a function call. Whenever the preprocessor sees the `update()` it copies the code and then it's compiled.

This unrolling gets us an impressive 6x speedup.

5.6 Making All the Pulses Start at the Same Time

5.6.1 Problem

I have a multichannel PWM working, but the pulses aren't synchronized, that is they don't all start at the same time.

5.6.2 Solution

[pwm5.pru0 Zoomed In](#) is a zoomed in version of the previous figure. Notice the pulse in each channel starts about 15ns later than the channel above it.

The solution is to declare `Rtmp` (line 35) which holds the value for `__R30`.

Listing 5.10: `pwm6.pru0.c` Sync'ed Version of `pwm5.pru0.c`

```

1 // This code does MAXCH parallel PWM channels.
2 // All channels start at the same time. It's period is 510ns
3 #include <stdint.h>
4 #include <pru_cfg.h>
5 #include "resource_table_empty.h"
6
7 #define PRU0_DRAM          0x00000          // Offset to_
   ↳DRAM
8 // Skip the first 0x200 byte of DRAM since the Makefile allocates
9 // 0x100 for the STACK and 0x100 for the HEAP.
10 volatile unsigned int *pru0_dram = (unsigned int *) (PRU0_DRAM + 0x200);
11
12 #define MAXCH            4          // Maximum number of channels per PRU
13
14 #define update(ch) \
15     if(onCount[ch]) {                \
16         onCount[ch]--;                \
17         Rtmp |= 0x1<<ch;              \
18     } else if(offCount[ch]) {        \
19         offCount[ch]--;              \
20         Rtmp &= ~(0x1<<ch);          \
21     } else {                          \
22         onCount[ch] = pru0_dram[2*ch]; \
23         offCount[ch] = pru0_dram[2*ch+1]; \
24     }
25
26 volatile register uint32_t __R30;
27 volatile register uint32_t __R31;

```

(continues on next page)

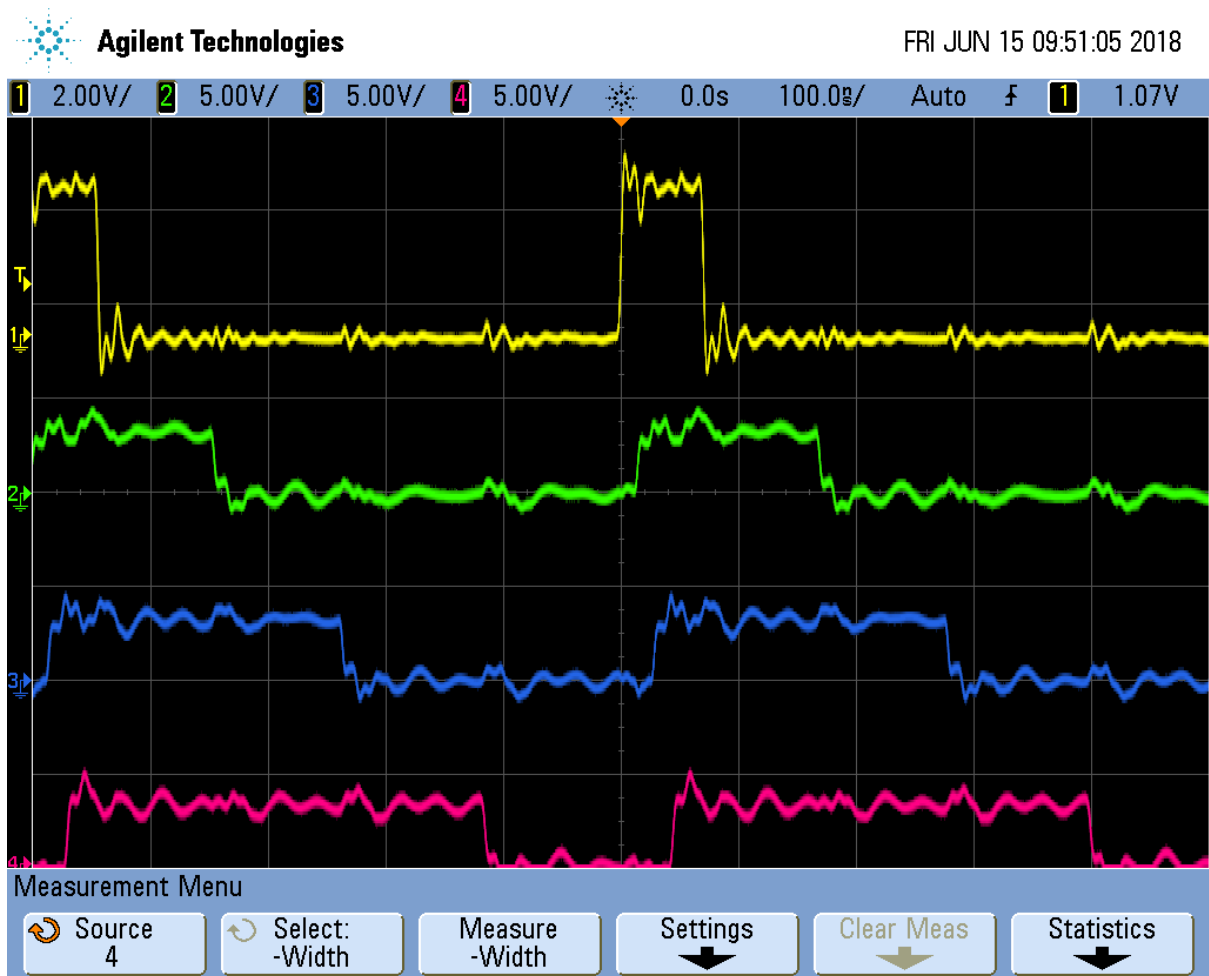

Fig. 5.7: pwm5.pru0 Zoomed In

```

28
29 void main(void)
30 {
31     uint32_t ch;
32     uint32_t on[] = {1, 2, 3, 4};
33     uint32_t off[] = {4, 3, 2, 1};
34     uint32_t onCount[MAXCH], offCount[MAXCH];
35     register uint32_t Rtmp;
36
37     /* Clear SYSCFG[STANDBY_INIT] to enable OCP master port */
38     CT_CFG.SYSCFG_bit.STANDBY_INIT = 0;
39
40     #pragma UNROLL(MAXCH)
41     for(ch=0; ch<MAXCH; ch++) {
42         pru0_dram[2*ch ] = on[ch];           // Copy to DRAM0
43         pru0_dram[2*ch+1] = off[ch];        // Interleave the on and
44         onCount[ch] = on[ch];              off values
45         offCount[ch]= off[ch];
46     }
47     Rtmp = __R30;
48
49     while (1) {
50         update(0)
51         update(1)
52         update(2)
53         update(3)
54         __R30 = Rtmp;
55     }
56 }

```

pwm6.pru0.c Sync'ed Version of pwm5.pru0.c

Each channel writes it's value to Rtmp (lines 17 and 20) and then after each channel has updated, Rtmp is copied to __R30 (line 54).

5.6.3 Discussion

The following figure shows the channel are sync'ed. Though the period is slightly longer than before.

5.7 Adding More Channels via PRU 1

5.7.1 Problem

You need more output channels, or you need to shorten the period.

5.7.2 Solution

PRU 0 can output up to eight output pins (see [Mapping bit positions to pin names](#)). The code presented so far can be easily extended to use the eight output pins.

But what if you need more channels? You can always use PRU1, it has 14 output pins.

Or, what if four channels is enough, but you need a shorter period. Everytime you add a channel, the overall period gets longer. Twice as many channels means twice as long a period. If you move half the channels to PRU 1, you will make the period half as long.

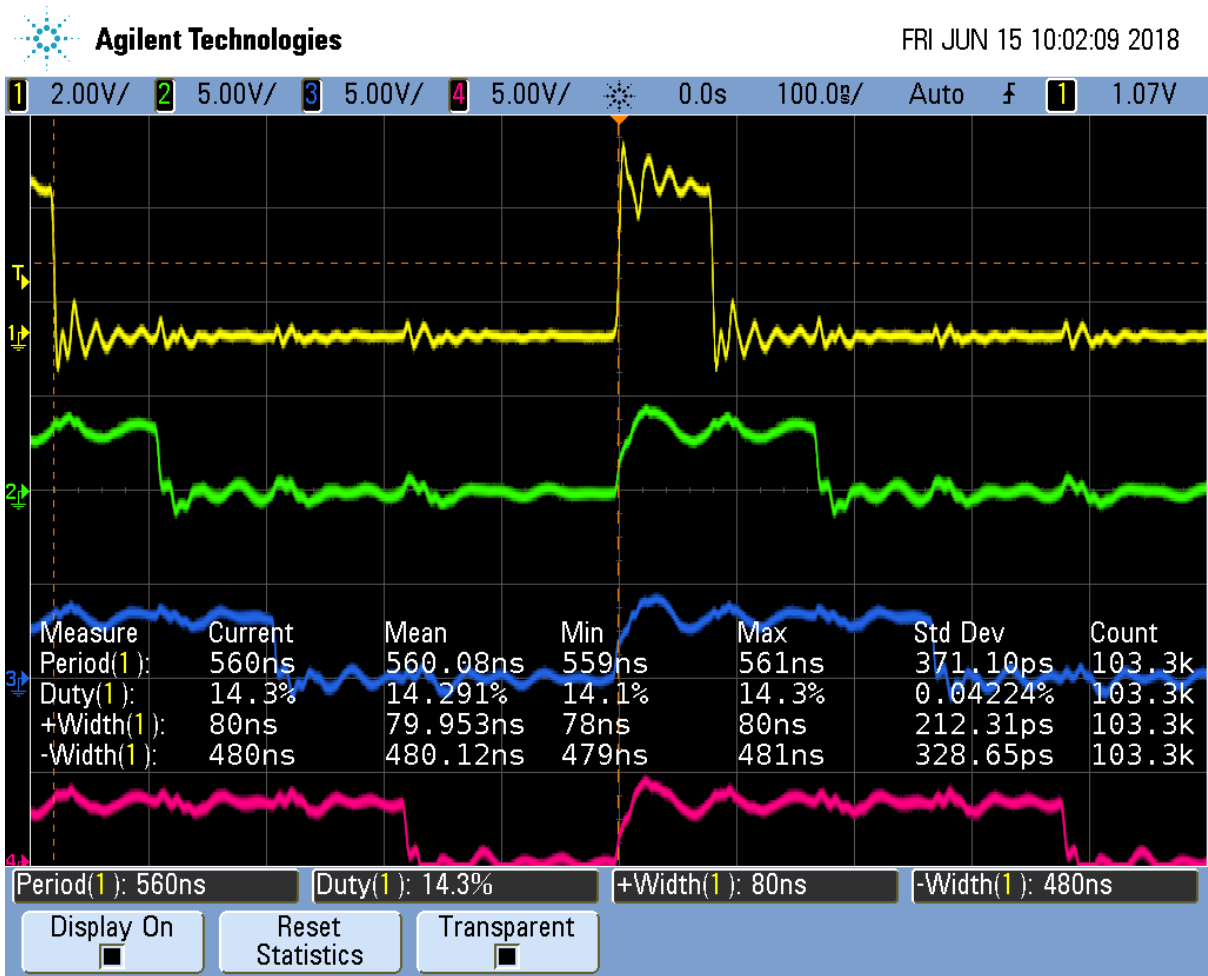

Fig. 5.8: pwm6.pru0 Synchronized Channels

Here's the code (pwm7.pru0.c)

Listing 5.11: pwm7.pru0.c Using Both PRUs

```

1 // This code does MAXCH parallel PWM channels on both PRU 0 and PRU 1
2 // All channels start at the same time. But the PRU 1 ch have a difference_
   ↳period
3 // It's period is 370ns
4 #include <stdint.h>
5 #include <pru_cfg.h>
6 #include "resource_table_empty.h"
7
8 #define PRUNUM 0
9
10 #define PRU0_DRAM           0x00000           // Offset to_
   ↳DRAM
11 // Skip the first 0x200 byte of DRAM since the Makefile allocates
12 // 0x100 for the STACK and 0x100 for the HEAP.
13 volatile unsigned int *pru0_dram = (unsigned int *) (PRU0_DRAM + 0x200);
14
15 #define MAXCH           2           // Maximum number of channels per PRU
16
17 #define update(ch) \
18         if(onCount[ch]) {           \
19             onCount[ch]--;           \
20             Rtmp |= 0x1<<ch;         \
21         } else if(offCount[ch]) {   \
22             offCount[ch]--;         \
23             Rtmp &= ~(0x1<<ch);     \
24         } else {                     \
25             onCount[ch] = pru0_dram[2*ch]; \
26             offCount[ch]= pru0_dram[2*ch+1]; \
27         }
28
29 volatile register uint32_t __R30;
30 volatile register uint32_t __R31;
31
32 void main(void)
33 {
34     uint32_t ch;
35     uint32_t on[] = {1, 2, 3, 4};
36     uint32_t off[] = {4, 3, 2, 1};
37     uint32_t onCount[MAXCH], offCount[MAXCH];
38     register uint32_t Rtmp;
39
40     /* Clear SYSCFG[STANDBY_INIT] to enable OCP master port */
41     CT_CFG.SYSCFG_bit.STANDBY_INIT = 0;
42
43 #pragma UNROLL (MAXCH)
44     for(ch=0; ch<MAXCH; ch++) {
45         pru0_dram[2*ch ] = on [ch+PRUNUM*MAXCH];           // Copy to_
   ↳DRAM0 so the ARM can change it
46         pru0_dram[2*ch+1] = off[ch+PRUNUM*MAXCH];         //_
   ↳Interleave the on and off values
47         onCount[ch] = on [ch+PRUNUM*MAXCH];
48         offCount[ch]= off[ch+PRUNUM*MAXCH];
49     }
50     Rtmp = __R30;
51
52     while (1) {
53         update(0)
54         update(1)
55         __R30 = Rtmp;

```

(continues on next page)

(continued from previous page)

```

56     }
57 }

```

pwm7.pru0.c Using Both PRUs

Be sure to run `pwm7_setup.sh` to get the correct pins configured.

Listing 5.12: `pwm7_setup.sh`

```

1  #!/bin/bash
2  #
3  export TARGET=pwm7.pru0
4  echo TARGET=$TARGET
5
6  # Configure the PRU pins based on which Beagle is running
7  machine=$(awk '{print $NF}' /proc/device-tree/model)
8  echo -n $machine
9  if [ $machine = "Black" ]; then
10     echo " Found"
11     pins="P9_31 P9_29 P8_45 P8_46"
12 elif [ $machine = "Blue" ]; then
13     echo " Found"
14     pins=""
15 elif [ $machine = "PocketBeagle" ]; then
16     echo " Found"
17     pins="P1_36 P1_33"
18 else
19     echo " Not Found"
20     pins=""
21 fi
22
23 for pin in $pins
24 do
25     echo $pin
26     config-pin $pin prout
27     config-pin -q $pin
28 done

```

`pwm7_setup.sh`

This makes sure the PRU 1 pins are properly configured.

Here we have a second `pwm7` file. `pwm7.pru1.c` is identical to `pwm7.pru0.c` except `PRUNUM` is set to 1, instead of 0.

Compile and run the two files with:

```

bone$ *make TARGET=pwm7.pru0; make TARGET=pwm7.pru1*
/opt/source/pru-cookbook-code/common/Makefile:29: MODEL=TI_AM335x_BeagleBone_
↪Black,TARGET=pwm7.pru0
-   Stopping PRU 0
-   copying firmware file /tmp/vsx-examples/pwm7.pru0.out to /lib/firmware/
↪am335x-pru0-fw
write_init_pins.sh
-   Starting PRU 0
MODEL    = TI_AM335x_BeagleBone_Black
PROC     = pru
PRUN     = 0
PRU_DIR  = /sys/class/remoteproc/remoteproc1
/opt/source/pru-cookbook-code/common/Makefile:29: MODEL=TI_AM335x_BeagleBone_
↪Black,TARGET=pwm7.pru1
-   Stopping PRU 1
-   copying firmware file /tmp/vsx-examples/pwm7.pru1.out to /lib/firmware/

```

(continues on next page)

(continued from previous page)

```

↪am335x-pru1-fw
write_init_pins.sh
- Starting PRU 1
MODEL    = TI_AM335x_BeagleBone_Black
PROC     = pru
PRUN     = 1
PRU_DIR  = /sys/class/remoteproc/remoteproc2

```

This will first stop, compile and start PRU 0, then do the same for PRU 1.

Moving half of the channels to PRU1 dropped the period from 510ns to 370ns, so we gained a bit.

5.7.3 Discussion

There weren't many changes to be made. Line 15 we set MAXCH to 2. Lines 44-48 is where the big change is.

```

pru0_dram[2*ch  ] = on [ch+PRUNUN*MAXCH];           // Copy to DRAM0 so the ARM_
↪can change it
pru0_dram[2*ch+1] = off[ch+PRUNUN*MAXCH];          // Interleave the on and off_
↪values
onCount [ch] = on [ch+PRUNUN*MAXCH];
offCount [ch]= off [ch+PRUNUN*MAXCH];

```

If we are compiling for PRU 0, `on [ch+PRUNUN*MAXCH]` becomes `on [ch+0*2]` which is `on [ch]` which is what we had before. But now if we are on PRU 1 it becomes `on [ch+1*2]` which is `on [ch+2]`. That means we are picking up the second half of the `on` and `off` arrays. The first half goes to PRU 0, the second to PRU 1. So the same code can be used for both PRUs, but we get slightly different behavior.

Running the code you will see the next figure.

What's going on there, the first channels look fine, but the PRU 1 channels are blurred. To see what's happening, let's stop the oscilloscope.

The stopped display shows that the four channels are doing what we wanted, except The PRU 0 channels have a period of 370ns while the PRU 1 channels at 330ns. It appears the compiler has optimized the two PRUs slightly differently.

5.8 Synchronizing Two PRUs

5.8.1 Problem

I need to synchronize the two PRUs so they run together.

5.8.2 Solution

Use the Interrupt Controller (INTC). It allows one PRU to signal the other. Page 225 of the AM335x TRM 225 has details of how it works. Here's the code for PRU 0, which at the end of the `while` loop signals PRU 1 to `start(pwm8.pru0.c)`.

Listing 5.13: `pwm8.pru0.c` PRU 0 using INTC to send a signal to PRU 1

```

1 // This code does MAXCH parallel PWM channels on both PRU 0 and PRU 1
2 // All channels start at the same time.
3 // It's period is 430ns
4 #include <stdint.h>
5 #include <pru_cfg.h>
6 #include <pru_intc.h>

```

(continues on next page)

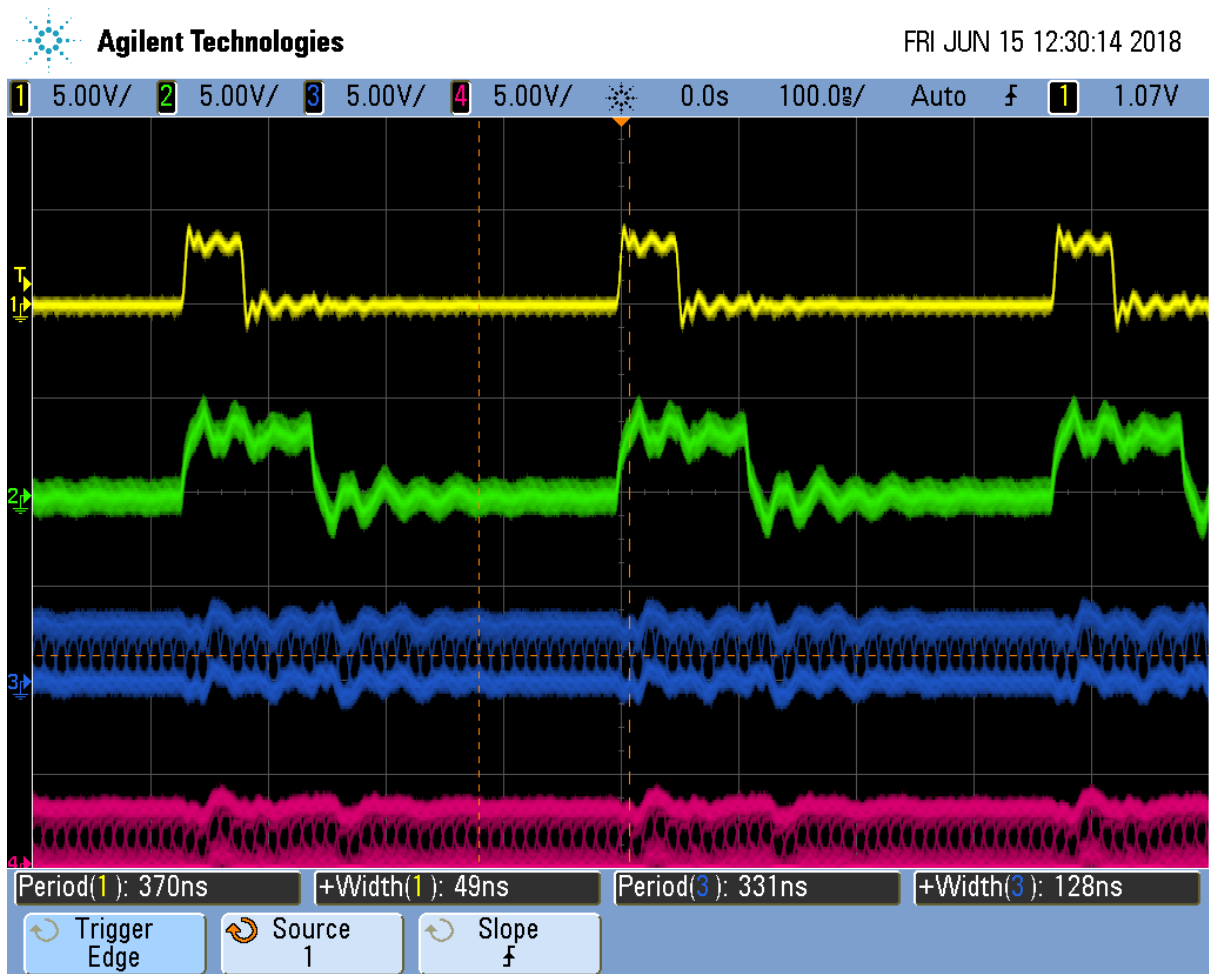

Fig. 5.9: pwm7.pru0 Two PRUs running

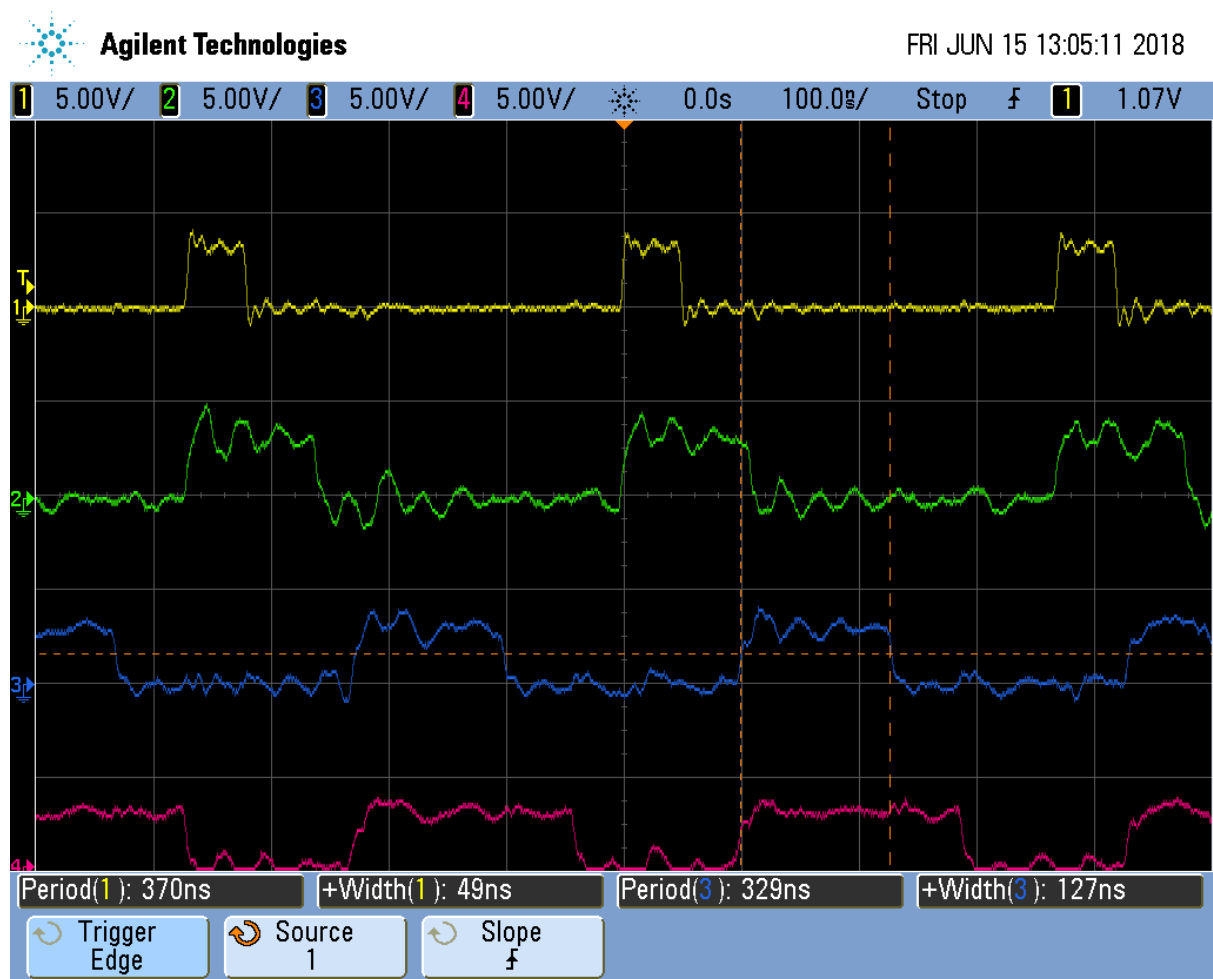

Fig. 5.10: pwm7.pru0 Two PRUs stopped

(continued from previous page)

```

7  #include <pru_ctrl.h>
8  #include "resource_table_empty.h"
9
10 #define PRUNUM 0
11
12 #define PRU0_DRAM          0x00000          // Offset to
   ↳DRAM
13 // Skip the first 0x200 byte of DRAM since the Makefile allocates
14 // 0x100 for the STACK and 0x100 for the HEAP.
15 volatile unsigned int *pru0_dram = (unsigned int *) (PRU0_DRAM + 0x200);
16
17 #define MAXCH          2          // Maximum number of channels per PRU
18
19 #define update(ch) \
20     if (onCount[ch]) {          \
21         onCount[ch]--;          \
22         Rtmp |= 0x1<<ch;        \
23     } else if (offCount[ch]) { \
24         offCount[ch]--;        \
25         Rtmp &= ~(0x1<<ch);    \
26     } else {                    \
27         onCount[ch] = pru0_dram[2*ch]; \
28         offCount[ch] = pru0_dram[2*ch+1]; \
29     }
30
31 volatile register uint32_t __R30;
32 volatile register uint32_t __R31;
33
34 // Initialize interrupts so the PRUs can be synchronized.
35 // PRU1 is started first and then waits for PRU0
36 // PRU0 is then started and tells PRU1 when to start going
37 void configIntc(void) {
38     __R31 = 0x00000000;          // Clear
   ↳any pending PRU-generated events
39     CT_INTC.CMR4_bit.CH_MAP_16 = 1;          // Map event 16 to
   ↳channel 1
40     CT_INTC.HMRO_bit.HINT_MAP_1 = 1;        // Map channel 1 to host 1
41     CT_INTC.SICR = 16;                  // Ensure
   ↳event 16 is cleared
42     CT_INTC.EISR = 16;                  // Enable
   ↳event 16
43     CT_INTC.HIEISR |= (1 << 0);          // Enable Host
   ↳interrupt 1
44     CT_INTC.GER = 1;                    // Globally
   ↳enable host interrupts
45 }
46
47 void main(void)
48 {
49     uint32_t ch;
50     uint32_t on[] = {1, 2, 3, 4};
51     uint32_t off[] = {4, 3, 2, 1};
52     uint32_t onCount[MAXCH], offCount[MAXCH];
53     register uint32_t Rtmp;
54
55     CT_CFG.GPCFG0 = 0x0000;              // Configure
   ↳GPI and GPO as Mode 0 (Direct Connect)
56     configIntc();                          //
   ↳Configure INTC
57
58     /* Clear SYSCFG[STANDBY_INIT] to enable OCP master port */

```

(continues on next page)

(continued from previous page)

```

59     CT_CFG.SYSCFG_bit.STANDBY_INIT = 0;
60
61     #pragma UNROLL(MAXCH)
62     for(ch=0; ch<MAXCH; ch++) {
63         pru0_dram[2*ch ] = on [ch+PRUNUM*MAXCH];           // Copy to
64         ↪DRAM0 so the ARM can change it
65         pru0_dram[2*ch+1] = off[ch+PRUNUM*MAXCH];         //
66         ↪Interleave the on and off values
67         onCount[ch] = on [ch+PRUNUM*MAXCH];
68         offCount[ch]= off[ch+PRUNUM*MAXCH];
69     }
70     Rtmp = __R30;
71
72     while (1) {
73         __R30 = Rtmp;
74         update(0)
75         update(1)
76 #define PRU0_PRU1_EVT 16
77         __R31 = (PRU0_PRU1_EVT-16) | (0x1<<5);           //Tell PRU 1
78         ↪to start
79         __delay_cycles(1);
80     }
81 }

```

pwm8.pru0.c PRU 0 using INTC to send a signal to PRU 1

PRU 2's code waits for PRU 0 before going.

Listing 5.14: pwm8.pru1.c PRU 1 waiting for INTC from PRU 0

```

1 // This code does MAXCH parallel PWM channels on both PRU 0 and PRU 1
2 // All channels start at the same time.
3 // It's period is 430ns
4 #include <stdint.h>
5 #include <pru_cfg.h>
6 #include <pru_intc.h>
7 #include <pru_ctrl.h>
8 #include "resource_table_empty.h"
9
10 #define PRUNUM 1
11
12 #define PRU0_DRAM           0x00000           // Offset to
13 ↪DRAM
14 // Skip the first 0x200 byte of DRAM since the Makefile allocates
15 // 0x100 for the STACK and 0x100 for the HEAP.
16 volatile unsigned int *pru0_dram = (unsigned int *) (PRU0_DRAM + 0x200);
17
18 #define MAXCH           2           // Maximum number of channels per PRU
19
20 #define update(ch) \
21     if(onCount[ch]) { \
22         onCount[ch]--; \
23         Rtmp |= 0x1<<ch; \
24     } else if(offCount[ch]) { \
25         offCount[ch]--; \
26         Rtmp &= ~(0x1<<ch); \
27     } else { \
28         onCount[ch] = pru0_dram[2*ch]; \
29         offCount[ch]= pru0_dram[2*ch+1]; \
30     }
31 volatile register uint32_t __R30;

```

(continues on next page)

(continued from previous page)

```

32 volatile register uint32_t __R31;
33
34 // Initialize interrupts so the PRUs can be synchronized.
35 // PRU1 is started first and then waits for PRU0
36 // PRU0 is then started and tells PRU1 when to start going
37
38 void main(void)
39 {
40     uint32_t ch;
41     uint32_t on[] = {1, 2, 3, 4};
42     uint32_t off[] = {4, 3, 2, 1};
43     uint32_t onCount[MAXCH], offCount[MAXCH];
44     register uint32_t Rtmp;
45
46     /* Clear SYSCFG[STANDBY_INIT] to enable OCP master port */
47     CT_CFG.SYSCFG_bit.STANDBY_INIT = 0;
48
49 #pragma UNROLL(MAXCH)
50     for(ch=0; ch<MAXCH; ch++) {
51         pruo_dram[2*ch ] = on [ch+PRUNUM*MAXCH];           // Copy to
52         ↪DRAM0 so the ARM can change it
53         pruo_dram[2*ch+1] = off[ch+PRUNUM*MAXCH];         //
54         ↪Interleave the on and off values
55         onCount[ch] = on [ch+PRUNUM*MAXCH];
56         offCount[ch]= off[ch+PRUNUM*MAXCH];
57     }
58     Rtmp = __R30;
59
60     while (1) {
61         while ((__R31 & (0x1<<31))==0) {                    // Wait for
62         ↪PRU 0
63         }
64         CT_INTC.SICR = 16;                                    //
65         ↪Clear event 16
66         __R30 = Rtmp;
67         update(0)
68         update(1)
69     }
70 }

```

pwm8.pru1.c PRU 1 waiting for INTC from PRU 0

In pwm8.pru0.c PRU 1 waits for a signal from PRU 0, so be sure to start PRU 1 first.

```
bone$ *make TARGET=pwm8.pru0; make TARGET=pwm8.pru1*
```

5.8.3 Discussion

The figure below shows the two PRUs are synchronized, though there is some extra overhead in the process so the period is longer.

This isn't much different from the previous examples.

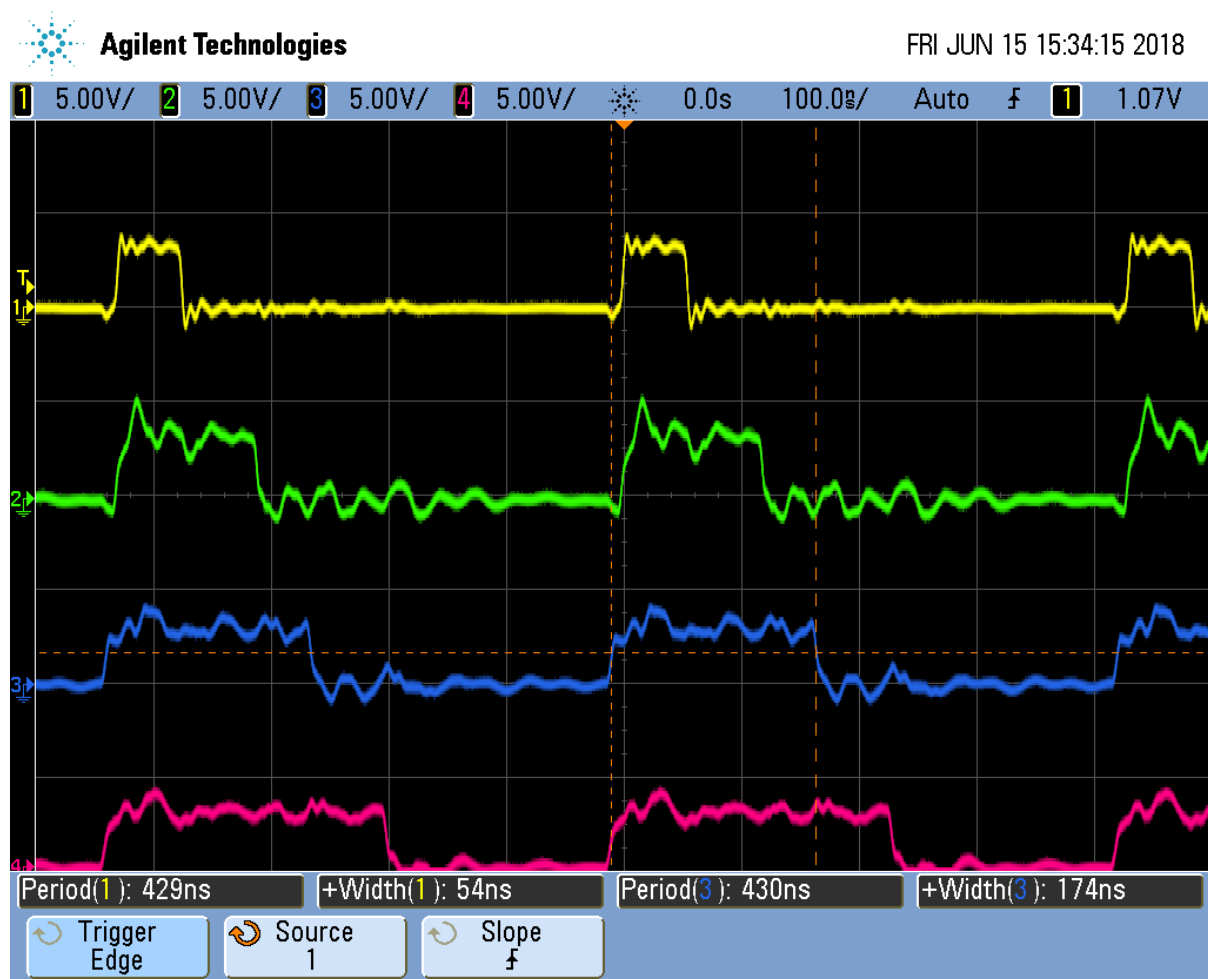

Fig. 5.11: pwm8.pru0 PRUs synced

Table 5.7: pwm8.pru0.c changes from pwm7.pru0.c

PRU	Line	Change
0	37-45	For PRU 0 these define <code>configInitc()</code> which initializes the interrupts. See page 226 of the AM335x TRM for a diagram explaining events, channels, hosts, etc.
0	55-56	Set a configuration register and call <code>configInitc</code> .
1	59-61	PRU 1 then waits for PRU 0 to signal it. Bit 31 of <code>___R31</code> corresponds to the Host-1 channel which <code>configInitc()</code> set up. We also clear event 16 so PRU 0 can set it again.
0	74-75	On PRU 0 this generates the interrupt to send to PRU 1. I found PRU 1 was slow to respond to the interrupt, so I put this code at the end of the loop to give time for the signal to get to PRU 1.

This ends the multipart pwm example.

5.9 Reading an Input at Regular Intervals

5.9.1 Problem

You have an input pin that needs to be read at regular intervals.

5.9.2 Solution

You can use the `___R31` register to read an input pin. Let's use the following pins.

Table 5.8: Input/Output pins

Direction	Bit number	Black	AI (ICSS2)	Pocket
out	0	P9_31	P8_44	P1_36
in	7	P9_25	P8_36	P1_29

These values came from [Mapping bit positions to pin names](#).

Configure the pins with `input_setup.sh`.

Listing 5.15: `input_setup.sh`

```

1  #!/bin/bash
2  #
3  export TARGET=input.pru0
4  echo TARGET=$TARGET
5
6  # Configure the PRU pins based on which Beagle is running
7  machine=$(awk '{print $NF}' /proc/device-tree/model)
8  echo -n $machine
9  if [ $machine = "Black" ]; then
10     echo " Found"
11     config-pin P9_31 pruout
12     config-pin -q P9_31
13     config-pin P9_25 pruin
14     config-pin -q P9_25
15 elif [ $machine = "Blue" ]; then
16     echo " Found"
17     pins=""
18 elif [ $machine = "PocketBeagle" ]; then
19     echo " Found"
20     config-pin P1_36 pruout
21     config-pin -q P1_36
22     config-pin P1_29 pruin

```

(continues on next page)

(continued from previous page)

```
23     config-pin -q P1_29
24 else
25     echo " Not Found"
26     pins=""
27 fi
```

input_setup.sh

The following code reads the input pin and writes its value to the output pin.

Listing 5.16: input.pru0.c

```
1 #include <stdint.h>
2 #include <pru_cfg.h>
3 #include "resource_table_empty.h"
4
5 volatile register uint32_t __R30;
6 volatile register uint32_t __R31;
7
8 void main(void)
9 {
10     uint32_t led;
11     uint32_t sw;
12
13     /* Clear SYSCFG[STANDBY_INIT] to enable OCP master port */
14     CT_CFG.SYSCFG_bit.STANDBY_INIT = 0;
15
16     led = 0x1<<0;           // P9_31 or P1_36
17     sw  = 0x1<<7;          // P9_25 or P1_29
18
19     while (1) {
20         if((__R31&sw) == sw) {
21             __R30 |= led;           // Turn on LED
22         } else
23             __R30 &= ~led;         // Turn off LED
24     }
25 }
26
```

input.pru0.c

5.9.3 Discussion

Just remember that __R30 is for outputs and __R31 is for inputs.

5.10 Analog Wave Generator

5.10.1 Problem

I want to generate an analog output, but only have GPIO pins.

5.10.2 Solution

The Beagle doesn't have a built-in analog to digital converter. You could get a [USB Audio Dongle](#) which are under \$10. But here we'll take another approach.

Earlier we generated a PWM signal. Here we'll generate a PWM whose duty cycle changes with time. A small duty cycle for when the output signal is small and a large duty cycle for when it is large.

This example was inspired by A PRU Sin Wave Generator in chapter 13 of Exploring BeagleBone by Derek Molloy.

Here's the code.

Listing 5.17: sine.pru0.c

```

1 // Generate an analog waveform and use a filter to reconstruct it.
2 #include <stdint.h>
3 #include <pru_cfg.h>
4 #include "resource_table_empty.h"
5 #include <math.h>
6
7 #define MAXT          100          // Maximum number of time samples
8 #define SAWTOOTH      // Pick which waveform
9
10 volatile register uint32_t __R30;
11 volatile register uint32_t __R31;
12
13 void main(void)
14 {
15     uint32_t onCount;           // Current count for 1 out
16     uint32_t offCount;         // count for 0 out
17     uint32_t i;
18     uint32_t waveform[MAXT]; // Waveform to be produced
19
20     // Generate a periodic wave in an array of MAXT values
21 #ifndef SAWTOOTH
22     for(i=0; i<MAXT; i++) {
23         waveform[i] = i*100/MAXT;
24     }
25 #endif
26 #ifdef TRIANGLE
27     for(i=0; i<MAXT/2; i++) {
28         waveform[i] = 2*i*100/MAXT;
29         waveform[MAXT-i-1] = 2*i*100/MAXT;
30     }
31 #endif
32 #ifdef SINE
33     float gain = 50.0f;
34     float bias = 50.0f;
35     float freq = 2.0f * 3.14159f / MAXT;
36     for (i=0; i<MAXT; i++){
37         waveform[i] = (uint32_t)(bias+gain*sin(i*freq));
38     }
39 #endif
40
41     /* Clear SYSCFG[STANDBY_INIT] to enable OCP master port */
42     CT_CFG.SYSCFG_bit.STANDBY_INIT = 0;
43
44     while (1) {
45         // Generate a PWM signal whose duty cycle matches
46         // the amplitude of the signal.
47         for(i=0; i<MAXT; i++) {
48             onCount = waveform[i];
49             offCount = 100 - onCount;
50             while(onCount-->0) {
51                 __R30 |= 0x1; // Set the GPIO_
52                 ↪pin to 1
53             }
54         }
55     }
56 }

```

(continues on next page)

(continued from previous page)

```
53         while (offCount--) {
54             __R30 &= ~(0x1);           // Clear the GPIO pin
55         }
56     }
57 }
58 }
```

sine.pru0.c

Set the `#define` at line 7 to the number of samples in one cycle of the waveform and set the `#define` at line 8 to which waveform and then run `make`.

5.10.3 Discussion

The code has two parts. The first part (lines 21 to 39) generate the waveform to be output. The `#define`'s let you select which waveform you want to generate. Since the output is a percent duty cycle, the values in `waveform[]` must be between 0 and 100 inclusive. The waveform is only generated once, so this part of the code isn't time critical.

The second part (lines 44 to 54) uses the generated data to set the duty cycle of the PWM on a cycle-by-cycle basis. This part is time critical; the faster we can output the values, the higher the frequency of the output signal.

Suppose you want to generate a sawtooth waveform like the one shown in [Continuous Sawtooth Waveform](#).

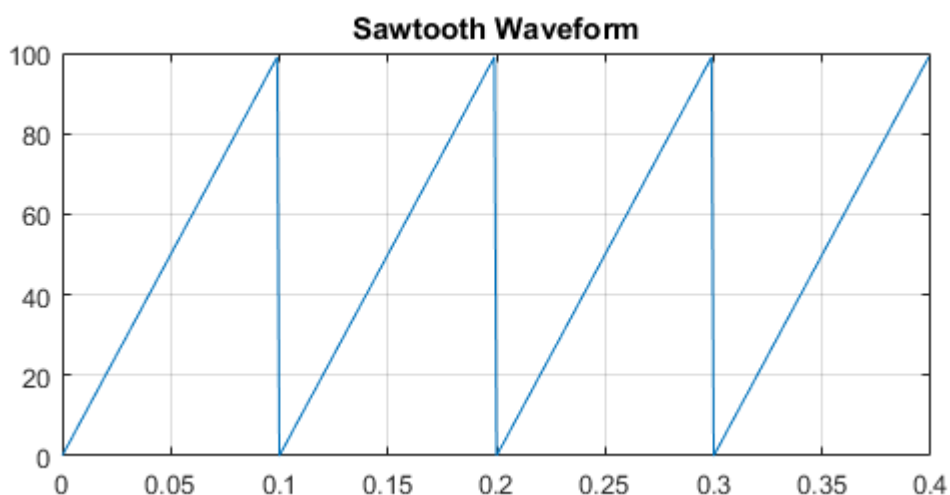

Fig. 5.12: Continuous Sawtooth Waveform

You need to sample the waveform and store one cycle. [Sampled Sawtooth Waveform](#) shows a sampled version of the sawtooth. You need to generate `MAXT` samples; here we show 20 samples, which may be enough. In the code `MAXT` is set to 100.

There's a lot going on here; let's take it line by line.

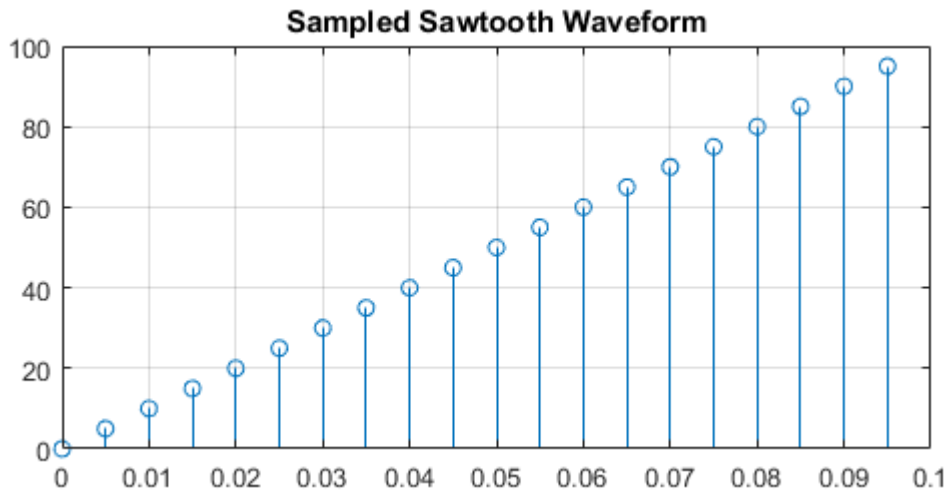

Fig. 5.13: Sampled Sawtooth Waveform

Table 5.9: Line-by-line of sine.pru0.c

Line	Explanation
2-5	Standard c-header includes
7	Number for samples in one cycle of the analog waveform
8	Which waveform to use. We've defined SAWTOOTH, TRIANGLE and SINE, but you can define your own too.
10-11	Declaring registers <code>pass : [__R30]</code> and <code>pass : [__R31]</code> .
15-16	<code>onCount</code> counts how many cycles the PWM should be 1 and <code>offCount</code> counts how many it should be off.
18	<code>waveform[]</code> stores the analog waveform being output.
21-24	SAWTOOTH is the simplest of the waveforms. Each sample is the duty cycle at that time and must therefore be between 0 and 100.
26-31	TRIANGLE is also a simple waveform.
32-39	SINE generates a sine wave and also introduces floating point. Yes, you can use floating point, but the PRUs don't have floating point hardware, rather, it's all done in software. This mean using floating point will make your code much bigger and slower. Slower doesn't matter in this part, and bigger isn't bigger than our instruction memory, so we're OK.
47	Here the <code>for</code> loop looks up each value of the generated waveform.
48,49	<code>onCount</code> is the number of cycles to be at 1 and <code>offCount</code> is the number of cycles to be 0. The two add to 100, one full cycle.
50-52	Stay on for <code>onCount</code> cycles.
53-55	Now turn off for <code>offCount</code> cycles, then loop back and look up the next cycle count.

Unfiltered Sawtooth Waveform shows the output of the code.

It doesn't look like a sawtooth; but if you look at the left side you will see each cycle has a longer and longer on time. The duty cycle is increasing. Once it's almost 100% duty cycle, it switches to a very small duty cycle. Therefore it's output what we programmed, but what we want is the average of the signal. The left hand side has a large (and increasing) average which would be for top of the sawtooth. The right hand side has a small average, which is what you want for the start of the sawtooth.

A simple low-pass filter, built with one resistor and one capacitor will do it. [Low-Pass Filter Wiring Diagram](#) shows how to wire it up.

Note: I used a 10K variable resistor and a 0.022uF capacitor. Probe the circuit between the resistor and the capacitor and adjust the resistor until you get a good looking waveform.

Reconstructed Sawtooth Waveform shows the results for filtered the SAWTOOTH.

Now that looks more like a sawtooth wave. The top plot is the time-domain plot of the output of the low-pass

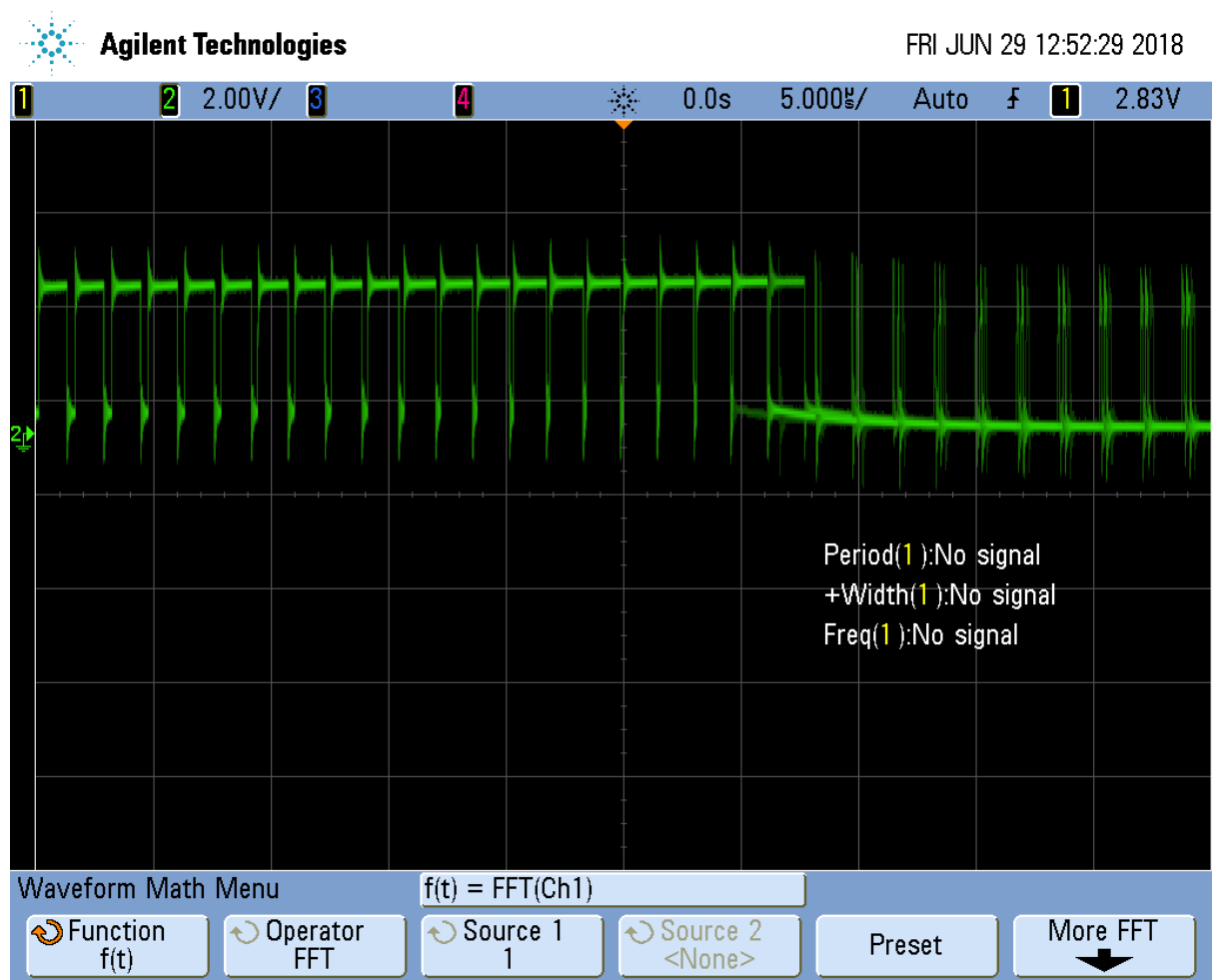

Fig. 5.14: Unfiltered Sawtooth Waveform

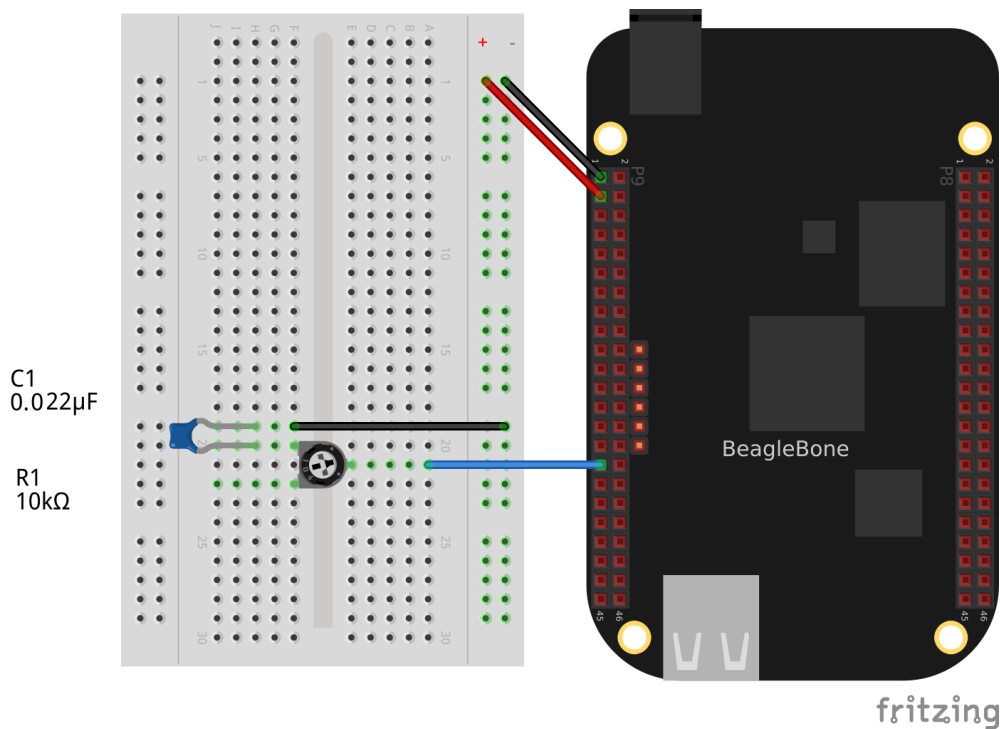

Fig. 5.15: Low-Pass Filter Wiring Diagram

filter. The bottom plot is the FFT of the top plot, therefore it's the frequency domain. We are getting a sawtooth with a frequency of about 6.1KHz. You can see the fundamental frequency on the bottom plot along with several harmonics.

The top looks like a sawtooth wave, but there is a high frequency superimposed on it. We are only using a simple first-order filter. You could lower the cutoff frequency by adjusting the resistor. You'll see something like [Reconstructed Sawtooth Waveform with Lower Cutoff Frequency](#).

The high frequencies have been reduced, but the corner of the waveform has been rounded. You can also adjust the cutoff to a higher frequency and you'll get a sharper corner, but you'll also get more high frequencies. See [Reconstructed Sawtooth Waveform with Higher Cutoff Frequency](#)

Adjust to taste, though the real solution is to build a higher order filter. Search for `_second order filter` and you'll find some nice circuits.

You can adjust the frequency of the signal by adjusting MAXT. A smaller MAXT will give a higher frequency. I've gotten good results with MAXT as small as 20.

You can also get a triangle waveform by setting the `#define`. [Reconstructed Triangle Waveform](#) shows the output signal.

And also the sine wave as shown in [Reconstructed Sinusoid Waveform](#).

Notice on the bottom plot the harmonics are much more suppressed.

Generating the sine waveform uses **floats**. This requires much more code. You can look in `/tmp/vsx-examples/sine.pru0.map` to see how much memory is being used. [/tmp/vsx-examples/sine.pru0.map for Sine Wave](#) shows the first few lines for the sine wave.

Listing 5.18: `/tmp/vsx-examples/sine.pru0.map` for Sine Wave

```

1 *****
2 PRU Linker Unix v2.1.5
3 *****
4 >> Linked Fri Jun 29 13:58:08 2018
5

```

(continues on next page)

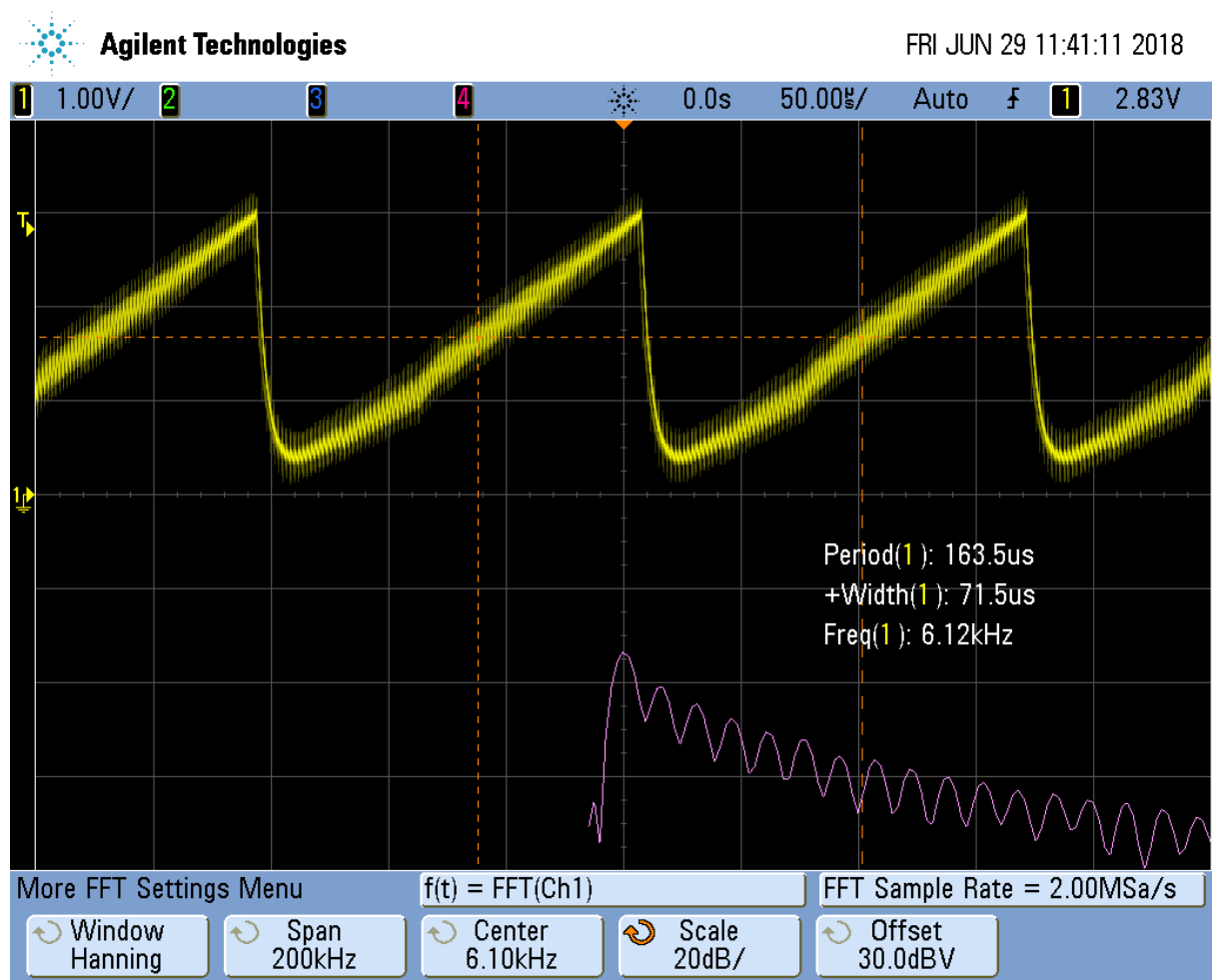

Fig. 5.16: Reconstructed Sawtooth Waveform

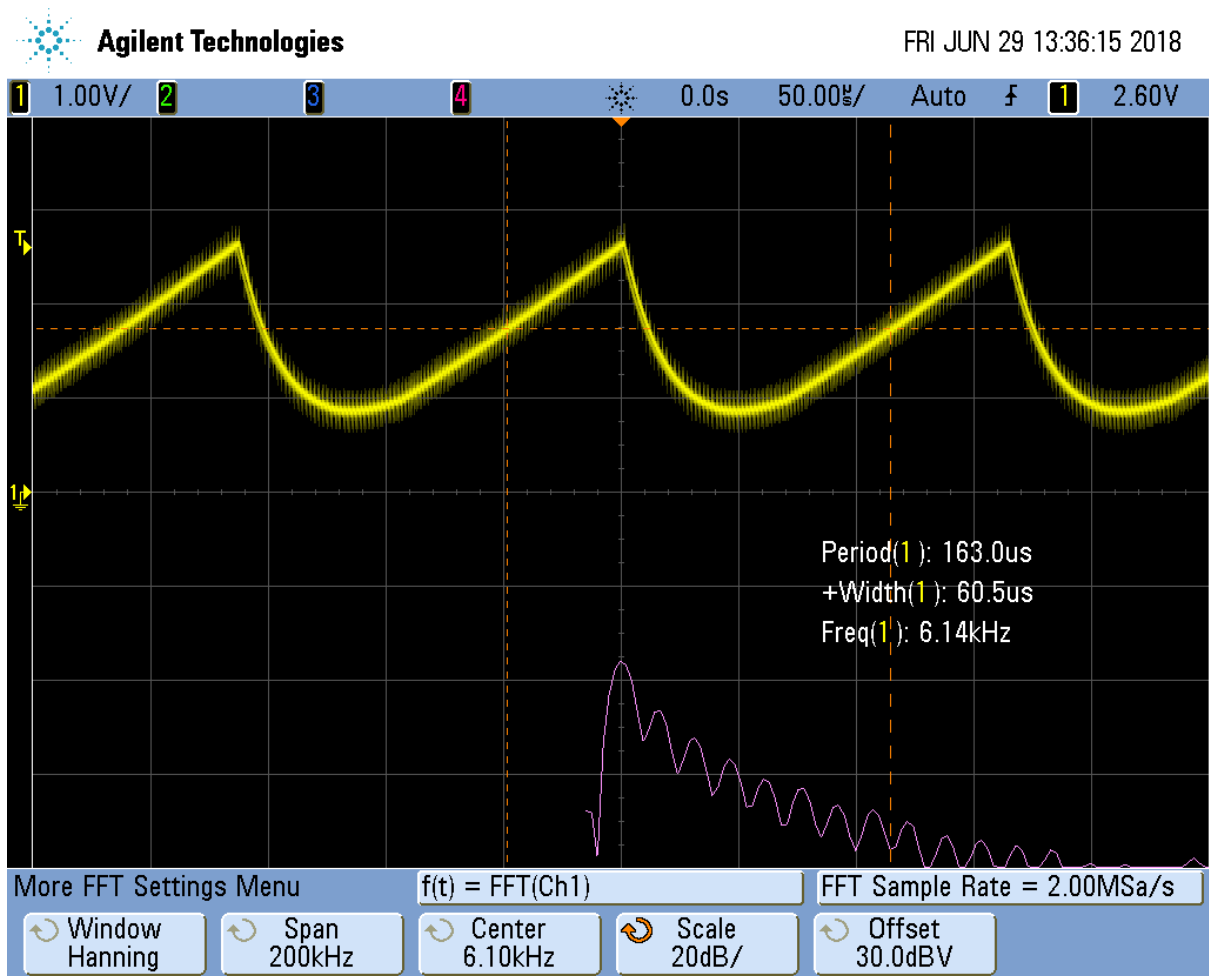

Fig. 5.17: Reconstructed Sawtooth Waveform with Lower Cutoff Frequency

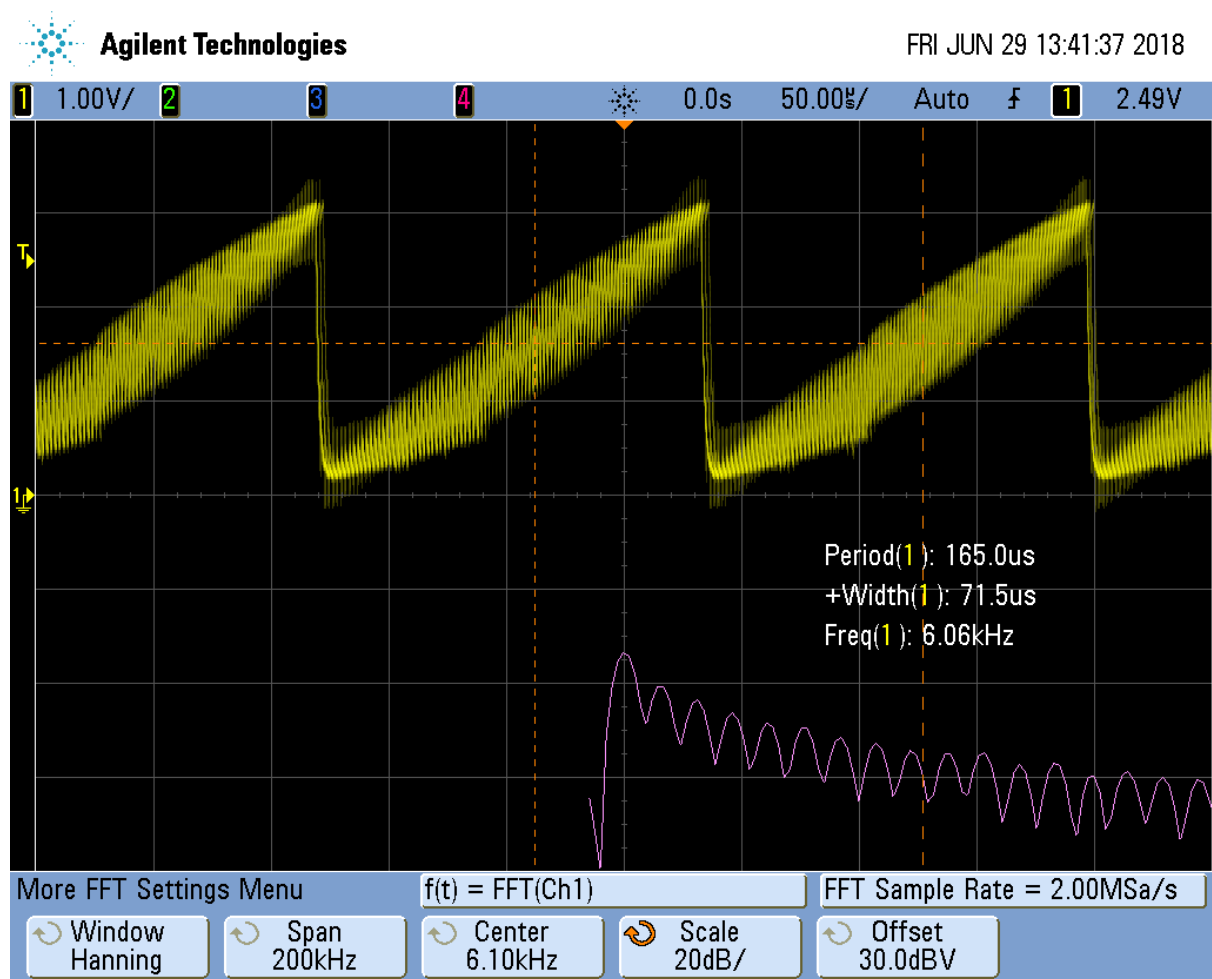

Fig. 5.18: Reconstructed Sawtooth Waveform with Higher Cutoff Frequency

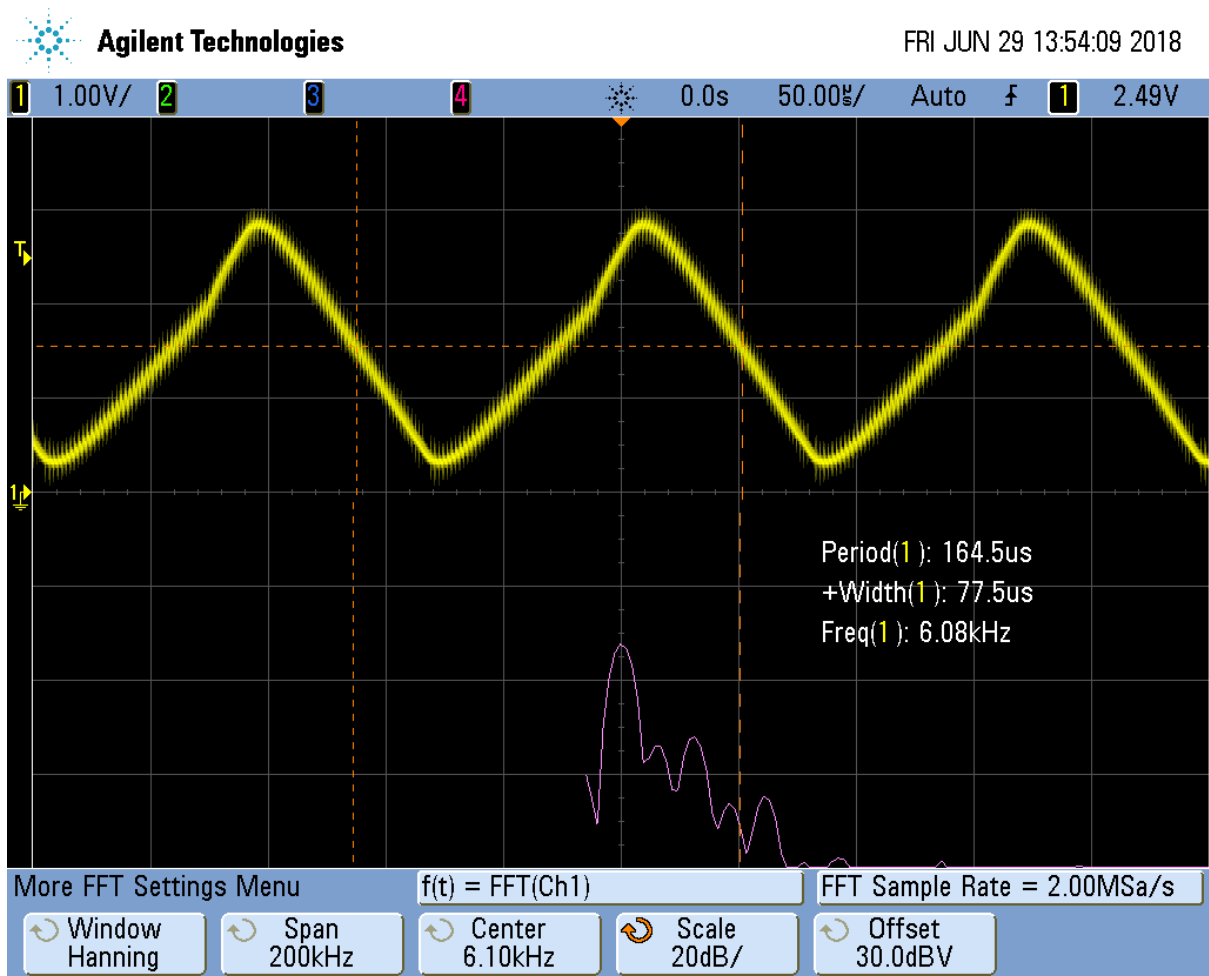

Fig. 5.19: Reconstructed Triangle Waveform

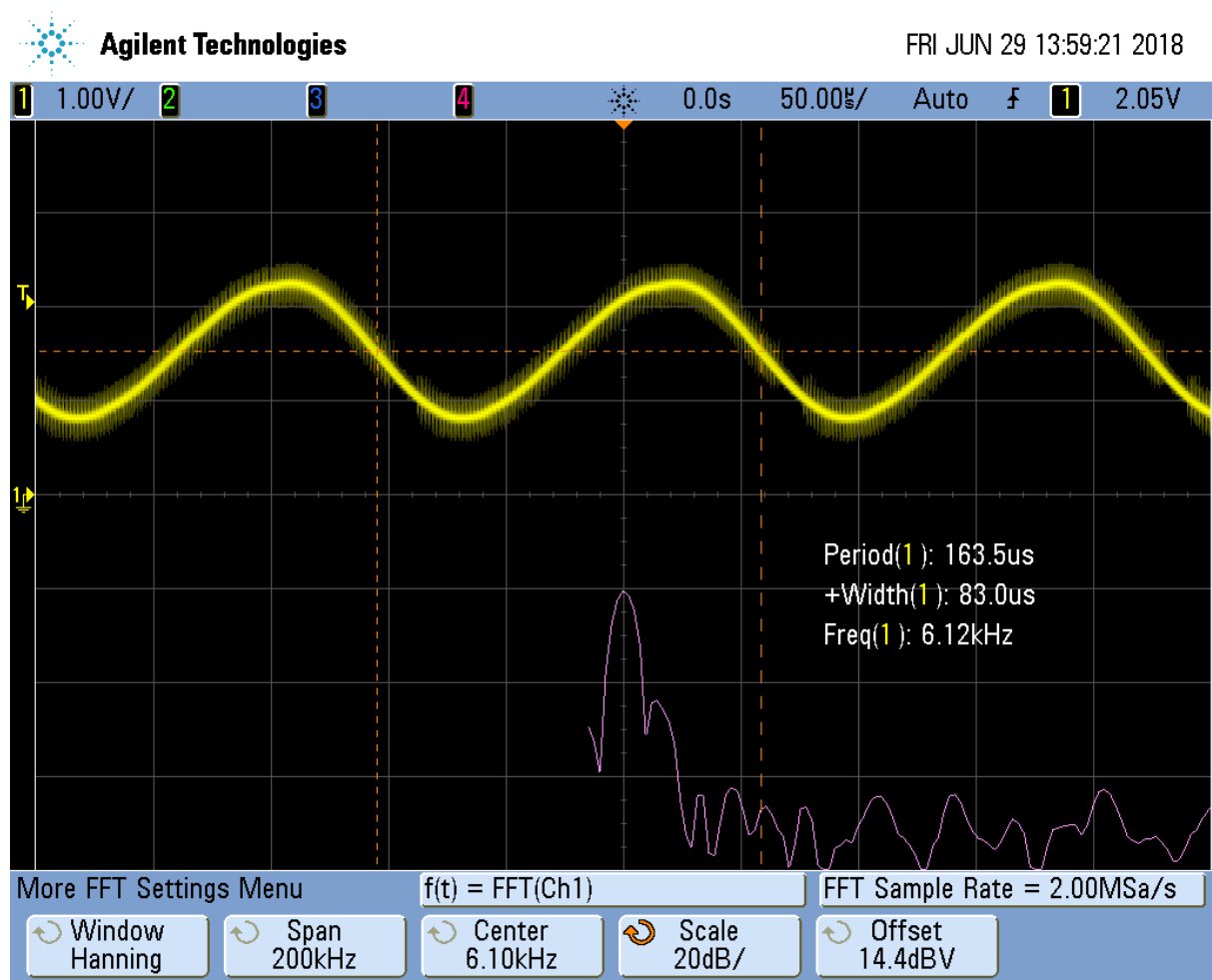

Fig. 5.20: Reconstructed Sinusoid Waveform

(continued from previous page)

```

6 OUTPUT FILE NAME: </tmp/pru0-gen/sine1.out>
7 ENTRY POINT SYMBOL: "_c_int00_noinit_noargs_noexit" address: 00000000
8
9
10 MEMORY CONFIGURATION
11
12      name              origin          length          used          unused          attr          fill
13 -----
14 ↪--
15 PAGE 0:
16   PRU_IMEM             00000000      00002000      000018c0      00000740      RWIX
17
18 PAGE 1:
19   PRU_DMEM_0_1        00000000      00002000      00000154      00001eac      RWIX
20   PRU_DMEM_1_0        00002000      00002000      00000000      00002000      RWIX
21
22 PAGE 2:
23   PRU_SHAREDMMEM      00010000      00003000      00000000      00003000      RWIX
24   PRU_INTC             00020000      00001504      00000000      00001504      RWIX
25   PRU_CFG              00026000      00000044      00000044      00000000      RWIX
26   PRU_UART             00028000      00000038      00000000      00000038      RWIX
27   PRU_IEP              0002e000      00000031c    00000000      00000031c    RWIX
28   PRU_ECAP             00030000      00000060      00000000      00000060      RWIX
29   RSVD27               00032000      00000100      00000000      00000100      RWIX
30   RSVD21               00032400      00000100      00000000      00000100      RWIX
31   L3OCMC               40000000      00010000      00000000      00010000      RWIX
32   MCASP0_DMA           46000000      00000100      00000000      00000100      RWIX
33   UART1                48022000      00000088      00000000      00000088      RWIX
34   UART2                48024000      00000088      00000000      00000088      RWIX
35   I2C1                 4802a000      000000d8      00000000      000000d8      RWIX
36   MCSPI0               48030000      000001a4      00000000      000001a4      RWIX
37   DMTIMER2             48040000      0000005c      00000000      0000005c      RWIX
38   MMCHS0               48060000      00000300      00000000      00000300      RWIX
39   MBX0                 480c8000      00000140      00000000      00000140      RWIX
40   SPINLOCK             480ca000      00000880      00000000      00000880      RWIX
41   I2C2                 4819c000      000000d8      00000000      000000d8      RWIX
42   MCSPI1               481a0000      000001a4      00000000      000001a4      RWIX
43   DCAN0                481cc000      000001e8      00000000      000001e8      RWIX
44   DCAN1                481d0000      000001e8      00000000      000001e8      RWIX
45   PWMSS0               48300000      000002c4      00000000      000002c4      RWIX
46   PWMSS1               48302000      000002c4      00000000      000002c4      RWIX
47   PWMSS2               48304000      000002c4      00000000      000002c4      RWIX
48   RSVD13               48310000      00000100      00000000      00000100      RWIX
49   RSVD10               48318000      00000100      00000000      00000100      RWIX
50   TPCC                 49000000      00001098      00000000      00001098      RWIX
51   GEMAC                4a100000      0000128c      00000000      0000128c      RWIX
52   DDR                  80000000      00000100      00000000      00000100      RWIX
53
54 SECTION ALLOCATION MAP
55
56      output              attributes/
57      section            page          origin          length          input sections
58 -----
59 .text:_c_int00*
60 *          0          00000000      00000014
61           00000000      00000014      rtspruv3_le.lib : boot_special.
62 ↪obj (.text:_c_int00_noinit_noargs_noexit)
63
64 .text          0          00000014      000018ac
65           00000014      00000374      rtspruv3_le.lib : sin.obj (.

```

(continues on next page)

(continued from previous page)

```

65 ↪text:sin)                00000388    00000314                : frcmpyd.obj (.
66 ↪text:__TI_frcmpyd)      0000069c    00000258                : frcadd.obj (.
67 ↪text:__TI_frcadd)      000008f4    00000254                : mpyd.obj (.
68 ↪text:__pruabi_mpyd)    00000b48    00000248                : addd.obj (.
69 ↪text:__pruabi_addd)    00000d90    000001c8                : mpyf.obj (.
70 ↪text:__pruabi_mpyf)    00000f58    00000100                : modf.obj (.
71 ↪text:modf)              00001058    000000b4                : gtd.obj (.text:_
72 ↪_pruabi_gtd)           0000110c    000000b0                : ged.obj (.text:_
73 ↪_pruabi_ged)           000011bc    000000b0                : ltd.obj (.text:_
74 ↪_pruabi_ltd)           0000126c    000000b0                sine1.obj (.text:main)
75 ↪_pruabi_ltd)           0000131c    000000a8                rtspruv3_le.lib : frcmpyf.obj (.
76 ↪text:__TI_frcmpyf)    000013c4    000000a0                : fixdu.obj (.
77 ↪text:__pruabi_fixdu)   00001464    0000009c                : round.obj (.
78 ↪text:__pruabi_nround)  00001500    00000090                : eqld.obj (.
79 ↪text:__pruabi_eqd)     00001590    0000008c                : renormd.obj (.
80 ↪text:__TI_renormd)    0000161c    0000008c                : fixdi.obj (.
81 ↪text:__pruabi_fixdi)   000016a8    00000084                : fltid.obj (.
82 ↪text:__pruabi_fltid)  0000172c    00000078                : cvtfd.obj (.
83 ↪text:__pruabi_cvtfd)  000017a4    00000050                : fltuf.obj (.
84 ↪text:__pruabi_asri)    000017f4    0000002c                : asri.obj (.
85 ↪text:__pruabi_subd)    00001820    0000002c                : subd.obj (.
86 ↪text:__pruabi_subd)    0000184c    00000024                : mpyi.obj (.
87 ↪text:__pruabi_mpyi)    00001870    00000020                : negd.obj (.
88 ↪text:__pruabi_negd)    00001890    00000020                : trunc.obj (.
89 ↪text:__pruabi_trunc)   000018b0    00000008                : exit.obj (.
90 ↪text:abort)           000018b8    00000008                : exit.obj (.
91 ↪text:loader_exit)     000018b8    00000008
92 .stack      1      00000000    00000100    UNINITIALIZED
93 ↪stack)      00000000    00000004    rtspruv3_le.lib : boot.obj (.
94 ↪stack)      00000004    000000fc    --HOLE--
95
96 .cinit      1      00000000    00000000    UNINITIALIZED
97
98 .fardata    1      00000100    00000040

```

(continues on next page)

(continued from previous page)

```

99          00000100    00000040    rtspruv3_le.lib : sin.obj (.
↳fardata:R$1)
100
101 .resource_table
102 *          1    00000140    00000014
103          00000140    00000014    sine1.obj (.resource_table:retain)
104
105 .creg.PRU_CFG.noload.near
106 *          2    00026000    00000044    NOLOAD SECTION
107          00026000    00000044    sine1.obj (.creg.PRU_CFG.noload.
↳near)
108
109 .creg.PRU_CFG.near
110 *          2    00026044    00000000    UNINITIALIZED
111
112 .creg.PRU_CFG.noload.far
113 *          2    00026044    00000000    NOLOAD SECTION
114
115 .creg.PRU_CFG.far
116 *          2    00026044    00000000    UNINITIALIZED
117
118
119 SEGMENT ATTRIBUTES
120
121      id tag      seg value
122      -- ---      - - - - -
123      0 PHA_PAGE 1    1
124      1 PHA_PAGE 2    1
125
126
127 GLOBAL SYMBOLS: SORTED ALPHABETICALLY BY Name
128
129 page  address    name
130 ----  -
131 0     000018b8    C$$EXIT
132 2     00026000    CT_CFG
133 abs  481cc000    __PRU_CREG_BASE_DCAN0
134 abs  481d0000    __PRU_CREG_BASE_DCAN1
135 abs  80000000    __PRU_CREG_BASE_DDR
136 abs  48040000    __PRU_CREG_BASE_DMTIMER2
137 abs  4a100000    __PRU_CREG_BASE_GEMAC
138 abs  4802a000    __PRU_CREG_BASE_I2C1
139 abs  4819c000    __PRU_CREG_BASE_I2C2
140 abs  40000000    __PRU_CREG_BASE_L3OCMC
141 abs  480c8000    __PRU_CREG_BASE_MBX0
142 abs  46000000    __PRU_CREG_BASE_MCASP0_DMA
143 abs  48030000    __PRU_CREG_BASE_MCSP10
144 abs  481a0000    __PRU_CREG_BASE_MCSP11
145 abs  48060000    __PRU_CREG_BASE_MMCHS0
146 abs  00026000    __PRU_CREG_BASE_PRU_CFG
147 abs  00000000    __PRU_CREG_BASE_PRU_DMEM_0_1
148 abs  00002000    __PRU_CREG_BASE_PRU_DMEM_1_0
149 abs  00030000    __PRU_CREG_BASE_PRU_ECAP
150 abs  0002e000    __PRU_CREG_BASE_PRU_IEP
151 abs  00020000    __PRU_CREG_BASE_PRU_INTC
152 abs  00010000    __PRU_CREG_BASE_PRU_SHAREDMMEM
153 abs  00028000    __PRU_CREG_BASE_PRU_UART
154 abs  48300000    __PRU_CREG_BASE_PWMSS0
155 abs  48302000    __PRU_CREG_BASE_PWMSS1
156 abs  48304000    __PRU_CREG_BASE_PWMSS2
157 abs  48318000    __PRU_CREG_BASE_RSVD10

```

(continues on next page)

(continued from previous page)

```

158 abs 48310000 __PRU_CREG_BASE_RSVD13
159 abs 00032400 __PRU_CREG_BASE_RSVD21
160 abs 00032000 __PRU_CREG_BASE_RSVD27
161 abs 480ca000 __PRU_CREG_BASE_SPINLOCK
162 abs 49000000 __PRU_CREG_BASE_TPCC
163 abs 48022000 __PRU_CREG_BASE_UART1
164 abs 48024000 __PRU_CREG_BASE_UART2
165 abs 0000000e __PRU_CREG_DCAN0
166 abs 0000000f __PRU_CREG_DCAN1
167 abs 0000001f __PRU_CREG_DDR
168 abs 00000001 __PRU_CREG_DMTIMER2
169 abs 00000009 __PRU_CREG_GEMAC
170 abs 00000002 __PRU_CREG_I2C1
171 abs 00000011 __PRU_CREG_I2C2
172 abs 0000001e __PRU_CREG_L30CMC
173 abs 00000016 __PRU_CREG_MBX0
174 abs 00000008 __PRU_CREG_MCASP0_DMA
175 abs 00000006 __PRU_CREG_MCSPI0
176 abs 00000010 __PRU_CREG_MCSPI1
177 abs 00000005 __PRU_CREG_MMCHS0
178 abs 00000004 __PRU_CREG_PRU_CFG
179 abs 00000018 __PRU_CREG_PRU_DMEM_0_1
180 abs 00000019 __PRU_CREG_PRU_DMEM_1_0
181 abs 00000003 __PRU_CREG_PRU_ECAP
182 abs 0000001a __PRU_CREG_PRU_IEP
183 abs 00000000 __PRU_CREG_PRU_INTC
184 abs 0000001c __PRU_CREG_PRU_SHAREDMMEM
185 abs 00000007 __PRU_CREG_PRU_UART
186 abs 00000012 __PRU_CREG_PWMSS0
187 abs 00000013 __PRU_CREG_PWMSS1
188 abs 00000014 __PRU_CREG_PWMSS2
189 abs 0000000a __PRU_CREG_RSVD10
190 abs 0000000d __PRU_CREG_RSVD13
191 abs 00000015 __PRU_CREG_RSVD21
192 abs 0000001b __PRU_CREG_RSVD27
193 abs 00000017 __PRU_CREG_SPINLOCK
194 abs 0000001d __PRU_CREG_TPCC
195 abs 0000000b __PRU_CREG_UART1
196 abs 0000000c __PRU_CREG_UART2
197 1 00000100 __TI_STACK_END
198 abs 00000100 __TI_STACK_SIZE
199 0 0000069c __TI_frcaddd
200 0 00000388 __TI_frcmpyd
201 0 0000131c __TI_frcmpyf
202 0 00001590 __TI_renormd
203 abs ffffffff __binit__
204 abs ffffffff __c_args__
205 0 00000b48 __pruabi_addd
206 0 000017f4 __pruabi_asri
207 0 0000172c __pruabi_cvtfd
208 0 00001500 __pruabi_eqd
209 0 0000161c __pruabi_fixdi
210 0 000013c4 __pruabi_fixdu
211 0 000016a8 __pruabi_fltid
212 0 000017a4 __pruabi_fltuf
213 0 0000110c __pruabi_ged
214 0 00001058 __pruabi_gtd
215 0 000011bc __pruabi_ltd
216 0 000008f4 __pruabi_mpyd
217 0 00000d90 __pruabi_mpyf
218 0 0000184c __pruabi_mpyi

```

(continues on next page)

(continued from previous page)

```

219 0 00001870 __pruabi_negd
220 0 00001464 __pruabi_nround
221 0 00001820 __pruabi_subd
222 0 00001890 __pruabi_trunc
223 0 00000000 _c_int00_noinit_noargs_noexit
224 1 00000000 _stack
225 0 000018b0 abort
226 abs ffffffff binit
227 0 0000126c main
228 0 00000f58 modf
229 1 00000140 pru_remoteproc_ResourceTable
230 0 00000014 sin

```

231

232

233 GLOBAL SYMBOLS: SORTED BY Symbol Address

234

```

235 page  address  name
236 ----  -
237 0 00000000 _c_int00_noinit_noargs_noexit
238 0 00000014 sin
239 0 00000388 __TI_frcmpyd
240 0 0000069c __TI_frcaddd
241 0 000008f4 __pruabi_mpyd
242 0 00000b48 __pruabi_addd
243 0 00000d90 __pruabi_mpyf
244 0 00000f58 modf
245 0 00001058 __pruabi_gtd
246 0 0000110c __pruabi_ged
247 0 000011bc __pruabi_ltd
248 0 0000126c main
249 0 0000131c __TI_frcmpyf
250 0 000013c4 __pruabi_fixdu
251 0 00001464 __pruabi_nround
252 0 00001500 __pruabi_eqd
253 0 00001590 __TI_renormd
254 0 0000161c __pruabi_fixdi
255 0 000016a8 __pruabi_fltid
256 0 0000172c __pruabi_cvtfd
257 0 000017a4 __pruabi_fltuf
258 0 000017f4 __pruabi_asri
259 0 00001820 __pruabi_subd
260 0 0000184c __pruabi_mpyi
261 0 00001870 __pruabi_negd
262 0 00001890 __pruabi_trunc
263 0 000018b0 abort
264 0 000018b8 C$$EXIT
265 1 00000000 _stack
266 1 00000100 __TI_STACK_END
267 1 00000140 pru_remoteproc_ResourceTable
268 2 00026000 CT_CFG
269 abs 00000000 __PRU_CREG_BASE_PRU_DMEM_0_1
270 abs 00000000 __PRU_CREG_PRU_INTC
271 abs 00000001 __PRU_CREG_DMTIMER2
272 abs 00000002 __PRU_CREG_I2C1
273 abs 00000003 __PRU_CREG_PRU_ECAP
274 abs 00000004 __PRU_CREG_PRU_CFG
275 abs 00000005 __PRU_CREG_MMCHS0
276 abs 00000006 __PRU_CREG_MCSPIO
277 abs 00000007 __PRU_CREG_PRU_UART
278 abs 00000008 __PRU_CREG_MCASPO_DMA
279 abs 00000009 __PRU_CREG_GEMAC

```

(continues on next page)

(continued from previous page)

```

280 abs 0000000a __PRU_CREG_RSVD10
281 abs 0000000b __PRU_CREG_UART1
282 abs 0000000c __PRU_CREG_UART2
283 abs 0000000d __PRU_CREG_RSVD13
284 abs 0000000e __PRU_CREG_DCAN0
285 abs 0000000f __PRU_CREG_DCAN1
286 abs 00000010 __PRU_CREG_MCSP11
287 abs 00000011 __PRU_CREG_I2C2
288 abs 00000012 __PRU_CREG_PWMSS0
289 abs 00000013 __PRU_CREG_PWMSS1
290 abs 00000014 __PRU_CREG_PWMSS2
291 abs 00000015 __PRU_CREG_RSVD21
292 abs 00000016 __PRU_CREG_MBX0
293 abs 00000017 __PRU_CREG_SPINLOCK
294 abs 00000018 __PRU_CREG_PRU_DMEM_0_1
295 abs 00000019 __PRU_CREG_PRU_DMEM_1_0
296 abs 0000001a __PRU_CREG_PRU_IEP
297 abs 0000001b __PRU_CREG_RSVD27
298 abs 0000001c __PRU_CREG_PRU_SHAREDMMEM
299 abs 0000001d __PRU_CREG_TPCC
300 abs 0000001e __PRU_CREG_L3OCMC
301 abs 0000001f __PRU_CREG_DDR
302 abs 00000100 __TI_STACK_SIZE
303 abs 00002000 __PRU_CREG_BASE_PRU_DMEM_1_0
304 abs 00010000 __PRU_CREG_BASE_PRU_SHAREDMMEM
305 abs 00020000 __PRU_CREG_BASE_PRU_INTC
306 abs 00026000 __PRU_CREG_BASE_PRU_CFG
307 abs 00028000 __PRU_CREG_BASE_PRU_UART
308 abs 0002e000 __PRU_CREG_BASE_PRU_IEP
309 abs 00030000 __PRU_CREG_BASE_PRU_ECAP
310 abs 00032000 __PRU_CREG_BASE_RSVD27
311 abs 00032400 __PRU_CREG_BASE_RSVD21
312 abs 40000000 __PRU_CREG_BASE_L3OCMC
313 abs 46000000 __PRU_CREG_BASE_MCASP0_DMA
314 abs 48022000 __PRU_CREG_BASE_UART1
315 abs 48024000 __PRU_CREG_BASE_UART2
316 abs 4802a000 __PRU_CREG_BASE_I2C1
317 abs 48030000 __PRU_CREG_BASE_MCSP10
318 abs 48040000 __PRU_CREG_BASE_DMTIMER2
319 abs 48060000 __PRU_CREG_BASE_MMCHS0
320 abs 480c8000 __PRU_CREG_BASE_MBX0
321 abs 480ca000 __PRU_CREG_BASE_SPINLOCK
322 abs 4819c000 __PRU_CREG_BASE_I2C2
323 abs 481a0000 __PRU_CREG_BASE_MCSP11
324 abs 481cc000 __PRU_CREG_BASE_DCAN0
325 abs 481d0000 __PRU_CREG_BASE_DCAN1
326 abs 48300000 __PRU_CREG_BASE_PWMSS0
327 abs 48302000 __PRU_CREG_BASE_PWMSS1
328 abs 48304000 __PRU_CREG_BASE_PWMSS2
329 abs 48310000 __PRU_CREG_BASE_RSVD13
330 abs 48318000 __PRU_CREG_BASE_RSVD10
331 abs 49000000 __PRU_CREG_BASE_TPCC
332 abs 4a100000 __PRU_CREG_BASE_GEMAC
333 abs 80000000 __PRU_CREG_BASE_DDR
334 abs ffffffff __binit__
335 abs ffffffff __c_args__
336 abs ffffffff binit
337
338 [100 symbols]

```

lines=1..22

Notice line 15 shows 0x18c0 bytes are being used for instructions. That's 6336 in decimal.

Now compile for the sawtooth and you see only 444 bytes are used. Floating-point requires over 5K more bytes. Use with care. If you are short on instruction space, you can move the table generation to the ARM and just copy the table to the PRU.

5.11 WS2812 (NeoPixel) driver

5.11.1 Problem

You have an Adafruit NeoPixel LED string or Adafruit NeoPixel LED matrix and want to light it up.

5.11.2 Solution

NeoPixel is Adafruit's name for the WS2812 Intelligent control LED. Each NeoPixel contains a Red, Green and Blue LED with a PWM controller that can dim each one individually making a rainbow of colors possible. The NeoPixel is driven by a single serial line. The timing on the line is very sensitive, which make the PRU a perfect candidate for driving it.

Wire the input to P9_29 and power to 3.3V and ground to ground as shown in [NeoPixel Wiring](#).

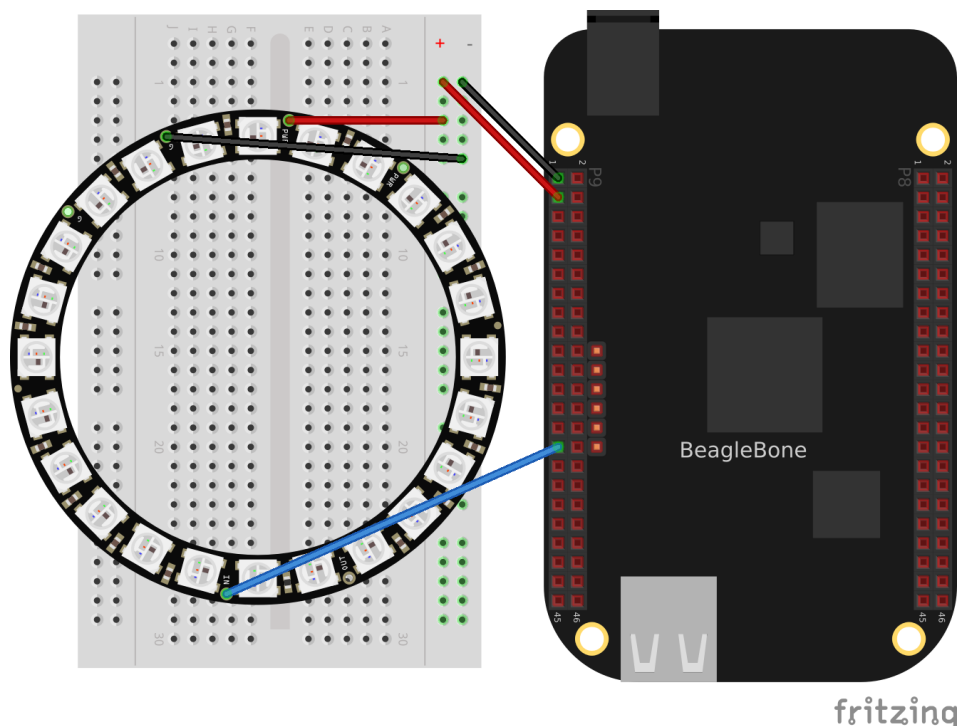

Fig. 5.21: NeoPixel Wiring

Test your wiring with the simple code in [neo1.pru0.c - Code to turn all NeoPixels's white](#) which turns all pixels white.

Listing 5.19: neo1.pru0.c - Code to turn all NeoPixels's white

```

1 // Control a ws2812 (NeoPixel) display, All on or all off
2 #include <stdint.h>
3 #include <pru_cfg.h>
4 #include "resource_table_empty.h"
5 #include "prugio.h"

```

(continues on next page)

(continued from previous page)

```

6
7 #define STR_LEN 24
8 #define oneCyclesOn 700/5 // Stay on 700ns
9 #define oneCyclesOff 800/5
10 #define zeroCyclesOn 350/5
11 #define zeroCyclesOff 600/5
12 #define resetCycles 60000/5 // Must be at least 50u,
   →use 60u
13 #define gpio P9_29 // output pin
14
15 #define ONE
16
17 volatile register uint32_t __R30;
18 volatile register uint32_t __R31;
19
20 void main(void)
21 {
22     /* Clear SYSCFG[STANDBY_INIT] to enable OCP master port */
23     CT_CFG.SYSCFG_bit.STANDBY_INIT = 0;
24
25     uint32_t i;
26     for(i=0; i<STR_LEN*3*8; i++) {
27 #ifdef ONE
28         __R30 |= gpio; // Set the GPIO pin to 1
29         __delay_cycles(oneCyclesOn-1);
30         __R30 &= ~gpio; // Clear the GPIO pin
31         __delay_cycles(oneCyclesOff-2);
32 #else
33         __R30 |= gpio; // Set the GPIO pin to 1
34         __delay_cycles(zeroCyclesOn-1);
35         __R30 &= ~gpio; // Clear the GPIO pin
36         __delay_cycles(zeroCyclesOff-2);
37 #endif
38     }
39     // Send Reset
40     __R30 &= ~gpio; // Clear the GPIO pin
41     __delay_cycles(resetCycles);
42
43     __halt();
44 }

```

neo1.pru0.c

5.11.3 Discussion

[NeoPixel bit sequence](#) (taken from [WS2812 Data Sheet](#)) shows the following waveforms are used to send a bit of data.

Table 5.10: Where the times are:

Label	Time in ns
TOH	350
TOL	800
T1H	700
T1L	600
Treset	>50,000

The code in [neo1.pru0.c - Code to turn all NeoPixels's white](#) define these times in lines 7-10. The /5 is because each instruction take 5ns. Lines 27-30 then set the output to 1 for the desired time and then to 0 and keeps

Sequence chart:

Fig. 5.22: NeoPixel bit sequence

repeating it for the entire string length. [NeoPixel zero timing](#) shows the waveform for sending a 0 value. Note the times are spot on.

Each NeoPixel listens for a RGB value. Once a value has arrived all other values that follow are passed on to the next NeoPixel which does the same thing. That way you can individually control all of the NeoPixels.

Lines 38-40 send out a reset pulse. If a NeoPixel sees a reset pulse it will grab the next value for itself and start over again.

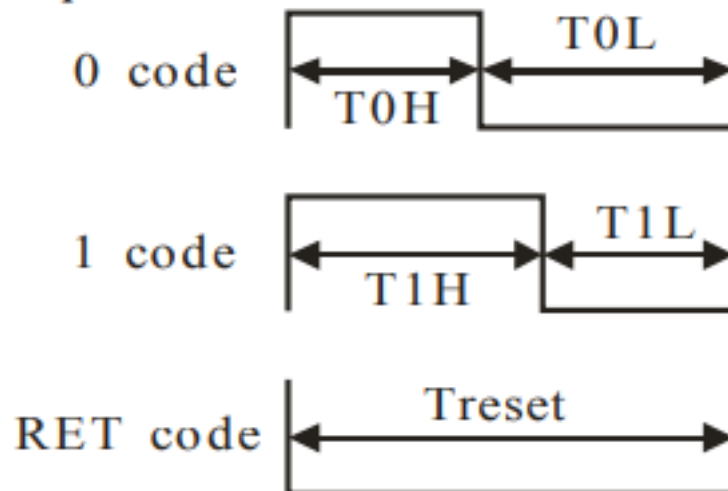
5.12 Setting NeoPixels to Different Colors

5.12.1 Problem

I want to set the LEDs to different colors.

5.12.2 Solution

Wire your NeoPixels as shown in [NeoPixel Wiring](#) then run the code in [neo2.pru0.c - Code to turn on green, red, blue](#).

Listing 5.20: neo2.pru0.c - Code to turn on green, red, blue

```

1 // Control a ws2812 (neo pixel) display, green, red, blue, green, ...
2 #include <stdint.h>
3 #include <pru_cfg.h>
4 #include "resource_table_empty.h"
5 #include "prugpio.h"
6
7 #define STR_LEN 3
8 #define oneCyclesOn 700/5 // Stay on 700ns
9 #define oneCyclesOff 800/5
10 #define zeroCyclesOn 350/5
11 #define zeroCyclesOff 600/5
12 #define resetCycles 60000/5 // Must be at least 50u,
    ↪ use 60u

```

(continues on next page)

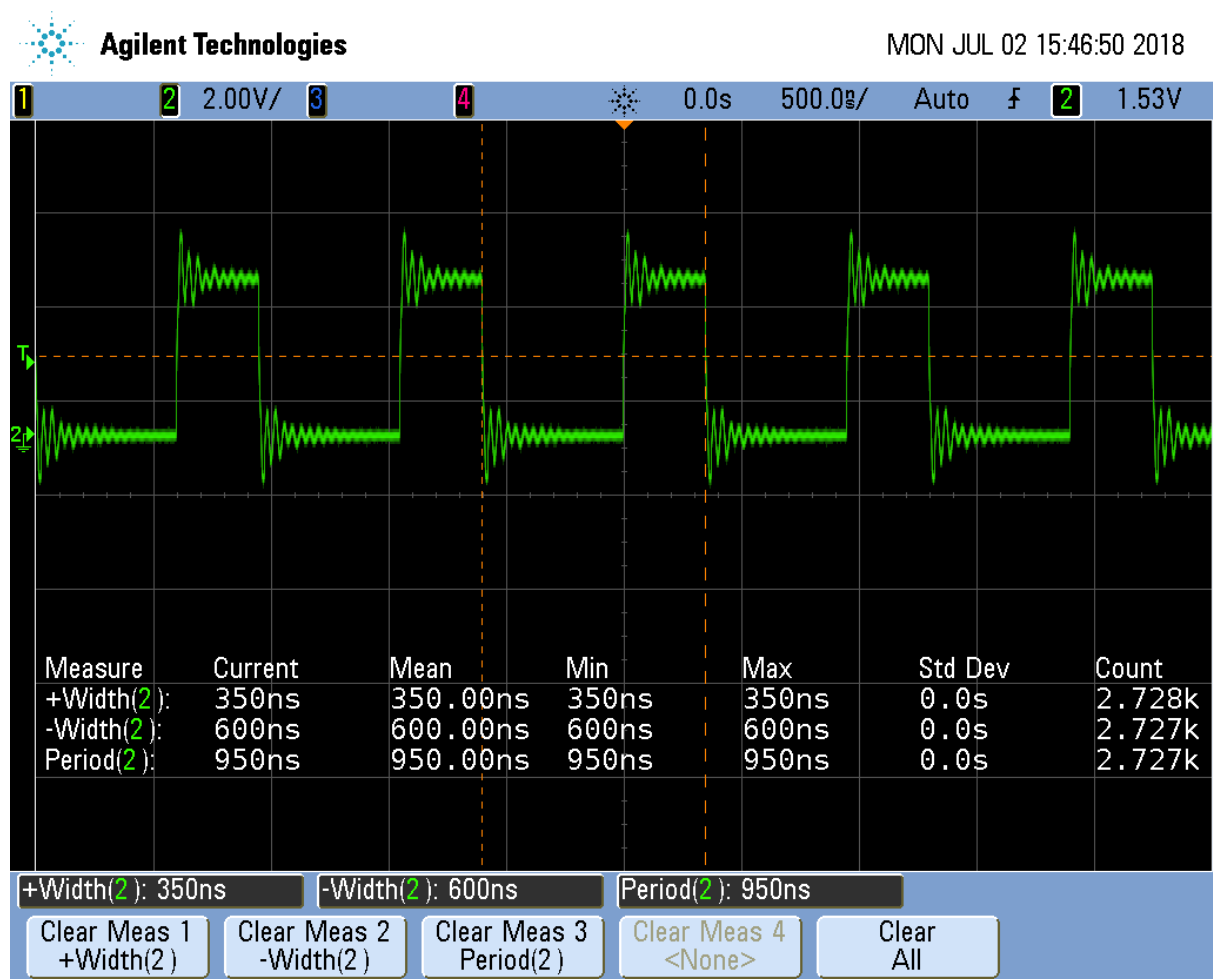

Fig. 5.23: NeoPixel zero timing

(continued from previous page)

```

13 #define gpio P9_29 // output pin
14
15 volatile register uint32_t __R30;
16 volatile register uint32_t __R31;
17
18 void main(void)
19 {
20     /* Clear SYSCFG[STANDBY_INIT] to enable OCP master port */
21     CT_CFG.SYSCFG_bit.STANDBY_INIT = 0;
22
23     uint32_t color[STR_LEN] = {0x0f0000, 0x000f00, 0x0000f}; //
    ↳green, red, blue
24     int i, j;
25
26     for(j=0; j<STR_LEN; j++) {
27         for(i=23; i>=0; i--) {
28             if(color[j] & (0x1<<i)) {
29                 __R30 |= gpio; // Set the
    ↳GPIO pin to 1
30                 __delay_cycles(oneCyclesOn-1);
31                 __R30 &= ~gpio; // Clear the
    ↳GPIO pin
32             } else {
33                 __delay_cycles(oneCyclesOff-2);
34                 __R30 |= gpio; // Set the
    ↳GPIO pin to 1
35                 __delay_cycles(zeroCyclesOn-1);
36                 __R30 &= ~gpio; // Clear the
    ↳GPIO pin
37                 __delay_cycles(zeroCyclesOff-2);
38             }
39         }
40     }
41     // Send Reset
42     __R30 &= ~gpio; // Clear the GPIO pin
43     __delay_cycles(resetCycles);
44
45     __halt();
46 }

```

neo2.pru0.c

This will make the first LED green, the second red and the third blue.

5.12.3 Discussion

[NeoPixel data sequence](#) shows the sequence of bits used to control the green, red and blue values.

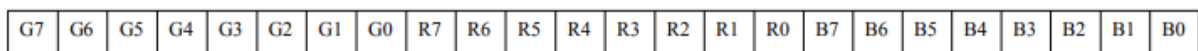

Fig. 5.24: NeoPixel data sequence

Note: The usual order for colors is RGB (red, green, blue), but the NeoPixels use GRB (green, red, blue).

[Line-by-line for neo2.pru0.c](#) is the line-by-line for neo2.pru0.c.

Table 5.11: Line-by-line for neo2.pru0.c

Line 23	Explanation Define the string of colors to be output. Here the ordering of the bits is the same as NeoPixel data sequence , GRB.
26	Loop for each color to output.
27	Loop for each bit in an GRB color.
28	Get the j^{th} color and mask off all but the i^{th} bit. ($0x1 \ll i$) takes the value $0x1$ and shifts it left i bits. When anded (&) with $color[j]$ it will zero out all but the i^{th} bit. If the result of the operation is 1, the <i>if</i> is done, otherwise the <i>else</i> is done.
29-32	Send a 1.
34-37	Send a 0.
42-43	Send a reset pulse once all the colors have been sent.

Note: This will only change the first STR_LEN LEDs. The LEDs that follow will not be changed.

5.13 Controlling Arbitrary LEDs

5.13.1 Problem

I want to change the 10th LED and not have to change the others.

5.13.2 Solution

You need to keep an array of colors for the whole string in the PRU. Change the color of any pixels you want in the array and then send out the whole string to the LEDs. [neo3.pru0.c - Code to animate a red pixel running around a ring of blue](#) shows an example animates a red pixel running around a ring of blue background. [Neo3 Video](#) shows the code in action.

Listing 5.21: neo3.pru0.c - Code to animate a red pixel running around a ring of blue

```

1 // Control a ws2812 (neo pixel) display, green, red, blue, green, ...
2 #include <stdint.h>
3 #include <pru_cfg.h>
4 #include "resource_table_empty.h"
5 #include "prugpio.h"
6
7 #define STR_LEN 24
8 #define oneCyclesOn 700/5 // Stay on 700ns
9 #define oneCyclesOff 800/5
10 #define zeroCyclesOn 350/5
11 #define zeroCyclesOff 600/5
12 #define resetCycles 60000/5 // Must be at least 50u,
13   ↳ use 60u
14 #define gpio P9_29 // output pin
15 #define SPEED 20000000/5 // Time to wait between updates
16
17 volatile register uint32_t __R30;
18 volatile register uint32_t __R31;
19
20 void main(void)
21 {
22     uint32_t background = 0x00000f;
23     uint32_t foreground = 0x000f00;

```

(continues on next page)

(continued from previous page)

```

24
25     /* Clear SYSCFG[STANDBY_INIT] to enable OCP master port */
26     CT_CFG.SYSCFG_bit.STANDBY_INIT = 0;
27
28     uint32_t color[STR_LEN];          // green, red, blue
29     int i, j;
30     int k, oldk = 0;;
31     // Set everything to background
32     for(i=0; i<STR_LEN; i++) {
33         color[i] = background;
34     }
35
36     while(1) {
37         // Move forward one position
38         for(k=0; k<STR_LEN; k++) {
39             color[oldk] = background;
40             color[k]     = foreground;
41             oldk=k;
42
43             // Output the string
44             for(j=0; j<STR_LEN; j++) {
45                 for(i=23; i>=0; i--) {
46                     if(color[j] & (0x1<<i)) {
47                         __R30 |= gpio;
48
49                         // Set the GPIO pin to 1
50                         __delay_cycles(oneCyclesOn-
51                         ↪1);
52                         __R30 &= ~gpio;
53
54                         // Clear the GPIO pin
55                         __delay_cycles(oneCyclesOff-
56                         ↪2);
57
58                         } else {
59                             __R30 |= gpio;
60
61                             // Set the GPIO pin to 1
62                             __delay_cycles(zeroCyclesOn-
63                             ↪1);
64                             __R30 &= ~gpio;
65
66                             // Clear the GPIO pin
67                             __delay_cycles(zeroCyclesOff-
68                             ↪2);
69
70                             }
71                         }
72                     // Send Reset
73                     __R30 &= ~gpio;          // Clear the GPIO pin
74                     __delay_cycles(resetCycles);
75
76                     // Wait
77                     __delay_cycles(SPEED);
78                 }
79             }
80         }
81     }

```

neo3.pru0.c

5.13.3 Neo3 Video

neo3.pru0.c - Simple animation

5.13.4 Discussion

Table 5.12: Here's the highlights.

Line	Explanation
32,33	Initialize the array of colors.
38-41	Update the array.
44-58	Send the array to the LEDs.
60-61	Send a reset.
64	Wait a bit.

5.14 Controlling NeoPixels Through a Kernel Driver

5.14.1 Problem

You want to control your NeoPixels through a kernel driver so you can control it through a `/dev` interface.

5.14.2 Solution

The `rpmsg_pru` driver provides a way to pass data between the ARM processor and the PRUs. It's already included on current images. [neo4.pru0.c - Code to talk to the PRU via rpmsg_pru](#) shows an example.

Listing 5.22: neo4.pru0.c - Code to talk to the PRU via rpmsg_pru

```

1 // Use rpmsg to control the NeoPixels via /dev/rpmsg_pru30
2 #include <stdint.h>
3 #include <stdio.h>
4 #include <stdlib.h> // atoi
5 #include <string.h>
6 #include <pru_cfg.h>
7 #include <pru_intc.h>
8 #include <rsc_types.h>
9 #include <pru_rpmsg.h>
10 #include "resource_table_0.h"
11 #include "prugpio.h"
12
13 volatile register uint32_t __R30;
14 volatile register uint32_t __R31;
15
16 /* Host-0 Interrupt sets bit 30 in register R31 */
17 #define HOST_INT ((uint32_t) 1 << 30)
18
19 /* The PRU-ICSS system events used for RPMsg are defined in the Linux device_
20  →tree
21  * PRU0 uses system event 16 (To ARM) and 17 (From ARM)
22  * PRU1 uses system event 18 (To ARM) and 19 (From ARM)
23  */
24 #define TO_ARM_HOST 16
25 #define FROM_ARM_HOST 17
26
27 /*
28  * Using the name 'rpmsg-pru' will probe the rpmsg_pru driver found
29  * at linux-x.y.z/drivers/rpmsg/rpmsg_pru.c
30  */
31 #define CHAN_NAME "rpmsg-pru"
32 #define CHAN_DESC "Channel 30"
33 #define CHAN_PORT 30

```

(continues on next page)

(continued from previous page)

```

34 /*
35  * Used to make sure the Linux drivers are ready for RPSmsg communication
36  * Found at linux-x.y.z/include/uapi/linux/virtio_config.h
37  */
38 #define VIRTIO_CONFIG_S_DRIVER_OK          4
39
40 char payload[RPSMSG_BUF_SIZE];
41
42 #define STR_LEN 24
43 #define          oneCyclesOn                700/5          // Stay on for 700ns
44 #define oneCyclesOff                600/5
45 #define zeroCyclesOn                350/5
46 #define zeroCyclesOff                800/5
47 #define resetCycles                51000/5          // Must be at least 50u,
↳use 51u
48 #define out P9_29                          // Bit number to output on
49
50 #define SPEED 20000000/5                    // Time to wait between updates
51
52 uint32_t color[STR_LEN];                  // green, red, blue
53
54 /*
55  * main.c
56  */
57 void main(void)
58 {
59     struct pru_rpsmsg_transport transport;
60     uint16_t src, dst, len;
61     volatile uint8_t *status;
62
63     uint8_t r, g, b;
64     int i, j;
65     // Set everything to background
66     for(i=0; i<STR_LEN; i++) {
67         color[i] = 0x010000;
68     }
69
70     /* Allow OCP master port access by the PRU so the PRU can read
↳external memories */
71     CT_CFG.SYSCFG_bit.STANDBY_INIT = 0;
72
73     /* Clear the status of the PRU-ICSS system event that the ARM will
↳use to 'kick' us */
74 #ifdef CHIP_IS_am57xx
75     CT_INTC.SICR_bit.STATUS_CLR_INDEX = FROM_ARM_HOST;
76 #else
77     CT_INTC.SICR_bit.STS_CLR_IDX = FROM_ARM_HOST;
78 #endif
79
80     /* Make sure the Linux drivers are ready for RPSmsg communication */
81     status = &resourceTable.rpsmsg_vdev.status;
82     while (!(*status & VIRTIO_CONFIG_S_DRIVER_OK));
83
84     /* Initialize the RPSmsg transport structure */
85     pru_rpsmsg_init(&transport, &resourceTable.rpsmsg_vring0, &
↳resourceTable.rpsmsg_vring1, TO_ARM_HOST, FROM_ARM_HOST);
86
87     /* Create the RPSmsg channel between the PRU and ARM user space using
↳the transport structure. */
88     while (pru_rpsmsg_channel(RPSMSG_NS_CREATE, &transport, CHAN_NAME,
↳CHAN_DESC, CHAN_PORT) != PRU_RPSMSG_SUCCESS);

```

(continues on next page)

(continued from previous page)

```

89     while (1) {
90         /* Check bit 30 of register R31 to see if the ARM has kicked
↳us */
91         if (__R31 & HOST_INT) {
92             /* Clear the event status */
93             #ifdef CHIP_IS_am57xx
94                 CT_INTC.SICR_bit.STATUS_CLR_INDEX = FROM_ARM_HOST;
95             #else
96                 CT_INTC.SICR_bit.STS_CLR_IDX = FROM_ARM_HOST;
97             #endif
98             /* Receive all available messages, multiple messages
↳can be sent per kick */
99             while (pru_rpmsg_receive(&transport, &src, &dst,
↳payload, &len) == PRU_RPMSG_SUCCESS) {
100                 char *ret;          // rest of payload after front
↳character is removed
101                 int index;          // index of LED to control
102                 // Input format is: index red green blue
103                 index = atoi(payload);
104                 // Update the array, but don't write it out.
105                 if((index >=0) & (index < STR_LEN)) {
106                     ret = strchr(payload, ' ');          //
↳Skip over index
107                     r = strtol(&ret[1], NULL, 0);
108                     ret = strchr(&ret[1], ' ');          //
↳Skip over r, etc.
109                     g = strtol(&ret[1], NULL, 0);
110                     ret = strchr(&ret[1], ' ');
111                     b = strtol(&ret[1], NULL, 0);
112
113                     color[index] = (g<<16) | (r<<8) | b;          /
↳/ String wants GRB
114                 }
115                 // When index is -1, send the array to the LED
↳string
116                 if(index == -1) {
117                     // Output the string
118                     for(j=0; j<STR_LEN; j++) {
119                         // Cycle through each bit
120                         for(i=23; i>=0; i--) {
121                             if(color[j] & (0x1<
↳<i)) {
122                                 __R30 |= out;
123                                 // Set the GPIO pin to 1
↳cycles(oneCyclesOn-1);
124                                 __R30 &= ~
↳out;          // Clear the GPIO pin
125                                 __delay_
↳cycles(oneCyclesOff-14);
126                             } else {
127                                 __R30 |= out;
128                                 // Set the GPIO pin to 1
↳cycles(zeroCyclesOn-1);
129                                 __R30 &= ~
↳(out);          // Clear the GPIO pin
130                                 __delay_
↳cycles(zeroCyclesOff-14);
131                             }
132                     }

```

(continues on next page)

(continued from previous page)

```

133     }
134     // Send Reset
135     __R30 &= ~out;           // Clear the
136     __delay_cycles(resetCycles);
137
138     // Wait
139     __delay_cycles(SPEED);
140 }
141 }
142 }
143 }
144 }
145 }

```

neo4.pru0.c

Run the code as usual.

```

bone$ make TARGET=neo4.pru0
/opt/source/pru-cookbook-code/common/Makefile:29: MODEL=TI_AM335x_BeagleBone_
↳Black, TARGET=neo4.pru0
- Stopping PRU 0
- copying firmware file /tmp/vsx-examples/neo4.pru0.out to /lib/firmware/
↳am335x-pru0-fw
write_init_pins.sh
- Starting PRU 0
MODEL = TI_AM335x_BeagleBone_Black
PROC = pru
PRUN = 0
PRU_DIR = /sys/class/remoteproc/remoteproc1

bone$ echo 0 0xff 0 127 > /dev/rpmsg_pru30
bone$ echo -1 > /dev/rpmsg_pru30

```

Todo: get this working on the 5.10 kernel

`/dev/rpmsg_pru30` is a device driver that lets the ARM talk to the PRU. The first `echo` says to set the 0th LED to RGB value 0xff 0 127. (Note: you can mix hex and decimal.) The second `echo` tells the driver to send the data to the LEDs. Your 0th LED should now be lit.

5.14.3 Discussion

There's a lot here. I'll just hit some of the highlights in [Line-by-line for neo4.pru0.c](#).

Table 5.13: Line-by-line for neo4.pru0.c

Line	Explanation
30	The <code>CHAN_NAME</code> of <code>rpmsg-pru</code> matches that <code>prmsg_pru</code> driver that is already installed. This connects this PRU to the driver.
32	The <code>CHAN_PORT</code> tells it to use port 30. That's why we use <code>/dev/rpmsg_pru30</code>
40	<code>payload[]</code> is the buffer that receives the data from the ARM.
42-48	Same as the previous NeoPixel examples.
52	<code>color[]</code> is the state to be sent to the LEDs.
66-68	<code>color[]</code> is initialized.
70-85	Here are a number of details needed to set up the channel between the PRU and the ARM.
88	Here we wait until the ARM sends us some numbers.
99	Receive all the data from the ARM, store it in <code>payload[]</code> .
101-111	The data sent is: index red green blue. Pull off the index. If it's in the right range, pull off the red, green and blue values.
113	The NeoPixels want the data in GRB order. Shift and OR everything together.
116-133	If the <code>index = -1</code> , send the contents of <code>color</code> to the LEDs. This code is same as before.

You can now use programs running on the ARM to send colors to the PRU.

[neo-rainbow.py](#) - A python program using `/dev/rpmsg_pru30` shows an example.

Listing 5.23: neo-rainbow.py - A python program using `/dev/rpmsg_pru30`

```

1  #!/usr/bin/python3
2  from time import sleep
3  import math
4
5  len = 24
6  amp = 12
7  f = 25
8  shift = 3
9  phase = 0
10
11 # Open a file
12 fo = open("/dev/rpmsg_pru30", "wb", 0)
13
14 while True:
15     for i in range(0, len):
16         r = (amp * (math.sin(2*math.pi*f*(i-phase-0*shift)/len) + 1)) + 1;
17         g = (amp * (math.sin(2*math.pi*f*(i-phase-1*shift)/len) + 1)) + 1;
18         b = (amp * (math.sin(2*math.pi*f*(i-phase-2*shift)/len) + 1)) + 1;
19         fo.write(b"%d %d %d %d\n" % (i, r, g, b))
20         # print("0 0 127 %d" % (i))
21
22         fo.write(b"-1 0 0 0\n");
23         phase = phase + 1
24         sleep(0.05)
25
26 # Close opened file
27 fo.close()

```

neo-rainbow.py

Line 19 writes the data to the PRU. Be sure to have a newline, or space after the last number, or you numbers will get blurred together.

Switching from pru0 to pru1 with rpmsg_pru

There are three things you need to change when switching from pru0 to pru1 when using `rpmsg_pru`.

1. The include on line 10 is switched to `#include "resource_table_1.h"` (0 is switched to a 1)

2. Line 17 is switched to `#define HOST_INT ((uint32_t) 1 << 31)` (30 is switched to 31.)
3. Lines 23 and 24 are switched to:

```
#define TO_ARM_HOST          18
#define FROM_ARM_HOST       19
```

These changes switch to the proper channel numbers to use pru1 instead of pru0.

5.15 RGB LED Matrix - No Integrated Drivers

5.15.1 Problem

You have a RGB LED matrix (*RGB LED Matrix - No Integrated Drivers (Falcon Christmas)*) and want to know at a low level how the PRU works.

5.15.2 Solution

Here is the [datasheet](#), but the best description I've found for the RGB Matrix is from [Adafruit](#). I've reproduced it here, with adjustments for the 64x32 matrix we are using.

information

There's zero documentation out there on how these matrices work, and no public datasheets or spec sheets so we are going to try to document how they work.

First thing to notice is that there are 2048 RGB LEDs in a 64x32 matrix. Like pretty much every matrix out there, you can't drive all 2048 at once. One reason is that would require a lot of current, another reason is that it would be really expensive to have so many pins. Instead, the matrix is divided into 16 interleaved sections/strips. The first section is the 1st 'line' and the 17th 'line' (64 x 2 RGB LEDs = 128 RGB LEDs), the second is the 2nd and 18th line, etc until the last section which is the 16th and 32nd line. You might be asking, why are the lines paired this way? wouldn't it be nicer to have the first section be the 1st and 2nd line, then 3rd and 4th, until the 15th and 16th? The reason they do it this way is so that the lines are interleaved and look better when refreshed, otherwise we'd see the stripes more clearly.

So, on the PCB is 24 LED driver chips. These are like 74HC595s but they have 16 outputs and they are constant current. 16 outputs * 24 chips = 384 LEDs that can be controlled at once, and 128 * 3 (R G and B) = 384. So now the design comes together: You have 384 outputs that can control one line at a time, with each of 384 R, G and B LEDs either on or off. The controller (say an FPGA or microcontroller) selects which section to currently draw (using LA, LB, LC and LD address pins - 4 bits can have 16 values). Once the address is set, the controller clocks out 384 bits of data (48 bytes) and latches it. Then it increments the address and clocks out another 384 bits, etc until it gets to address #15, then it sets the address back to #0

<https://cdn-learn.adafruit.com/downloads/pdf/32x16-32x32-rgb-led-matrix.pdf>

That gives a good overview, but there are a few details missing. [rgb_python.py - Python code for driving RGB LED matrix](#) is a functioning python program that gives a nice high-level view of how to drive the display.

Todo: Test this

Listing 5.24: rgb_python.py - Python code for driving RGB LED matrix

```
1 #!/usr/bin/env python3
2 import Adafruit_BBIO.GPIO as GPIO
3
4 # Define which functions are connect to which pins
```

(continues on next page)

(continued from previous page)

```

5 OE="P1_29"      # Output Enable, active low
6 LAT="P1_36"    # Latch, toggle after clocking in a row of pixels
7 CLK="P1_33"    # Clock, toggle after each pixel
8
9 # Input data pins
10 R1="P2_10"    # R1, G1, B1 are for the top rows (1-16) of pixels
11 G1="P2_8"
12 B1="P2_6"
13
14 R2="P2_4"      # R2, G2, B2 are for the bottom rows (17-32) of pixels
15 G2="P2_2"
16 B2="P2_1"
17
18 LA="P2_32"    # Address lines for which row (1-16 or 17-32) to update
19 LB="P2_30"
20 LC="P1_31"
21 LD="P2_34"
22
23 # Set everything as output ports
24 GPIO.setup(OE, GPIO.OUT)
25 GPIO.setup(LAT, GPIO.OUT)
26 GPIO.setup(CLK, GPIO.OUT)
27
28 GPIO.setup(R1, GPIO.OUT)
29 GPIO.setup(G1, GPIO.OUT)
30 GPIO.setup(B1, GPIO.OUT)
31 GPIO.setup(R2, GPIO.OUT)
32 GPIO.setup(G2, GPIO.OUT)
33 GPIO.setup(B2, GPIO.OUT)
34
35 GPIO.setup(LA, GPIO.OUT)
36 GPIO.setup(LB, GPIO.OUT)
37 GPIO.setup(LC, GPIO.OUT)
38 GPIO.setup(LD, GPIO.OUT)
39
40 GPIO.output(OE, 0)      # Enable the display
41 GPIO.output(LAT, 0)    # Set latch to low
42
43 while True:
44     for bank in range(64):
45         GPIO.output(LA, bank>>0&0x1)    # Select rows
46         GPIO.output(LB, bank>>1&0x1)
47         GPIO.output(LC, bank>>2&0x1)
48         GPIO.output(LD, bank>>3&0x1)
49
50         # Shift the colors out. Here we only have four different
51         # colors to keep things simple.
52         for i in range(16):
53             GPIO.output(R1, 1)          # Top row, white
54             GPIO.output(G1, 1)
55             GPIO.output(B1, 1)
56
57             GPIO.output(R2, 1)          # Bottom row, red
58             GPIO.output(G2, 0)
59             GPIO.output(B2, 0)
60
61             GPIO.output(CLK, 0)         # Toggle clock
62             GPIO.output(CLK, 1)
63
64             GPIO.output(R1, 0)          # Top row, black
65             GPIO.output(G1, 0)

```

(continues on next page)

(continued from previous page)

```

66         GPIO.output (B1, 0)
67
68         GPIO.output (R2, 0)      # Bottom row, green
69         GPIO.output (G2, 1)
70         GPIO.output (B2, 0)
71
72         GPIO.output (CLK, 0)     # Toggle clock
73         GPIO.output (CLK, 1)
74
75         GPIO.output (OE, 1)      # Disable display while updating
76         GPIO.output (LAT, 1)     # Toggle latch
77         GPIO.output (LAT, 0)
78         GPIO.output (OE, 0)      # Enable display

```

rgb_python.py

Be sure to run the [rgb_python_setup.sh](#) script before running the python code.

Listing 5.25: rgb_python_setup.sh

```

1  #!/bin/bash
2  # Setup for 64x32 RGB Matrix
3  export TARGET=rgb1.pru0
4  echo TARGET=$TARGET
5
6  # Configure the PRU pins based on which Beagle is running
7  machine=$(awk '{print $NF}' /proc/device-tree/model)
8  echo -n $machine
9  if [ $machine = "Black" ]; then
10     echo " Found"
11     pins=""
12  elif [ $machine = "Blue" ]; then
13     echo " Found"
14     pins=""
15  elif [ $machine = "PocketBeagle" ]; then
16     echo " Found"
17     prupins="P2_32 P1_31 P1_33 P1_29 P2_30 P2_34 P1_36"
18     gpiopins="P2_10 P2_06 P2_04 P2_01 P2_08 P2_02"
19     # Uncomment for J2
20     # gpiopins="$gpiopins P2_27 P2_25 P2_05 P2_24 P2_22 P2_18"
21  else
22     echo " Not Found"
23     pins=""
24  fi
25
26  for pin in $prupins
27  do
28     echo $pin
29     # config-pin $pin pruout
30     config-pin $pin gpio
31     config-pin $pin out
32     config-pin -q $pin
33  done
34
35  for pin in $gpiopins
36  do
37     echo $pin
38     config-pin $pin gpio
39     config-pin $pin out
40     config-pin -q $pin
41  done

```

```
rgb_python_setup.sh
```

Make sure line 29 is commented out and line 30 is uncommented. Later we'll configure for `_pruout_`, but for now the python code doesn't use the PRU outs.

```
# config-pin $pin pruout
config-pin $pin out
```

Your display should look like *Display running rgb_python.py*.

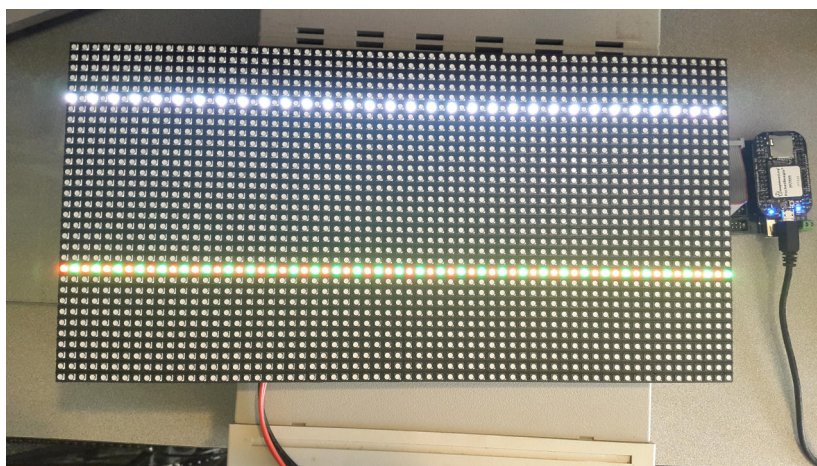

Fig. 5.25: Display running `rgb_python.py`

So why do only two lines appear at a time? That's how the display works. Currently lines 6 and 22 are showing, then a moment later 7 and 23 show, etc. The display can only display two lines at a time, so it cycles through all the lines. Unfortunately, python is too slow to make the display appear all at once. Here's where the PRU comes in.

`:ref:blocks_rgb1` is the PRU code to drive the RGB LED matrix. Be sure to run `bone$ source rgb_setup.sh` first.

Listing 5.26: PRU code for driving the RGB LED matrix

```
1 // This code drives the RGB LED Matrix on the 1st Connector
2 #include <stdint.h>
3 #include <pru_cfg.h>
4 #include "resource_table_empty.h"
5 #include "prugpio.h"
6 #include "rgb_pocket.h"
7
8 #define DELAY 10 // Number of cycles (5ns each) to wait after a write
9
10 volatile register uint32_t __R30;
11 volatile register uint32_t __R31;
12
13 void main(void)
14 {
15     // Set up the pointers to each of the GPIO ports
16     uint32_t *gpio[] = {
17         (uint32_t *) GPIO0,
18         (uint32_t *) GPIO1,
19         (uint32_t *) GPIO2,
20         (uint32_t *) GPIO3
21     };
22
23     uint32_t i, row;
```

(continues on next page)

(continued from previous page)

```

25     while(1) {
26         for(row=0; row<16; row++) {
27             // Set the row address
28             // Here we take advantage of the select bits (LA, LB,
↳LC, LD)
29             // being sequential in the R30 register (bits 2,3,4,
↳5)
30             // We shift row over so it lines up with the select_
↳bits
31             // Oring (!=) with R30 sets bits to 1 and
32             // Anding (&=) clears bits to 0, the 0xffc mask_
↳makes sure the
33             // other bits aren't changed.
34             __R30 |= row<<pru_sel0;
35             __R30 &= (row<<pru_sel0)|0xffc3;
36
37             for(i=0; i<64; i++) {
38                 // Top row white
39                 // Combining these to one write works because they_
↳are all in
40                 // the same gpio port
41                 gpio[r11_gpio][GPIO_SETDATAOUT] = r11_pin | g11_
↳pin | b11_pin;
42                 __delay_cycles(DELAY);;
43
44                 // Bottom row red
45                 gpio[r12_gpio][GPIO_SETDATAOUT] = r12_pin;
46                 __delay_cycles(DELAY);
47                 gpio[r12_gpio][GPIO_CLEARDATAOUT] = g12_pin | b12_
↳pin;
48                 __delay_cycles(DELAY);
49
50                 __R30 |= pru_clock; // Toggle clock
51                 __delay_cycles(DELAY);
52                 __R30 &= ~pru_clock;
53                 __delay_cycles(DELAY);
54
55                 // Top row black
56                 gpio[r11_gpio][GPIO_CLEARDATAOUT] = r11_pin | g11_
↳pin | b11_pin;
57                 __delay_cycles(DELAY);
58
59                 // Bottom row green
60                 gpio[r12_gpio][GPIO_CLEARDATAOUT] = r12_pin | b12_
↳pin;
61                 __delay_cycles(DELAY);
62                 gpio[r12_gpio][GPIO_SETDATAOUT] = g12_pin;
63                 __delay_cycles(DELAY);
64
65                 __R30 |= pru_clock; // Toggle clock
66                 __delay_cycles(DELAY);
67                 __R30 &= ~pru_clock;
68                 __delay_cycles(DELAY);
69             }
70             __R30 |= pru_oe; // Disable display
71             __delay_cycles(DELAY);
72             __R30 |= pru_latch; // Toggle latch
73             __delay_cycles(DELAY);
74             __R30 &= ~pru_latch;
75             __delay_cycles(DELAY);
76             __R30 &= ~pru_oe; // Enable display

```

(continues on next page)

(continued from previous page)

```

77         __delay_cycles (DELAY);
78     }
79 }
80 }

```

rgb1.pru0.c

The results are shown in [Display running rgb1.c on PRU 0](#).

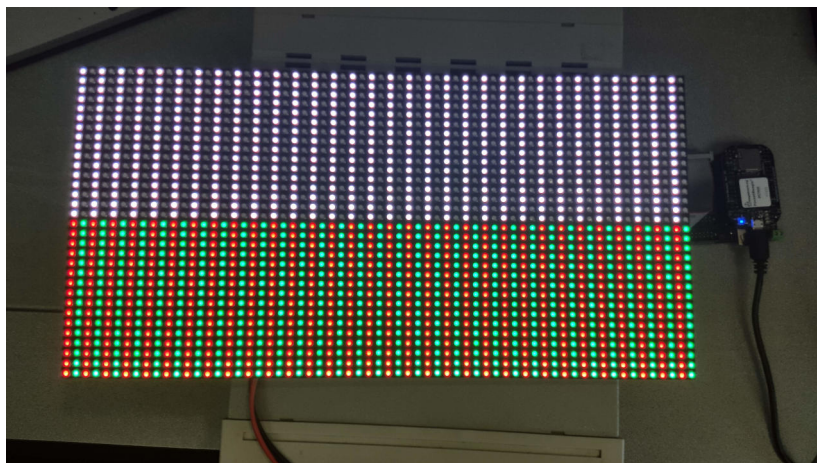

Fig. 5.26: Display running rgb1.c on PRU 0

The PRU is fast enough to quickly write to the display so that it appears as if all the LEDs are on at once.

5.15.3 Discussion

There are a lot of details needed to make this simple display work. Let's go over some of them.

First, the connector looks like [RGB Matrix J1 connector](#).

Notice the labels on the connect match the labels in the code. [PocketScroller pin table](#) shows how the pins on the display are mapped to the pins on the PocketBeagle.

Todo: Make a mapping table for the Black

<https://github.com/FalconChristmas/fpp/blob/master/src/pru/OctoscrollerV2.hp>

Table 5.14: PocketScroller pin table

J1 Connector Pin	Pocket Headers	gpio port and bit number	Linux gpio number	PRU R30 bit number
R1	P2_10	1-20	52	
B1	P2_06	1-25	57	
R2	P2_04	1-26	58	
B2	P2_01	1-18	50	
LA	P2_32	3-16	112	PRU0.2
LC	P1_31	3-18	114	PRU0.4
CLK	P1_33	3-15	111	PRU0.1
OE	P1_29	3-21	117	PRU0.7
G1	P2_08	1-28	60	
G2	P2_02	1-27	59	
LB	P2_30	3-17	113	PRU0.3
LD	P2_34	3-19	115	PRU0.5
LAT	P1_36	3-14	110	PRU0.0

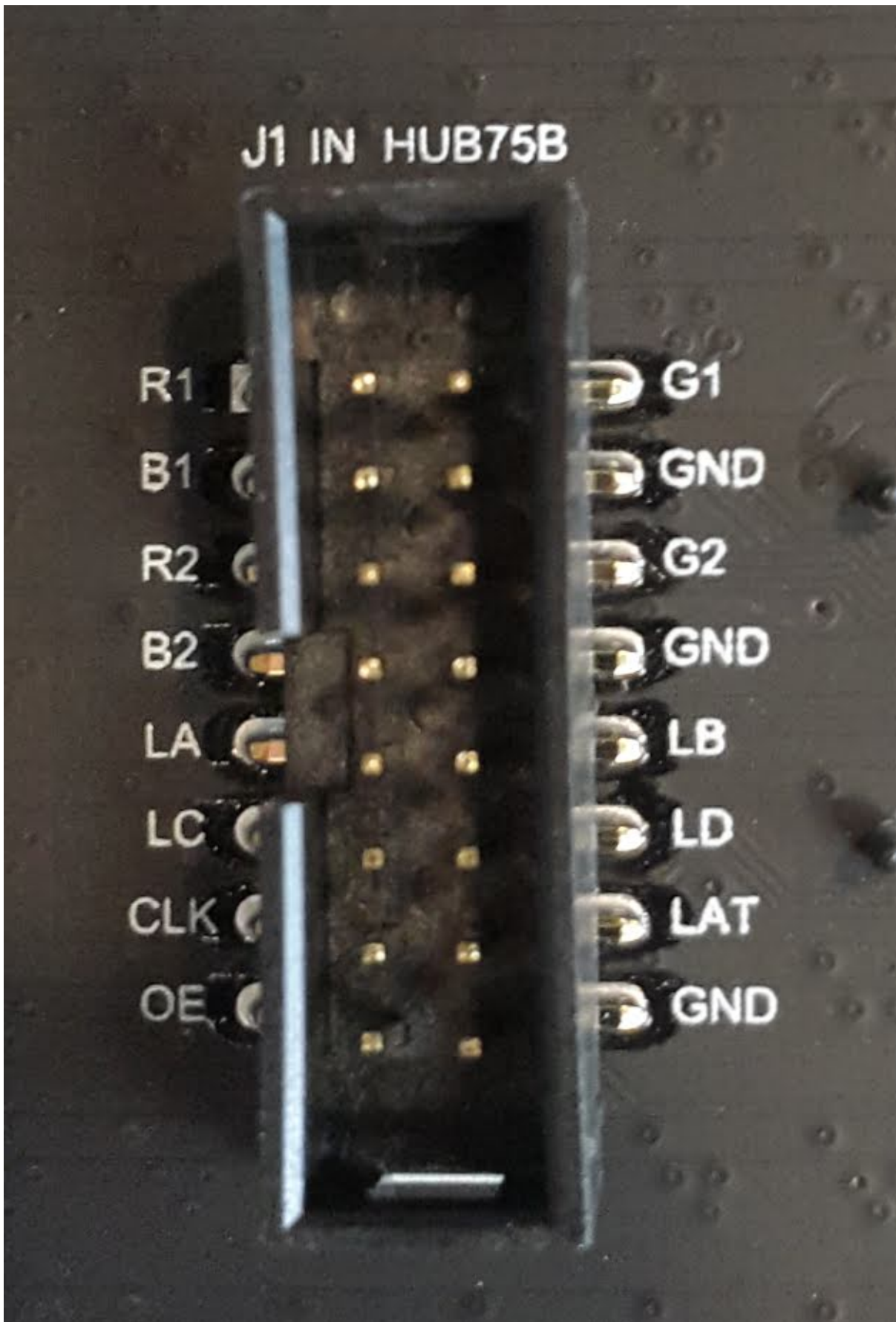

Fig. 5.27: RGB Matrix J1 connector

The J1 mapping to gpio port and bit number comes from <https://github.com/FalconChristmas/fpp/blob/master/capes/pb/panels/PocketScroller.json>. The gpio port and bit number mapping to Pocket Headers comes from <https://docs.google.com/spreadsheets/d/1FRGvYOyW1RiNSEVprvstfjAVeapnASgDXHtxeDOjgqw/edit#gid=0>.

Oscilloscope display of CLK, OE, LAT and R1 shows four of the signal waveforms driving the RGB LED matrix.

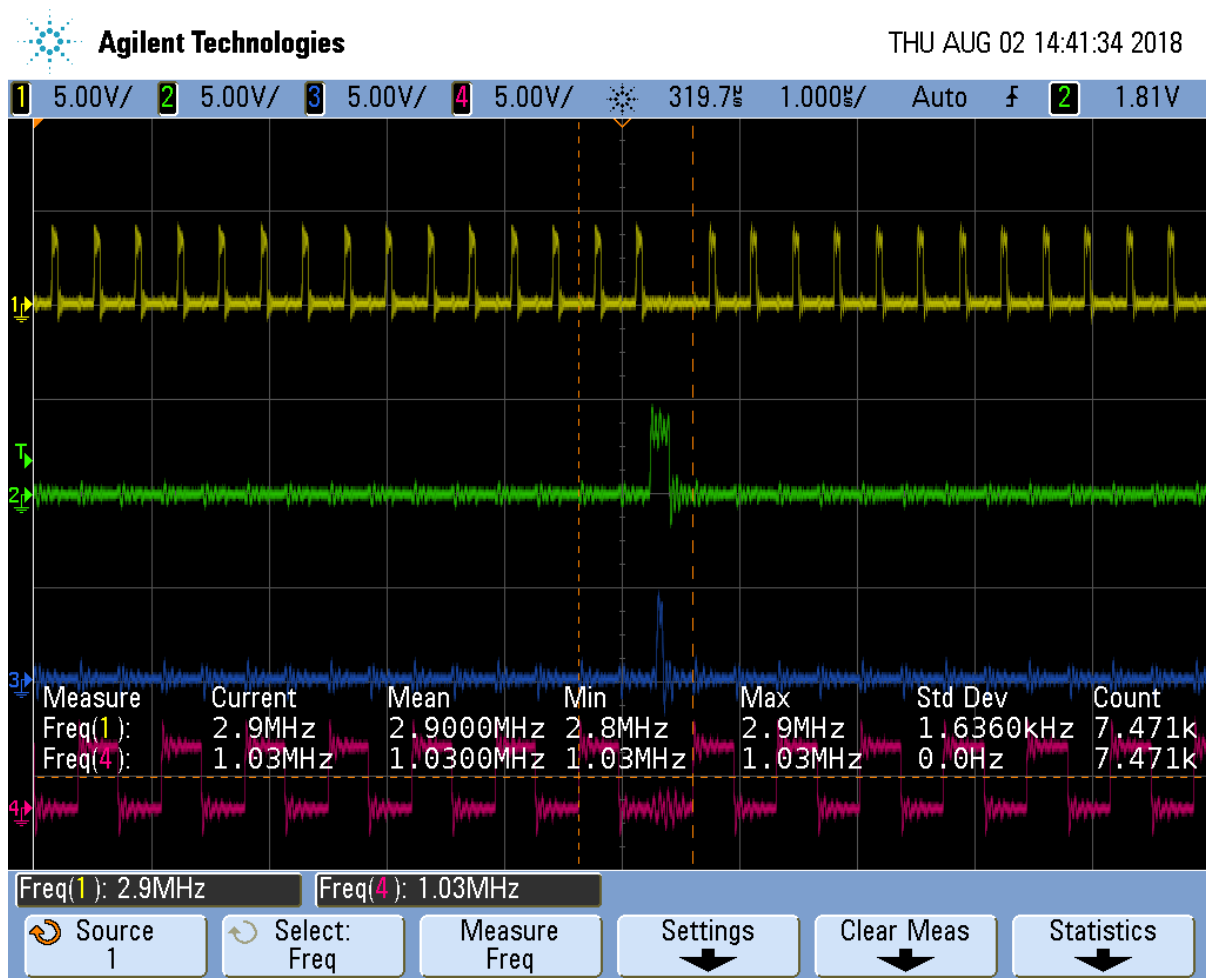

Fig. 5.28: Oscilloscope display of CLK, OE, LAT and R1

The top waveform is the CLK, the next is OE, followed by LAT and finally R1. The OE (output enable) is active low, so most of the time the display is visible. The sequence is:

- Put data on the R1, G1, B1, R2, G2 and B2 lines
- Toggle the clock.
- Repeat the first two steps as one row of data is transferred. There are 384 LEDs (2 rows of 32 RGB LEDs times 3 LED per RGB), but we are clocking in six bits (R1, G1, etc.) at a time, so $384/6=64$ values need to be clocked in.
- Once all the values are in, disable the display (OE goes high)
- Then toggle the latch (LAT) to latch the new data.
- Turn the display back on.
- Increment the address lines (LA, LB, LC and LD) to point to the next rows.
- Keep repeating the above to keep the display lit.

Using the PRU we are able to run the clock at about 2.9 MHz. *FPP waveforms* shows the optimized assembler code used by FPP clocks in at some 6.3 MHz. So the compiler is doing a pretty good job, but you can run some

two times faster if you want to use assembly code. In fairness to FPP, it's having to pull it's data out of RAM to display it, so isn't not a good comparison.

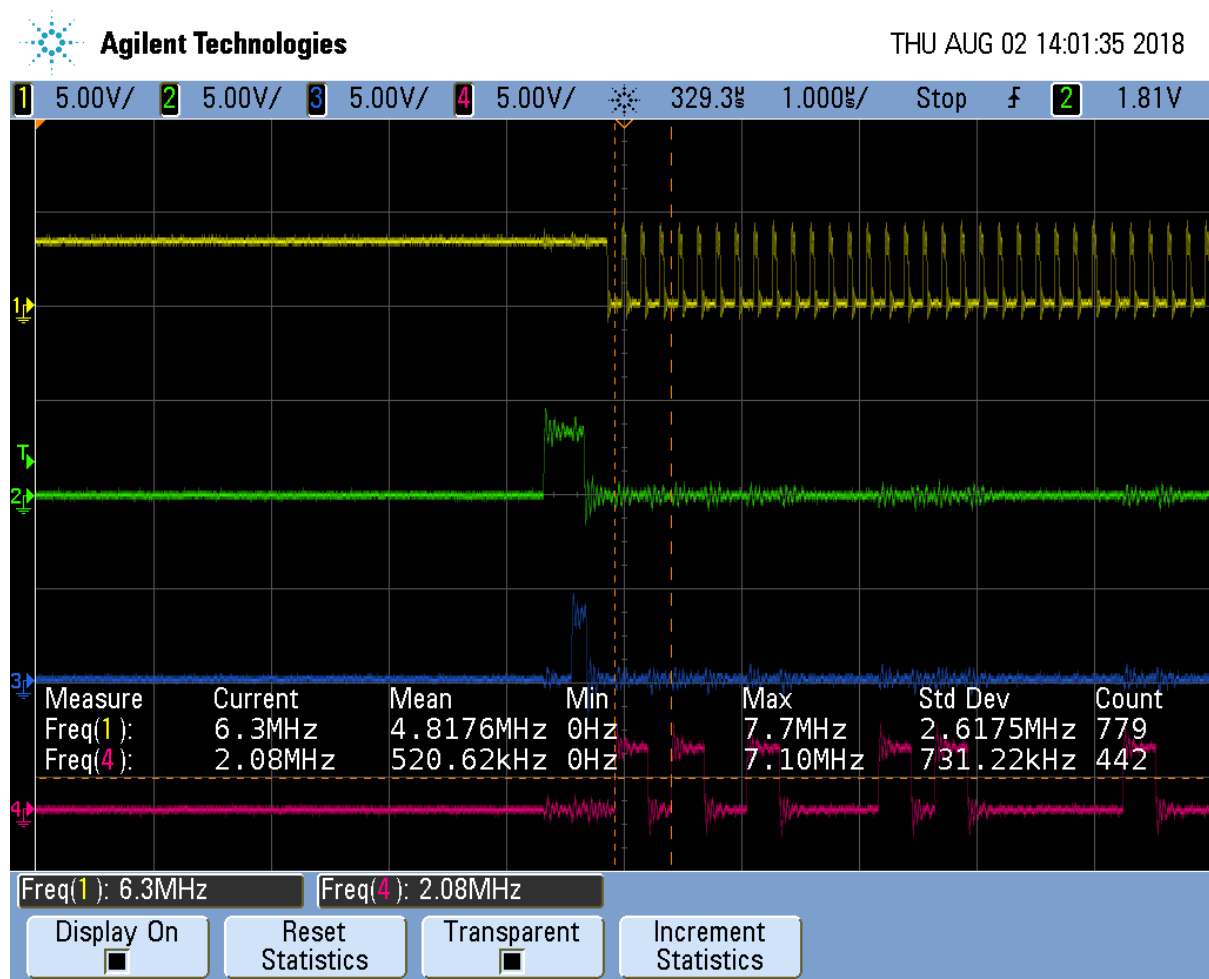

Fig. 5.29: FPP waveforms

Getting More Colors

The Adafruit description goes on to say:

information

The only downside of this technique is that despite being very simple and fast, it has no PWM control built-in! The controller can only set the LEDs on or off. So what do you do when you want full color? You actually need to draw the entire matrix over and over again at very high speeds to PWM the matrix manually. For that reason, you need to have a very fast controller (50 MHz is a minimum) if you want to do a lot of colors and motion video and have it look good.

<https://cdn-learn.adafruit.com/downloads/pdf/32x16-32x32-rgb-led-matrix.pdf>

This is what FPP does, but it's beyond the scope of this project.

5.16 Compiling and Inserting rpmsg_pru

5.16.1 Problem

Your Beagle doesn't have `rpmsg_pru`.

5.16.2 Solution

Do the following.

```
bone$ *cd code/05blocks/module*
bone$ *sudo apt install linux-headers-`uname -r`*
bone$ *wget https://github.com/beagleboard/linux/raw/4.9/drivers/rpmsg/rpmsg_
→pru.c*
bone$ *make*
make -C /lib/modules/4.9.88-ti-r111/build M=$PWD
make[1]: Entering directory '/usr/src/linux-headers-4.9.88-ti-r111'
  LD      /home/debian/PRUCookbook/docs/code/05blocks/module/built-in.o
  CC [M]  /home/debian/PRUCookbook/docs/code/05blocks/module/rpmsg_client_
→sample.o
  CC [M]  /home/debian/PRUCookbook/docs/code/05blocks/module/rpmsg_pru.o
  Building modules, stage 2.
  MODPOST 2 modules
  CC      /home/debian/PRUCookbook/docs/code/05blocks/module/rpmsg_client_
→sample.mod.o
  LD [M]  /home/debian/PRUCookbook/docs/code/05blocks/module/rpmsg_client_
→sample.ko
  CC      /home/debian/PRUCookbook/docs/code/05blocks/module/rpmsg_pru.mod.o
  LD [M]  /home/debian/PRUCookbook/docs/code/05blocks/module/rpmsg_pru.ko
make[1]: Leaving directory '/usr/src/linux-headers-4.9.88-ti-r111'
bone$ *sudo insmod rpmsg_pru.ko*
bone$ *lsmod | grep rpm*
rpmsg_pru                5799  2
virtio_rpmsg_bus         13620  0
rpmsg_core                8537  2 rpmsg_pru,virtio_rpmsg_bus
```

It's now installed and ready to go.

5.17 Copyright

Listing 5.27: `copyright.c`

```
1  /*
2  * Copyright (C) 2015 Texas Instruments Incorporated - http://www.ti.com/
3  *
4  *
5  * Redistribution and use in source and binary forms, with or without
6  * modification, are permitted provided that the following conditions
7  * are met:
8  *
9  *     * Redistributions of source code must retain the above copyright
10 *       notice, this list of conditions and the following disclaimer.
11 *
12 *     * Redistributions in binary form must reproduce the above copyright
13 *       notice, this list of conditions and the following disclaimer in
→the
14 *       documentation and/or other materials provided with the
15 *       distribution.
16 *
17 *     * Neither the name of Texas Instruments Incorporated nor the names
→of
```

(continues on next page)

(continued from previous page)

```
18 *           its contributors may be used to endorse or promote products.
↳derived
19 *           from this software without specific prior written permission.
20 *
21 * THIS SOFTWARE IS PROVIDED BY THE COPYRIGHT HOLDERS AND CONTRIBUTORS
22 * "AS IS" AND ANY EXPRESS OR IMPLIED WARRANTIES, INCLUDING, BUT NOT
23 * LIMITED TO, THE IMPLIED WARRANTIES OF MERCHANTABILITY AND FITNESS FOR
24 * A PARTICULAR PURPOSE ARE DISCLAIMED. IN NO EVENT SHALL THE COPYRIGHT
25 * OWNER OR CONTRIBUTORS BE LIABLE FOR ANY DIRECT, INDIRECT, INCIDENTAL,
26 * SPECIAL, EXEMPLARY, OR CONSEQUENTIAL DAMAGES (INCLUDING, BUT NOT
27 * LIMITED TO, PROCUREMENT OF SUBSTITUTE GOODS OR SERVICES; LOSS OF USE,
28 * DATA, OR PROFITS; OR BUSINESS INTERRUPTION) HOWEVER CAUSED AND ON ANY
29 * THEORY OF LIABILITY, WHETHER IN CONTRACT, STRICT LIABILITY, OR TORT
30 * (INCLUDING NEGLIGENCE OR OTHERWISE) ARISING IN ANY WAY OUT OF THE USE
31 * OF THIS SOFTWARE, EVEN IF ADVISED OF THE POSSIBILITY OF SUCH DAMAGE.
32 */
```

copyright.c

Chapter 6

Accessing More I/O

So far the examples have shown how to access the GPIO pins on the BeagleBone Black's P9 header and through the `pass : [__]R30` register. Below shows how more GPIO pins can be accessed.

The following are resources used in this chapter.

Note: *Resources*

- P8 Header Table
 - P9 Header Table
 - AM572x Technical Reference Manual (AI)
 - AM335x Technical Reference Manual (All others)
 - PRU Assembly Language Tools
-

6.1 Editing /boot/uEnv.txt to Access the P8 Header on the Black

6.1.1 Problem

When I try to configure some pins on the P8 header of the Black I get an error.

```
1 bone$ *config-pin P8_28 pruout*
2 ERROR: open() for /sys/devices/platform/ocp/ocp:P8_28_pinmux/state failed,
  ↳No such file or directory
```

6.1.2 Solution

On the images for the BeagleBone Black, the HDMI display driver is enabled by default and uses many of the P8 pins. If you are not using HDMI video (or the HDI audio, or even the eMMC) you can disable it by editing `/boot/uEnv.txt`

Open `/boot/uEnv.txt` and scroll down always until you see:

Listing 6.1: `/boot/uEnv.txt`

```
1 ###Disable auto loading of virtual capes (emmc/video/wireless/adc)
2 #disable_uboot_overlay_emmc=1
3 disable_uboot_overlay_video=1
4 #disable_uboot_overlay_audio=1
```

Uncomment the lines that correspond to the devices you want to disable and free up their pins.

Tip: P8 Header Table shows what pins are allocated for what.

Save the file and reboot. You now have access to the P8 pins.

6.2 Accessing gpio

6.2.1 Problem

I've used up all the GPIO in pass : [__] R30, where can I get more?

6.2.2 Solution

So far we have focused on using PRU 0. *Mapping bit positions to pin names* shows that PRU 0 can access ten GPIO pins on the BeagleBone Black. If you use PRU 1 you can get to an additional 14 pins (if they aren't in use for other things.)

What if you need even more GPIO pins? You can access **any** GPIO pin by going through the **Open-Core Protocol** (OCP) port.

Figure 4-2. PRU-ICSS Integration

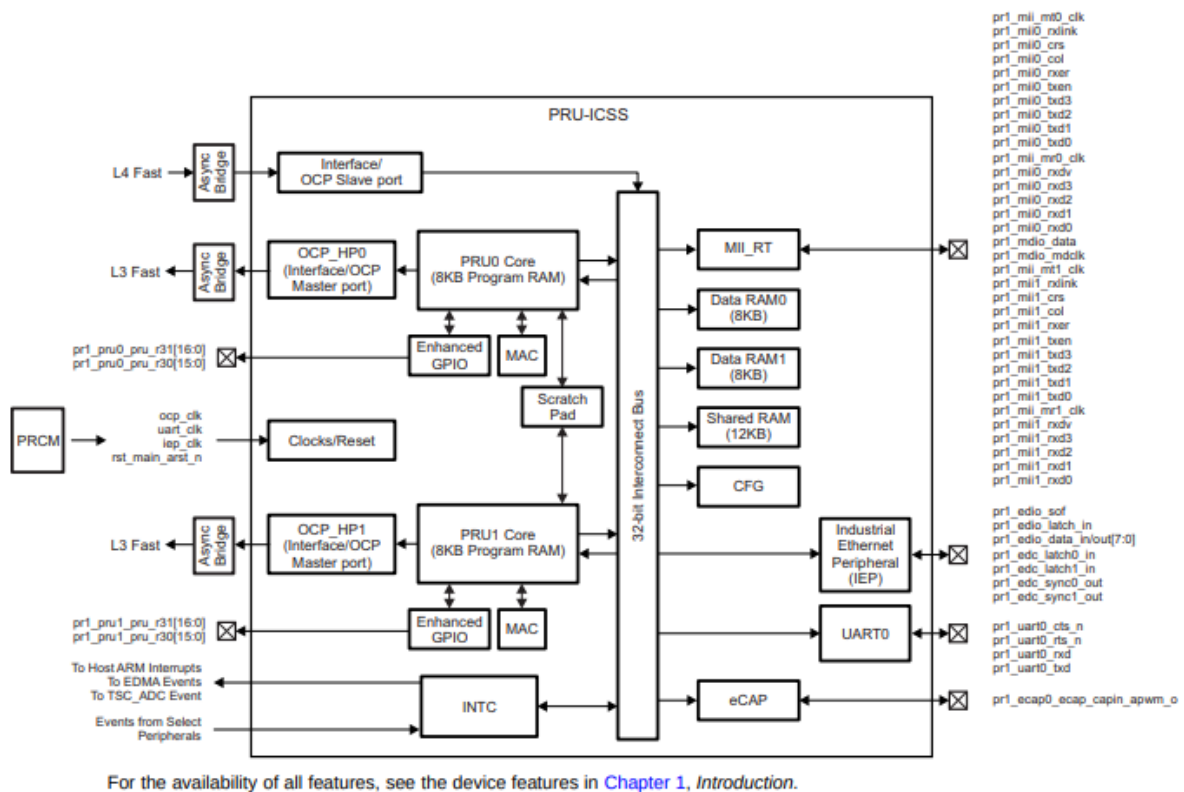

Fig. 6.1: PRU Integration

The figure above shows we've been using the **Enhanced GPIO** interface when using pass : [__] R30, but it also shows you can use the OCP. You get access to many more GPIO pins, but it's a slower access.

Listing 6.2: gpio.pru0.c

```

1 // This code accesses GPIO without using R30 and R31
2 #include <stdint.h>
3 #include <pru_cfg.h>
4 #include "resource_table_empty.h"
5 #include "prugpio.h"
6
7 #define P9_11          (0x1<<30)           // Bit position tied
8   ↳to P9_11 on Black
9 #define P2_05          (0x1<<30)           // Bit position tied
10  ↳to P2_05 on Pocket
11
12 volatile register uint32_t __R30;
13 volatile register uint32_t __R31;
14
15 void main(void)
16 {
17     uint32_t *gpio0 = (uint32_t *)GPIO0;
18
19     while(1) {
20         gpio0[GPIO_SETDATAOUT] = P9_11;
21         __delay_cycles(100000000);
22         gpio0[GPIO_CLEARDATAOUT] = P9_11;
23         __delay_cycles(100000000);
24     }
25 }

```

gpio.pru0.c

This code will toggle P9_11 on and off. Here's the setup file.

Listing 6.3: setup.sh

```

1 #!/bin/bash
2
3 export TARGET=gpio.pru0
4 echo TARGET=$TARGET
5
6 # Configure the PRU pins based on which Beagle is running
7 machine=$(awk '{print $NF}' /proc/device-tree/model)
8 echo -n $machine
9 if [ $machine = "Black" ]; then
10     echo " Found"
11     pins="P9_11"
12 elif [ $machine = "Blue" ]; then
13     echo " Found"
14     pins=""
15 elif [ $machine = "PocketBeagle" ]; then
16     echo " Found"
17     pins="P2_05"
18 else
19     echo " Not Found"
20     pins=""
21 fi
22
23 for pin in $pins
24 do
25     echo $pin
26     config-pin $pin gpio
27     config-pin -q $pin
28 done

```

```
setup.sh
```

Notice in the code `config-pin set P9_11 to gpio`, not `pruout`. This is because we are using the OCP interface to the pin, not the usual PRU interface.

Set your exports and make.

```

1 bone$ *source setup.sh*
2 TARGET=gpio.pru0
3 ...
4 bone$ *make*
5 /opt/source/pru-cookbook-code/common/Makefile:29: MODEL=TI_AM335x_BeagleBone_
   ↳Black, TARGET=gpio.pru0
6 - Stopping PRU 0
7 - copying firmware file /tmp/vsx-examples/gpio.pru0.out to /lib/firmware/
   ↳am335x-pru0-fw
8 write_init_pins.sh
9 - Starting PRU 0
10 MODEL    = TI_AM335x_BeagleBone_Black
11 PROC     = pru
12 PRUN    = 0
13 PRU_DIR  = /sys/class/remoteproc/remoteproc1

```

6.2.3 Discussion

When you run the code you see `P9_11` toggling on and off. Let's go through the code line-by-line to see what's happening.

Table 6.1: `gpio.pru0.c` line-by-line

Line	Explanation
2-5	Standard includes
5	The AM335x has four 32-bit GPIO ports. Lines 55-58 of <i>prugpio.h</i> define the addresses for each of the ports. You can find these in Table 2-2 page 180 of the AM335x TRM 180 . Look up <i>P9_11</i> in the <i>P9</i> header. Under the <i>_Mode7_</i> column you see <i>gpio0[30]</i> . This means <i>P9_11</i> is bit 30 on GPIO port 0. Therefore we will use <i>GPIO0</i> in this code. You can also run <i>gpioinfo</i> and look for <i>P9_11</i> .
5	Line 103 of <i>prugpio.h</i> defines the address offset from <i>GPIO0</i> that will allow us to <i>_clear_</i> any (or all) bits in GPIO port 0. Other architectures require you to read a port, then change some bit, then write it out again, three steps. Here we can do the same by writing to one location, just one step.
5	Line 104 of <i>prugpio.h</i> is like above, but for <i>_setting_</i> bits.
5	Using this offset of line 105 of <i>prugpio.h</i> lets us just read the bits without changing them.
7,8	This shifts <i>0x1</i> to the 30 th bit position, which is the one corresponding to <i>P9_11</i> .
15	Here we initialize <i>gpio0</i> to point to the start of GPIO port 0's control registers.
18	<i>gpio0[GPIO_SETDATAOUT]</i> refers to the <i>SETDATAOUT</i> register of port 0. Writing to this register turns on the bits where 1's are written, but leaves alone the bits where 0's are.
19	Wait 100,000,000 cycles, which is 0.5 seconds.
20	This is line 18, but the output bit is set to 0 where 1's are written.

6.2.4 How fast can it go?

This approach to GPIO goes through the slower OCP interface. If you set `pass : [__]delay_cycles(0)` you can see how fast it is.

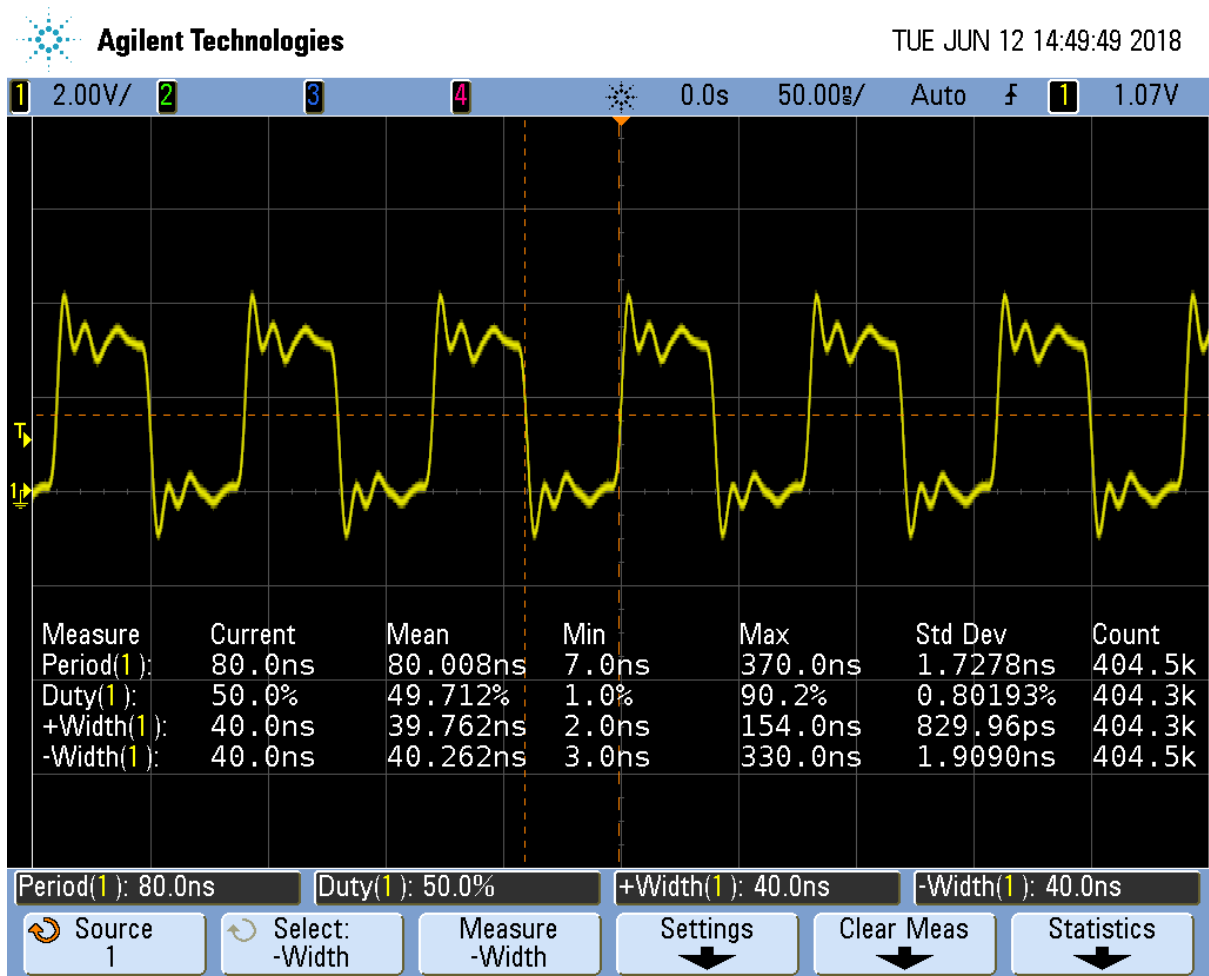

Fig. 6.2: gpio.pru0.c with pass:[_]delay_cycles(0)

The period is 80ns which is 12.MHz. That's about one fourth the speed of the `pass : [__]R30` method, but still not bad.

If you are using an oscilloscope, look closely and you'll see the following.

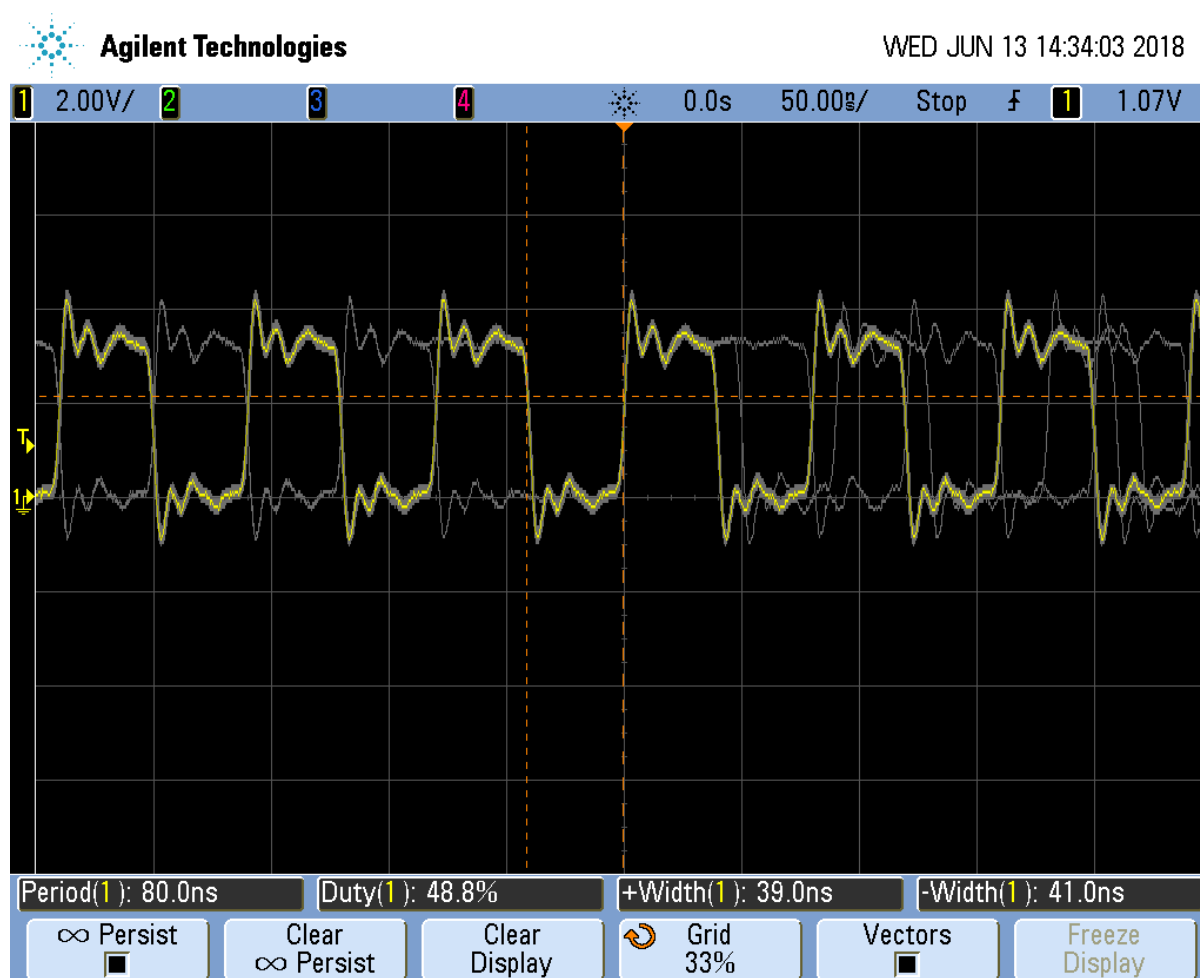

Fig. 6.3: PWM with jitter

The PRU is still as solid as before in its timing, but now it's going through the OCP interface. This interface is shared with other parts of the system, therefore the sometimes the PRU must wait for the other parts to finish. When this happens the pulse width is a bit longer than usual thus adding jitter to the output.

For many applications a few nanoseconds of jitter is unimportant and this GPIO interface can be used. If your application needs better timing, use the `pass : [__]R30` interface.

6.3 Configuring for UIO Instead of RemoteProc

6.3.1 Problem

You have some legacy PRU code that uses UIO instead of remoteproc and you want to switch to UIO.

6.3.2 Solution

Edit `/boot/uEnt.txt` and search for `uio`. I find

```
###pru_uio (4.4.x-ti, 4.9.x-ti, 4.14.x-ti & mainline/bone kernel)
uboot_overlay_pru=/lib/firmware/AM335X-PRU-UIO-00A0.dtbo
```

Uncomment the `uboot` line. Look for other lines with `uboot_overlay_pru=` and be sure they are commented out.

Reboot your Bone.

```
bone$ sudo reboot
```

Check that UIO is running.

```
bone$ lsmod | grep uio
uio_pruss          16384  0
uio_pdrv_genirq   16384  0
uio                20480  2 uio_pruss,uio_pdrv_genirq
```

You are now ready to run the legacy PRU code.

6.4 Converting pasm Assembly Code to clpru

6.4.1 Problem

You have some legacy assembly code written in `pasm` and it won't assemble with `clpru`.

6.4.2 Solution

Generally there is a simple mapping from `pasm` to `clpru`. [pasm vs. clpru](#) notes what needs to be changed. I have a less complete version on my [eLinux.org](#) site.

6.4.3 Discussion

The `clpru` assembly can be found in [PRU Assembly Language Tools](#).

Chapter 7

More Performance

So far in all our examples we've been able to meet our timing goals by writing our code in the C programming language. The C compiler does a surprisingly good job at generating code, most the time. However there are times when very precise timing is needed and the compiler isn't doing it.

At these times you need to write in assembly language. This chapter introduces the PRU assembler and shows how to call assembly code from C. Detailing on how to program in assembly are beyond the scope of this text.

The following are resources used in this chapter.

Note: *Resources*

- PRU Optimizing C/C++ Compiler, v2.2, User's Guide
 - PRU Assembly Language Tools User's Guide
 - PRU Assembly Instruction User Guide
-

7.1 Calling Assembly from C

7.1.1 Problem

You have some C code and you want to call an assembly language routine from it.

7.1.2 Solution

You need to do two things, write the assembler file and modify the Makefile to include it. For example, let's write our own `my_delay_cycles` routine in assembly. The intrinsic `pass: [__]delay_cycles` must be passed a compile time constant. Our new `delay_cycles` can take a runtime delay value.

[delay-test.pru0.c](#) is much like our other c code, but on line 10 we declare `my_delay_cycles` and then on lines 24 and 26 we'll call it with an argument of 1.

Listing 7.1: delay-test.pru0.c

```
1 // Shows how to call an assembly routine with one parameter
2 #include <stdint.h>
3 #include <pru_cfg.h>
4 #include "resource_table_empty.h"
5 #include "prugpio.h"
6
7 // The function is defined in delay.asm in same dir
```

(continues on next page)

(continued from previous page)

```

8 // We just need to add a declaration here, the definition can be
9 // separately linked
10 extern void my_delay_cycles(uint32_t);
11
12 volatile register uint32_t __R30;
13 volatile register uint32_t __R31;
14
15 void main(void)
16 {
17     uint32_t gpio = P9_31;           // Select which pin to toggle.;
18
19     /* Clear SYSCFG[STANDBY_INIT] to enable OCP master port */
20     CT_CFG.SYSCFG_bit.STANDBY_INIT = 0;
21
22     while(1) {
23         __R30 |= gpio;               // Set the GPIO pin to 1
24         my_delay_cycles(1);
25         __R30 &= ~gpio;             // Clear the GPIO pin
26         my_delay_cycles(1);
27     }
28 }

```

delay-test.pru0.c

[delay.pru0.asm](#) is the assembly code.

Listing 7.2: delay.pru0.asm

```

1 ; This is an example of how to call an assembly routine from C.
2 ;     Mark A. Yoder, 9-July-2018
3     .global my_delay_cycles
4 my_delay_cycles:
5 delay:
6     sub             r14,    r14, 1           ; The first argument_
7     ←is passed in r14
8     qbne           delay, r14, 0
9     jmp            r3.w2           ; r3 contains the_
10    ←return address

```

delay.pru0.asm

The Makefile has one addition that needs to be made to compile both [delay-test.pru0.c](#) and [delay.pru0.asm](#). If you look in the local Makefile you'll see:

Listing 7.3: Makefile

```

1 include /opt/source/pru-cookbook-code/common/Makefile

```

Makefile

This Makefile includes a common Makefile at `/opt/source/pru-cookbook-code/common/Makefile`, this the Makefile you need to edit. Edit `/opt/source/pru-cookbook-code/common/Makefile` and go to line 195.

```

$(GEN_DIR)/%.out: $(GEN_DIR)/%.o *$(GEN_DIR)/$(TARGETasm).o*
    @mkdir -p $(GEN_DIR)
    @echo 'LD    $^'
    $(eval $(call target-to-proc,$@))
    $(eval $(call proc-to-build-vars,$@))
    @$ (LD) $@ $^ $(LDFLAGS)

```

Add `*$(GEN_DIR)/$(TARGETasm).o*` as shown in bold above. You will want to remove this addition

once you are done with this example since it will break the other examples.

The following will compile and run everything.

```
bone$ config-pin P9_31 prout
bone$ make TARGET=delay-test.pru0 TARGETasm=delay.pru0
/opt/source/pru-cookbook-code/common/Makefile:29: MODEL=TI_AM335x_BeagleBone_
→Black,TARGET=delay-test.pru0
- Stopping PRU 0
- copying firmware file /tmp/vsx-examples/delay-test.pru0.out to /lib/
→firmware/am335x-pru0-fw
write_init_pins.sh
- Starting PRU 0
MODEL = TI_AM335x_BeagleBone_Black
PROC = pru
PRUN = 0
PRU_DIR = /sys/class/remoteproc/remoteproc1
```

The resulting output is shown in [Output of my_delay_cycles\(\)](#).

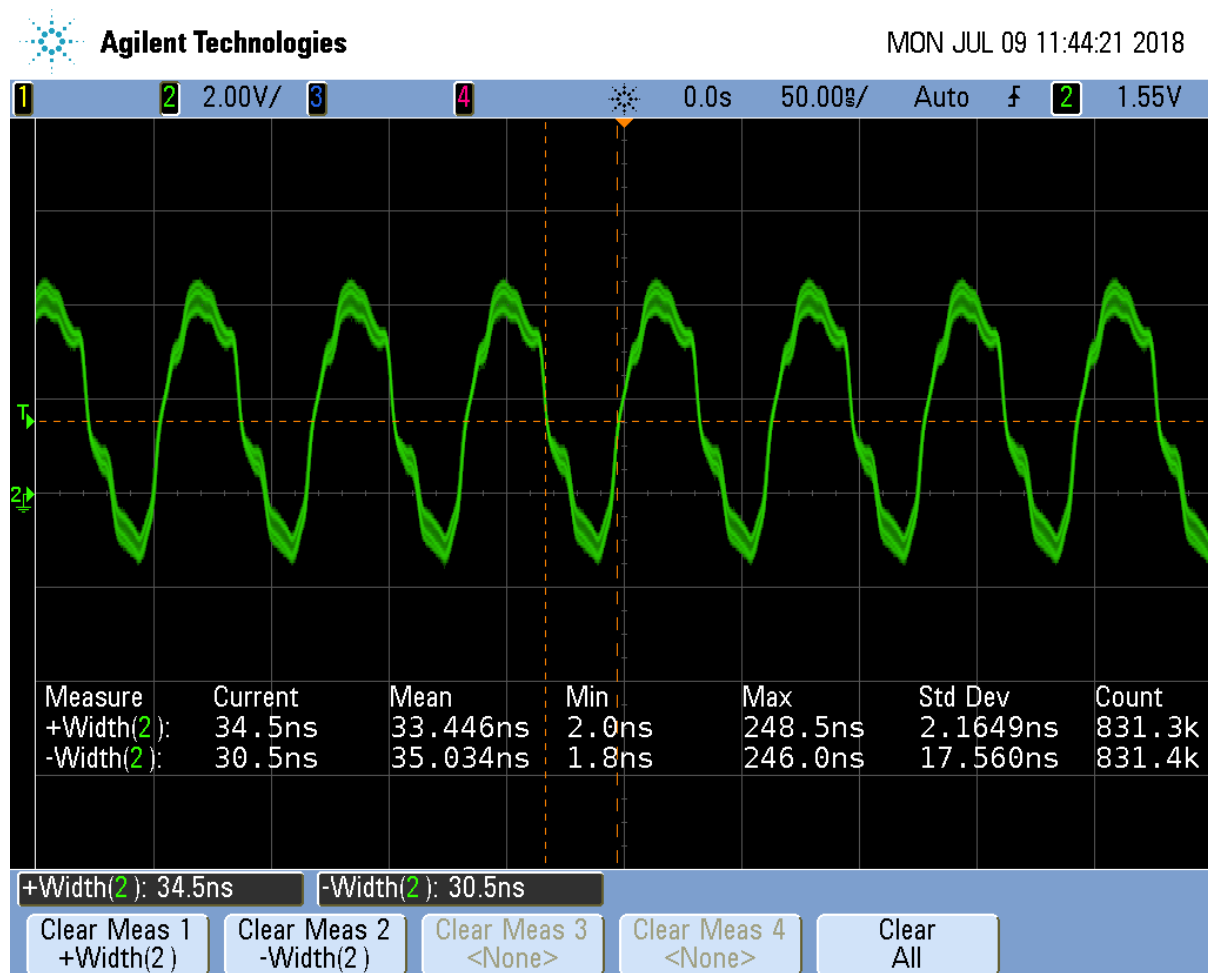

Fig. 7.1: Output of my_delay_cycles()

Notice the on time is about 35ns and the off time is 30ns.

7.1.3 Discussion

There is much to explain here. Let's start with [delay.pru0.asm](#).

Table 7.1: Line-by-line of delay.pru0.asm

Line	Explanation
3	Declare <code>my_delay_cycles</code> to be global so the linker can find it.
4	Label the starting point for <code>my_delay_cycles</code> .
5	Label for our delay loop.
6	The first argument is passed in register <code>r14</code> . Page 111 of PRU Optimizing C/C++ Compiler, v2.2, User's Guide gives the argument passing convention. Registers <code>r14</code> to <code>r29</code> are used to pass arguments, if there are more arguments, the argument stack (<code>r4</code>) is used. The other register conventions are found on page 108. Here we subtract 1 from <code>r14</code> and save it back into <code>r14</code> .
7	<code>qbne</code> is a quick branch if not equal.
9	Once we've delayed enough we drop through the quick branch and hit the jump. The upper bits of register <code>r3</code> has the return address, therefore we return to the c code.

`Output of my_delay_cycles()` shows the **on** time is 35ns and the off time is 30ns. With 5ns/cycle this gives 7 cycles on and 6 off. These times make sense because each instruction takes a cycle and you have, set `R30`, jump to `my_delay_cycles`, `sub`, `qbne`, `jmp`. Plus the instruction (not seen) that initializes `r14` to the passed value. That's a total of six instructions. The extra instruction is the branch at the bottom of the `while` loop.

7.2 Returning a Value from Assembly

7.2.1 Problem

Your assembly code needs to return a value.

7.2.2 Solution

`R14` is how the return value is passed back. `delay-test2.pru0.c` shows the c code.

Listing 7.4: delay-test2.pru0.c

```

1 // Shows how to call an assembly routine with a return value
2 #include <stdint.h>
3 #include <pru_cfg.h>
4 #include "resource_table_empty.h"
5 #include "prugpio.h"
6
7 #define TEST 100
8
9 // The function is defined in delay.asm in same dir
10 // We just need to add a declaration here, the definition can be
11 // separately linked
12 extern uint32_t my_delay_cycles(uint32_t);
13
14 uint32_t ret;
15
16 volatile register uint32_t __R30;
17 volatile register uint32_t __R31;
18
19 void main(void)
20 {
21     uint32_t gpio = P9_31; // Select which pin to toggle.;
22
23     /* Clear SYSCFG[STANDBY_INIT] to enable OCP master port */
24     CT_CFG.SYSCFG_bit.STANDBY_INIT = 0;
25
26     while(1) {

```

(continues on next page)

(continued from previous page)

```

27     __R30 |= gpio;           // Set the GPIO pin to 1
28     ret = my_delay_cycles(1);
29     __R30 &= ~gpio;        // Clear the GPIO pin
30     ret = my_delay_cycles(1);
31 }
32 }

```

delay-test2.pru0.c

[delay2.pru0.asm](#) is the assembly code.

Listing 7.5: delay2.pru0.asm

```

1 ; This is an example of how to call an assembly routine from C with a return
  ↳value.
2 ;     Mark A. Yoder, 9-July-2018
3
4     .cdecls "delay-test2.pru0.c"
5
6     .global my_delay_cycles
7 my_delay_cycles:
8 delay:
9     sub             r14,    r14, 1           ; The first argument
  ↳is passed in r14
10    qbne           delay, r14, 0
11
12    ldi             r14, TEST           ; TEST is defined in
  ↳delay-test2.c
13
14    jmp             r3.w2              ; r14 is the return
  ↳register
15
16    jmp             r3.w2              ; r3 contains the
  ↳return address

```

delay2.pru0.asm

An additional feature is shown in line 4 of [delay2.pru0.asm](#). The `.cdecls "delay-test2.pru0.c"` says to include any defines from `delay-test2.pru0.c`. In this example, line 6 of [delay-test2.pru0.c](#) `#defines` TEST and line 12 of [delay2.pru0.asm](#) reference it.

7.3 Using the Built-In Counter for Timing

7.3.1 Problem

I want to count how many cycles my routine takes.

7.3.2 Solution

Each PRU has a CYCLE register which counts the number of cycles since the PRU was enabled. They also have a STALL register that counts how many times the PRU stalled fetching an instruction. [cycle.pru0.c - Code to count cycles](#). shows they are used.

Listing 7.6: cycle.pru0.c - Code to count cycles.

```

1 // Access the CYCLE and STALL registers
2 #include <stdint.h>
3 #include <pru_cfg.h>
4 #include <pru_ctrl.h>

```

(continues on next page)

(continued from previous page)

```

5  #include "resource_table_empty.h"
6  #include "prugpio.h"
7
8  volatile register uint32_t __R30;
9  volatile register uint32_t __R31;
10
11 void main(void)
12 {
13     uint32_t gpio = P9_31;           // Select which pin to toggle.;
14
15     // These will be kept in registers and never written to DRAM
16     uint32_t cycle, stall;
17
18     // Clear SYSCFG[STANDBY_INIT] to enable OCP master port
19     CT_CFG.SYSCFG_bit.STANDBY_INIT = 0;
20
21     PRU0_CTRL.CTRL_bit.CTR_EN = 1;   // Enable cycle counter
22
23     __R30 |= gpio;                   // Set the GPIO pin to
↳1
24     // Reset cycle counter, cycle is on the right side to force the
↳compiler
25     // to put it in it's own register
26     PRU0_CTRL.CYCLE = cycle;
27     __R30 &= ~gpio;                  // Clear the GPIO pin
28     cycle = PRU0_CTRL.CYCLE;         // Read cycle and store in a register
29     stall = PRU0_CTRL.STALL;         // Ditto for stall
30
31     __halt();
32 }

```

cycle.pru0.c

7.3.3 Discussion

The code is mostly the same as other examples. `cycle` and `stall` end up in registers which we can read using prudebug. [Line-by-line for cycle.pru0.c](#) is the Line-by-line.

Table 7.2: Line-by-line for cycle.pru0.c

Line	Explanation
4	Include needed to reference <code>CYCLE</code> and <code>STALL</code> .
16	Declaring <code>cycle</code> and <code>stall</code> . The compiler will optimize these and just keep them in registers. We'll have to look at the <code>cycle.pru0.lst</code> file to see where they are stored.
21	Enables <code>CYCLE</code> .
26	Reset <code>CYCLE</code> . It ignores the value assigned to it and always sets it to 0. <code>cycle</code> is on the right hand side to make the compiler give it its own register.
28, 29	Reads the <code>CYCLE</code> and <code>STALL</code> values into registers.

You can see where `cycle` and `stall` are stored by looking into [/tmp/vsx-examples/cycle.pru0.lst Lines 113..119](#).

Listing 7.7: /tmp/vsx-examples/cycle.pru0.lst Lines 113..119

```

113     102     .dwpsn   file "cycle.pru0.c",line 23,column 2,is_stmt,isa 0
114     103;-----
↳--
115     104;   23 | PRU0_CTRL.CTRL_bit.CTR_EN = 1;   // Enable cycle counter   ↳
↳

```

(continues on next page)

(continued from previous page)

```

116     105;-----
    ↳--
117     106 0000000c 200080240002C0      LDI32    r0, 0x00022000      ;└
    ↳[ALU_PRU] |23| $O$C1
118     107 00000014 000000F1002081      LBBO     &r1, r0, 0, 4      ;└
    ↳[ALU_PRU] |23|
119     108 00000018 0000001F03E1E1      SET     r1, r1, 0x00000003  ;└
    ↳[ALU_PRU] |23|

```

cycle.pru0.lst

Here the LDI32 instruction loads the address 0x22000 into r0. This is the offset to the CTRL registers. Later in the file we see [/tmp/vsx-examples/cycle.pru0.lst Lines 146..152](#).

Listing 7.8: /tmp/vsx-examples/cycle.pru0.lst Lines 146..152

```

146     129;-----
    ↳--
147     130; 30 | cycle = PRU0_CTRL.CYCLE;      // Read cycle and store in a└
    ↳register
148     131;-----
    ↳--
149     132 0000002c 000000F10C2081      LBBO     &r1, r0, 12, 4      ;└
    ↳[ALU_PRU] |30| $O$C1
150     133          .dwpsn file "cycle.pru0.c",line 31,column 2,is_stmt,isa 0
151     134;-----
    ↳--
152     135; 31 | stall = PRU0_CTRL.STALL;      // Ditto for stall      └
    ↳

```

cycle.pru0.lst

The first LBBO takes the contents of r0 and adds the offset 12 to it and copies 4 bytes into r1. This points to CYCLE, so r1 has the contents of CYCLE.

The second LBBO does the same, but with offset 16, which points to STALL, thus STALL is now in r0.

Now fire up **prudebug** and look at those registers.

```

bone$ sudo prudebug
PRU0> r
r
Register info for PRU0
  Control register: 0x00000009
  Reset PC:0x0000 STOPPED, FREE_RUN, COUNTER_ENABLED, NOT_SLEEPING,└
    ↳PROC_DISABLED

  Program counter: 0x0012
  Current instruction: HALT

  R00: *0x00000005*      R08: 0x00000200      R16: 0x000003c6      R24:└
    ↳0x00110210
  R01: *0x00000003*      R09: 0x00000000      R17: 0x00000000      R25:└
    ↳0x00000000
  R02: 0x000000fc      R10: 0xfff4ea57      R18: 0x000003e6      R26: 0x6e616843
  R03: 0x0004272c      R11: 0x5fac6373      R19: 0x30203020      R27: 0x206c656e
  R04: 0xffffffff      R12: 0x59bfeafc      R20: 0x0000000a      R28: 0x00003033
  R05: 0x00000007      R13: 0xa4c19eaf      R21: 0x00757270      R29: 0x02100000
  R06: 0xefd30a00      R14: 0x00000005      R22: 0x0000001e      R30: 0xa03f9990
  R07: 0x00020024      R15: 0x00000003      R23: 0x00000000      R31: 0x00000000

```

So cycle is 3 and stall is 5. It must be one cycle to clear the GPIO and 2 cycles to read the CYCLE

register and save it in the register. It's interesting there are 5 stall cycles.

If you switch the order of lines 30 and 31 you'll see `cycle` is 7 and `stall` is 2. `cycle` now includes the time needed to read `stall` and `stall` no longer includes the time to read `cycle`.

7.4 Xout and Xin - Transferring Between PRUs

7.4.1 Problem

I need to transfer data between PRUs quickly.

7.4.2 Solution

The `pass : [__] xout ()` and `pass : [__] xin ()` intrinsics are able to transfer up to 30 registers between PRU 0 and PRU 1 quickly. `xout.pru0.c` shows how `xout ()` running on PRU 0 transfers six registers to PRU 1.

Listing 7.9: `xout.pru0.c`

```

1 // From: http://git.ti.com/pru-software-support-package/pru-software-support-
  ↳ package/trees/master/examples/am335x/PRU_Direct_Connect0
2 #include <stdint.h>
3 #include <pru_intc.h>
4 #include "resource_table_pru0.h"
5
6 volatile register uint32_t __R30;
7 volatile register uint32_t __R31;
8
9 typedef struct {
10     uint32_t reg5;
11     uint32_t reg6;
12     uint32_t reg7;
13     uint32_t reg8;
14     uint32_t reg9;
15     uint32_t reg10;
16 } bufferData;
17
18 bufferData dmemBuf;
19
20 /* PRU-to-ARM interrupt */
21 #define PRU1_PRU0_INTERRUPT (18)
22 #define PRU0_ARM_INTERRUPT (19+16)
23
24 void main(void)
25 {
26     /* Clear the status of all interrupts */
27     CT_INTC.SECR0 = 0xFFFFFFFF;
28     CT_INTC.SECR1 = 0xFFFFFFFF;
29
30     /* Load the buffer with default values to transfer */
31     dmemBuf.reg5 = 0xDEADBEEF;
32     dmemBuf.reg6 = 0xAAAAAAAA;
33     dmemBuf.reg7 = 0x12345678;
34     dmemBuf.reg8 = 0BBBBBBBB;
35     dmemBuf.reg9 = 0x87654321;
36     dmemBuf.reg10 = 0xCCCCCCCC;
37
38     /* Poll until R31.30 (PRU0 interrupt) is set
39      * This signals PRU1 is initialized */
40     while ((__R31 & (1<<30)) == 0) {

```

(continues on next page)

(continued from previous page)

```

41     }
42
43     /* XFR registers R5-R10 from PRU0 to PRU1 */
44     /* 14 is the device_id that signifies a PRU to PRU transfer */
45     __xout(14, 5, 0, dmemBuf);
46
47     /* Clear the status of the interrupt */
48     CT_INTC.SICR = PRU1_PRU0_INTERRUPT;
49
50     /* Halt the PRU core */
51     __halt();
52 }

```

xout.pru0.c

PRU 1 waits at line 41 until PRU 0 signals it. [xin.pru1.c](#) sends an interrupt to PRU 0 and waits for it to send the data.

Listing 7.10: xin.pru1.c

```

1 // From: http://git.ti.com/pru-software-support-package/pru-software-support-
2 package/trees/master/examples/am335x/PRU_Direct_Connect1
3 #include <stdint.h>
4 #include "resource_table_empty.h"
5
6 volatile register uint32_t __R30;
7 volatile register uint32_t __R31;
8
9 typedef struct {
10     uint32_t reg5;
11     uint32_t reg6;
12     uint32_t reg7;
13     uint32_t reg8;
14     uint32_t reg9;
15     uint32_t reg10;
16 } bufferData;
17
18 bufferData dmemBuf;
19
20 /* PRU-to-ARM interrupt */
21 #define PRU1_PRU0_INTERRUPT (18)
22 #define PRU1_ARM_INTERRUPT (20+16)
23
24 void main(void)
25 {
26     /* Let PRU0 know that I am awake */
27     __R31 = PRU1_PRU0_INTERRUPT+16;
28
29     /* XFR registers R5-R10 from PRU0 to PRU1 */
30     /* 14 is the device_id that signifies a PRU to PRU transfer */
31     __xin(14, 5, 0, dmemBuf);
32
33     /* Halt the PRU core */
34     __halt();
35 }

```

xin.pru1.c

Use prudebug to see registers R5-R10 are transferred from PRU 0 to PRU 1.

```

PRU0> r
Register info for PRU0

```

(continues on next page)

(continued from previous page)

```

Control register: 0x00000001
Reset PC:0x0000 STOPPED, FREE_RUN, COUNTER_DISABLED, NOT_SLEEPING,
↪PROC_DISABLED

Program counter: 0x0026
Current instruction: HALT

R00: 0x00000012 *R08: 0xbbbbbbbb* R16: 0x000003c6 R24:
↪0x00110210
R01: 0x00020000 *R09: 0x87654321* R17: 0x00000000 R25:
↪0x00000000
R02: 0x000000e4 *R10: 0xcccccccc* R18: 0x000003e6 R26:
↪0x6e616843
R03: 0x0004272c R11: 0x5fac6373 R19: 0x30203020 R27: 0x206c656e
R04: 0xffffffff R12: 0x59bfeafc R20: 0x0000000a R28: 0x00003033
*R05: 0xdeadbeef* R13: 0xa4c19eaf R21: 0x00757270 R29:
↪0x02100000
*R06: 0xaaaaaaaa* R14: 0x00000005 R22: 0x0000001e R30:
↪0xa03f9990
*R07: 0x12345678* R15: 0x00000003 R23: 0x00000000 R31:
↪0x00000000

PRU0> *pru 1*
pru 1
Active PRU is PRU1.

PRU1> *r*
r
Register info for PRU1
Control register: 0x00000001
Reset PC:0x0000 STOPPED, FREE_RUN, COUNTER_DISABLED, NOT_SLEEPING,
↪PROC_DISABLED

Program counter: 0x000b
Current instruction: HALT

R00: 0x00000100 *R08: 0xbbbbbbbb* R16: 0xe9da228b R24:
↪0x28113189
R01: 0xe48cdb1f *R09: 0x87654321* R17: 0x66621777 R25:
↪0xdd29ab1
R02: 0x000000e4 *R10: 0xcccccccc* R18: 0x661f83ea R26:
↪0xcf1cd4a5
R03: 0x0004db97 R11: 0xdec387d5 R19: 0xa85adb78 R27: 0x70af2d02
R04: 0xa90e496f R12: 0xbeac3878 R20: 0x048fff22 R28: 0x7465f5f0
*R05: 0xdeadbeef* R13: 0x5777b488 R21: 0xa32977c7 R29:
↪0xae96b530
*R06: 0xaaaaaaaa* R14: 0xffa60550 R22: 0x99fb123e R30:
↪0x52c42a0d
*R07: 0x12345678* R15: 0xdeb2142d R23: 0xa353129d R31:
↪0x00000000

```

7.4.3 Discussion

[xout.pru0.c Line-by-line](#) shows the line-by-line for `xout.pru0.c`

Table 7.3: xout.pru0.c Line-by-line

Line	Explanation
4	A different resource so PRU 0 can receive a signal from PRU 1.
9-16	dmemBuf holds the data to be sent to PRU 1. Each will be transferred to its corresponding register by xout ().
21-22	Define the interrupts we're using.
27-28	Clear the interrupts.
31-36	Initialize dmemBuf with easy to recognize values.
40	Wait for PRU 1 to signal.
45	pass : [__] xout () does a direct transfer to PRU 1. Page 92 of PRU Optimizing C/C++ Compiler, v2.2, User's Guide shows how to use xout(). The first argument, 14, says to do a direct transfer to PRU 1. If the first argument is 10, 11 or 12, the data is transferred to one of three scratchpad memories that PRU 1 can access later. The second argument, 5, says to start transferring with register r5 and use as many registers as needed to transfer all of dmemBuf. The third argument, 0, says to not use remapping. (See the User's Guide for details.) The final argument is the data to be transferred.
48	Clear the interrupt so it can go again.

[xin.pru1.c Line-by-line](#) shows the line-by-line for xin.pru1.c.

Table 7.4: xin.pru1.c Line-by-line

Line	Explanation
8-15	Place to put the received data.
26	Signal PRU 0
30	Receive the data. The arguments are the same as xout(), 14 says to get the data directly from PRU 0. 5 says to start with register r5. dmemBuf is where to put the data.

If you really need speed, considering using pass : [__] xout () and pass : [__] xin () in assembly.

Copyright

Listing 7.11: copyright.c

```

1  /*
2  * Copyright (C) 2015 Texas Instruments Incorporated - http://www.ti.com/
3  *
4  *
5  * Redistribution and use in source and binary forms, with or without
6  * modification, are permitted provided that the following conditions
7  * are met:
8  *
9  *     * Redistributions of source code must retain the above copyright
10 *       notice, this list of conditions and the following disclaimer.
11 *
12 *     * Redistributions in binary form must reproduce the above copyright
13 *       notice, this list of conditions and the following disclaimer in
14 *       the
15 *       documentation and/or other materials provided with the
16 *       distribution.
17 *
18 *     * Neither the name of Texas Instruments Incorporated nor the names
19 *       of
20 *       its contributors may be used to endorse or promote products
21 *       derived
22 *       from this software without specific prior written permission.
23 *
24 * THIS SOFTWARE IS PROVIDED BY THE COPYRIGHT HOLDERS AND CONTRIBUTORS
25 * "AS IS" AND ANY EXPRESS OR IMPLIED WARRANTIES, INCLUDING, BUT NOT
26 * LIMITED TO, THE IMPLIED WARRANTIES OF MERCHANTABILITY AND FITNESS FOR

```

(continues on next page)

(continued from previous page)

```
24 * A PARTICULAR PURPOSE ARE DISCLAIMED. IN NO EVENT SHALL THE COPYRIGHT
25 * OWNER OR CONTRIBUTORS BE LIABLE FOR ANY DIRECT, INDIRECT, INCIDENTAL,
26 * SPECIAL, EXEMPLARY, OR CONSEQUENTIAL DAMAGES (INCLUDING, BUT NOT
27 * LIMITED TO, PROCUREMENT OF SUBSTITUTE GOODS OR SERVICES; LOSS OF USE,
28 * DATA, OR PROFITS; OR BUSINESS INTERRUPTION) HOWEVER CAUSED AND ON ANY
29 * THEORY OF LIABILITY, WHETHER IN CONTRACT, STRICT LIABILITY, OR TORT
30 * (INCLUDING NEGLIGENCE OR OTHERWISE) ARISING IN ANY WAY OUT OF THE USE
31 * OF THIS SOFTWARE, EVEN IF ADVISED OF THE POSSIBILITY OF SUCH DAMAGE.
32 */
33
```

copyright.c

Chapter 8

Moving to the BeagleBone AI

So far all our examples have focussed mostly on the BeagleBone Black and PocketBeagle. These are both based on the am335x chip. The new kid on the block is the BeagleBone AI which is based on the am5729. The new chip brings with it new capabilities one of which is four PRUs. This chapter details what changes when moving from two to four PRUs.

The following are resources used in this chapter.

Note: *Resources*

- [AM572x Technical Reference Manual \(AI\)](#)
 - [BeagleBone AI PRU pins](#)
-

8.1 Moving from two to four PRUs

8.1.1 Problem

You have code that works on the am335x PRUs and you want to move it to the am5729 on the AI.

8.1.2 Solution

Things to consider when moving to the AI are:

- Which pins are you going to use
- Which PRU are you going to run on

Knowing which pins to use impacts the PRU you'll use.

8.1.3 Discussion

The various System Reference Manuals (SRM's) list which pins go to the PRUs. Here the tables are combined into one to make it easier to see what goes where.

Table 8.1: Mapping bit positions to pin names

PRU 0	Bit 0	Black pin P9_31	AI PRU1 pin	AI PRU2 pin P8_44	Pocket pin P1.36
0	1	P9_29	P8_41	P8_41	P1.33
0	2	P9_30		P8_42/P8_21	P2.32
0	3	P9_28	P8_12	P8_39/P8_20	P2.30
0	4	P9_92	P8_11	P8_40/P8_25	P1.31
0	5	P9_27	P9_15	P8_37/P8_24	P2.34
0	6	P9_91		P8_38/P8_5	P2.28
0	7	P9_25		P8_36/P8_6	P1.29
0	8			P8_34/P8_23	
0	9			P8_35/P8_22	
0	19			P8_33/P8_3	
0	11			P8_31/P8_4	
0	12			P8_32	
0	13			P8_45	
0	14	P8_12(out) P8_16(in)	P9_11		P2.24
0	15	P8_11(out) P8_15(in)	P8_17/P9_13		P2.33
0	16	P9_41(in) P9_26(in)	P8_27		
0	17		P9_26	P8_28	
0	18			P8_29	
0	19			P8_30	
0	20			P8_46/P8_8	
1	0	P8_45		P8_32	
1	1	P8_46	P9_20		
1	2	P8_43	P9_19		
1	3	P8_44	P9_41		
1	4	P8_41			
1	5	P8_42	P8_18	P9_25	
1	6	P8_39	P8_19	P8_9	
1	7	P8_40	P8_13	P9_31	
1	8	P8_27		P9_18	P2.35
1	9	P8_29	P8_14	P9_17	P2.01
1	10	P8_28	P9_42	P9_31	P1.35
1	11	P8_30	P9_27	P9_29	P1.04
1	12	P8_21		P9_30	
1	13	P8_20		P9_26	
1	14		P9_14	P9_42	P1.32
1	15		P9_16	P8_10	P1.30

continues on next page

Table 8.1 – continued from previous page

1	16	P9_26(in)	P8_15	P8_7
1	17		P8_26	P8_27
1	18		P8_16	P8_45
1	19			P8_46
1	19			P8_43

The pins in *bold* are already configured as pru pins. See [Seeing how pins are configured](#) to see what's currently configured as what. See [Configuring pins on the AI via device trees](#) to configure pins.

8.2 Seeing how pins are configured

8.2.1 Problem

You want to know how the pins are currently configured.

8.2.2 Solution

The `show-pins.pl` command does what you want, but you have to set it up first.

```
bone$ cd ~/bin
bone$ ln -s /opt/scripts/device/bone/show-pins.pl .
```

This creates a symbolic link to the `show-pins.pl` command that is rather hidden away. The link is put in the `bin` directory which is in the default command `$PATH`. Now you can run `show-pins.pl` from anywhere.

```
bone$ *show-pins.pl*
P9.19a          16   R6 7 fast rx  up  i2c4_scl
P9.20a          17   T9 7 fast rx  up  i2c4_sda
P8.35b          57  AD9 e fast   down gpio3_0
P8.33b          58  AF9 e fast   down gpio3_1
...
```

Here you see `P9.19a` and `P9.20a` are configured for i2c with pull up resistors. The `P8` pins are configured as gpio with pull down resistors. They are both on gpio port 3. `P8.35b` is bit 0 while `P8.33b` is bit 1. You can find which direction they are set by using `gpioinfo` and the chip number. Unfortunately you subtract one from the port number to get the chip number. So `P8.35b` is on chip number 2.

```
bone$ *gpioinfo 2*
line 0:         unnamed      unused  *input*  active-high
line 1:         unnamed      unused  *input*  active-high
line 2:         unnamed      unused  input    active-high
line 3:         unnamed      unused  input    active-high
line 4:         unnamed      unused  input    active-high
...
```

Here we see both (lines 0 and 1) are set to input.

Adding `-v` gives more details.

```
bone$ *show-pins.pl -v*
...
sysboot 14          14   H2 f fast   down sysboot14
sysboot 15          15   H3 f fast   down sysboot15
P9.19a             16   R6 7 fast rx  up  i2c4_scl
P9.20a             17   T9 7 fast rx  up  i2c4_sda
                  18   T6 f fast   down
↳Driver off
                  19   T7 f fast   down
↳Driver off
bluetooth in       20   P6 8 fast rx  uart6_rxd
↳mmc@480d1000 (wifibt_extra_pins_default)
bluetooth out      21   R9 8 fast rx  uart6_txd
↳mmc@480d1000 (wifibt_extra_pins_default)
...
```

The best way to use `show-pins.pl` is with `grep`. To see all the pru pins try:

```
bone$ *show-pins.pl | grep -i pru | sort*
P8.13          100   D3 c fast rx      pr1_pru1_gpi7
P8.15b        109   A3 d fast    down pr1_pru1_gpo16
P8.16         111   B4 d fast    down pr1_pru1_gpo18
P8.18          98   F5 c fast rx      pr1_pru1_gpi5
P8.19          99   E6 c fast rx      pr1_pru1_gpi6
P8.26         110   B3 d fast    down pr1_pru1_gpo17
P9.16         108   C5 d fast    down pr1_pru1_gpo15
P9.19b         95   F4 c fast rx    up   pr1_pru1_gpi2
P9.20b         94   D2 c fast rx    up   pr1_pru1_gpi1
```

Here we have nine pins configured for the PRU registers R30 and R31. Five are input pins and four are out.

8.3 Configuring pins on the AI via device trees

8.3.1 Problem

I want to configure another pin for the PRU, but I get an error.

```
bone$ *config-pin P9_31 prout*
ERROR: open() for /sys/devices/platform/ocp/ocp:P9_31_pinmux/state failed,␣
↳No such file or directory
```

8.3.2 Solution

The pins on the AI must be configured at boot time and therefore cannot be configured with `config-pin`. Instead you must edit the device tree.

8.3.3 Discussion

Suppose you want to make `P9_31` a PRU output pin. First go to the [am5729 System Reference Manual](#) and look up `P9_31`.

Tip: The [BeagleBone AI PRU pins](#) table may be easier to use.

`P9_31` appears twice, as `P9_31a` and `P9_31b`. Either should work, let's pick `P9_31a`.

Warning: When you have two internal pins attached to the same header (either P8 or P9) make sure only one is configured as an output. If both are outputs, you could damage the AI.

We see that when `P9_31a` is set to `MODE13` it will be a PRU **out** pin. `MODE12` makes it a PRU **in** pin. It appears at bit 10 on `PRU2_1`.

Next, find which kernel you are running.

```
bone$ uname -a
Linux ai 4.14.108-ti-r131 #1buster SMP PREEMPT Tue Mar 24 19:18:36 UTC 2020␣
↳armv7l GNU/Linux
```

I'm running the 4.14 version. Now look in `/opt/source` for your kernel.

```
bone$ cd /opt/source/
bone$ ls
adafruit-beaglebone-io-python  dtb-5.4-ti          rcpy
BBIOConfig                     librobotcontrol    u-boot_v2019.04
bb.org-overlays                 list.txt           u-boot_v2019.07-rc4
*dtb-4.14-ti*                   pyctrl
dtb-4.19-ti                     py-uio
```

`am5729-beagleboneai.dts` is the file we need to edit. Search for `P9_31`. You'll see:

```
1 DRA7XX_CORE_IOPAD(0x36DC, MUX_MODE14) // B13: P9.30: mcasp1_axr10.off //
2 DRA7XX_CORE_IOPAD(0x36D4, *MUX_MODE13*) // B12: *P9.31a*: mcasp1_axr8.off //
3 DRA7XX_CORE_IOPAD(0x36A4, MUX_MODE14) // C14: P9.31b: mcasp1_aclkx.off //
```

Change the `MUX_MODE14` to `MUX_MODE13` for output, or `MUX_MODE12` for input.

Compile and install. The first time will take a while since it recompiles all the dts files.

```
1 bone$ make
2 ...
3 DTC      src/arm/am335x-s150.dtb
4 DTC      src/arm/am5729-beagleboneai.dtb
5 DTC      src/arm/am335x-nano.dtb
6 ...
7 bone$ sudo make install
8 ...
9 'src/arm/am5729-beagleboneai.dtb' -> '/boot/dtbs/4.14.108-ti-r131/am5729-
10 ↪beagleboneai.dtb'
11 ...
12 bone$ reboot
13 ...
14 bone$ *show-pins.pl -v | sort | grep -i pru*
15 P8.13          100   D3  c  fast  rx          pr1_pru1_gpi7
16 P8.15b        109   A3  d  fast          down pr1_pru1_gpo16
17 P8.16         111   B4  d  fast          down pr1_pru1_gpo18
18 P8.18          98   F5  c  fast  rx          pr1_pru1_gpi5
19 P8.19          99   E6  c  fast  rx          pr1_pru1_gpi6
20 P8.26         110   B3  d  fast          down pr1_pru1_gpo17
21 P9.16         108   C5  d  fast          down pr1_pru1_gpo15
22 P9.19b         95   F4  c  fast  rx          up   pr1_pru1_gpi2
23 P9.20b         94   D2  c  fast  rx          up   pr1_pru1_gpi1
24 P9.31a        181  B12 d  fast          down pr2_pru1_gpo10
```

There it is. `P9_31` is now a PRU output pin on `PRU1_0`, bit 3.

8.4 Using the PRU pins

8.4.1 Problem

Once I have the PRU pins configured on the AI how do I use them?

8.4.2 Solution

In [Configuring pins on the AI via device trees](#) we configured `P9_31a` to be a PRU pin. `show-pins.pl` showed that it appears at `pr2_pru1_gpo10`, which means `pru2_1` accesses it using bit 10 of register `R30`.

8.4.3 Discussion

It's easy to modify the pwm example from [PWM Generator](#) to use this pin. First copy the example you want to modify to `pwm1.pru2_1.c`. The `pru2_1` in the file name tells the Makefile to run the code on `pru2_1`. [pwm1.pru2_1.c](#) shows the adapted code.

Listing 8.1: `pwm1.pru2_1.c`

```

1  #include <stdint.h>
2  #include <pru_cfg.h>
3  #include "resource_table_empty.h"
4  #include "prugpio.h"
5
6  #define P9_31 (0x1<<10)
7
8  volatile register uint32_t __R30;
9  volatile register uint32_t __R31;
10
11 void main(void)
12 {
13     uint32_t gpio = P9_31;           // Select which pin to toggle.;
14
15     /* Clear SYSCFG[STANDBY_INIT] to enable OCP master port */
16     CT_CFG.SYSCFG_bit.STANDBY_INIT = 0;
17
18     while(1) {
19         __R30 |= gpio;                // Set the GPIO pin to 1
20         __delay_cycles(100000000);
21         __R30 &= ~gpio;              // Clear the GPIO pin
22         __delay_cycles(100000000);
23     }
24 }

```

`pwm1.pru2_1.c`

One line 6 `P9_31` is defined as `(0x1:ref:`10)`, which means shift 1 over by 10 bits. That's the only change needed. Copy the local Makefile to the same directory and compile and run.

```
1 bone$ make TARGET=pwm1.pru2_1
```

Attach an LED to `P9_31` and it should be blinking.

Chapter 9

PRU Projects

Users of TI processors with PRU-ICSS have created application for many different uses. A list of a few are shared below. For additional support resources, software and documentation visit the PRU-ICSS wiki.

LEDscape

Description: BeagleBone Black cape and firmware for driving a large number of WS281x LED strips.

Type: Code Library Documentation and example projects.

References:

- <https://github.com/osresearch/LEDscape> <http://trmm.net/LEDscape>

LDGraphy

Description: Laser direct lithography for printing PCBs.

Type: Code Library and example project.

References:

- <https://github.com/hzeller/ldgraphy/blob/master/README.md>

PRdUino

Description: This is a port of the Energia platform based on the Arduino framework allowing you to use Arduino software libraries on PRU.

Type: Code Library

References:

- <https://github.com/lucas-ti/PRdUino>

DMX Lighting

Description: Controlling professional lighting systems

Type: Project Tutorial Code Library

References:

- <https://beagleboard.org/CapeContest/entries/BeagleBone+DMX+Cape/>

- <https://web.archive.org/web/20130921033304/blog.boxysean.com/2012/08/12/first-steps-with-the-beaglebone-pru/>
- <https://github.com/boxysean/beaglebone-DMX>

Interacto

Description: A cape making BeagleBone interactive with a triple-axis accelerometer, gyroscope and magnetometer plus a 640 x 480/30 fps camera. All sensors are digital and communicate via I²C to the BeagleBone. The camera frames are captured using the PRU-ICSS. The sensors on this cape give hobbyists and students a starting point to easily build robots and flying drones.

Type: Project 1 Project 2 Code Library

References:

- <https://beagleboard.org/CapeContest/entries/Interacto/>
- https://web.archive.org/web/20130507141634/http://www.hitchhikeree.org:80/beaglebone_capes/interacto/
- https://github.com/cclark2/interacto_bbone_cape

Replicape: 3D Printer

Description: Replicape is a high end 3D-printer electronics package in the form of a Cape that can be placed on a BeagleBone Black. It has five high power stepper motors with cool running MosFets and it has been designed to fit in small spaces without active cooling. For a Replicape Daemon that processes G-code, see the Redeem Project

Type: Project Code Library

References:

- <http://www.thing-printer.com/product/replicape/>
- <https://bitbucket.org/intelligentagent/replicape/>

PyPRUSS: Python Library

Description: PyPRUSS is a Python library for programming the PRUs on BeagleBone (Black)

Type: Code Library

References:

<https://github.com/MuneebMohammed/pypruss>

Geiger

Description: The Geiger Cape, created by Matt Ranostay, is a design that measures radiation counts from background and test sources by utilising multiple Geiger tubes. The cape can be used to detect low-level radiation, which is needed in certain industries such as security and medical.

Type: Project 1 Project 2 Code Library

References:

- <http://beagleboard.org/CapeContest/entries/Geiger+Cape/>
- <http://elinux.org/BeagleBone/GeigerCapePrototype>

Note: #TODO#: the git repo was taken down

Servo Controller Foosball Table

Description: Used for ball tracking and motor control

Type: Project Tutorial Code Library

References:

- http://www.element14.com/community/community/knode/single-board_computers/next-gen_beaglebone/blog/2013/07/17/hackerspace-challenge-leeds-only-pru-can-make-the-leds-bright
- https://docs.google.com/spreadsheet/pub?key=0AmI_ryMKXUGjdDQ3LXB4X3VBWlpxQTFWbGh6RGJHUEE&output=html
- <https://github.com/pbrook/pypruss>

Imaging with connected camera

Description: Low resolution imaging ideal for machine vision use-cases, robotics and movement detection

Type: Project Code Library

References:

- http://www.element14.com/community/community/knode/single-board_computers/next-gen_beaglebone/blog/2013/08/18/bbb-imaging-with-a-pru-connected-camera

Computer Numerical Control (CNC) Translator

Description: Smooth stepper motor control; real embedded version of LinuxCNC

Type: Tutorial Tutorial

References:

- <http://www.buildlog.net/blog/2013/09/cnc-translator-for-beaglebone/> http://bb-1cnc.blogspot.com/p/machinekit_16.html

Robotic Control

Description: Chubby SpiderBot

Type: Project Code Library Project Reference

References:

- <http://www.youtube.com/watch?v=dEes9k7-DYY>
- <http://www.youtube.com/watch?v=JXyewd98e9Q>
- <http://www.ti.com/lit/wp/spry235/spry235.pdf>

Note: #TODO#: The Chubby1_v1 repo on github.com for user cagdasc was taken down.

Software UART

Description: Soft-UART implementation on the PRU of AM335x

Type: Code Library Reference

References:

- https://software-dl.ti.com/processor-sdk-linux/esd/docs/latest/linux/Foundational_Components/PRU-ICSS/Linux_Drivers/pru-sw-uart.html

Deviant LCD

Description: PRU bit-banged LCD interface @ 240x320

Type: Project Code Library

References:

- <http://www.beagleboard.org/CapeContest/entries/DeviantLCD/>
- https://github.com/cclark2/deviantlcd_bbone_cape

Nixie tube interface

Description:

Type: Code Library

References:

- <https://github.com/mranostay/beagle-nixie>

Thermal imaging camera

Description: Thermal camera using BeagleBone Black, a small LCD, and a thermal array sensor

Type: Project Code Library

References:

- https://element14.com/community/community/knode/single-board_computers/next-gen_beaglebone/blog/2013/06/07/bbb-building-a-thermal-imaging-camera

Sine wave generator using PWMs

Description: Simulation of a pulse width modulation

Type: Project Reference Code Library

References:

- http://elinux.org/ECE497_BeagleBone_PRU
- https://github.com/millerap/AM335x_PRU_BeagleBone

Emulated memory interface

Description: ABX loads a movie into the BeagleBone's memory and then launches the memory emulator on the PRU sub-processor of the BeagleBone's ARM AM335x

Type: Project

References:

- <https://github.com/lybrown/abx>

6502 memory interface

Description: System permitting communication between Linux and 6502 processor

Type: Project Code Library

References:

- http://elinux.org/images/a/ac/What's_Old_Is_New-_A_6502-based_Remote_Processor.pdf
- <https://github.com/lybrown/abx>

JTAG/Debug

Description: Investigating the fastest way to program using JTAG and provide for debugging facilities built into the BeagleBone.

Type: Project

References:

- <http://beagleboard.org/project/PRUJTAG/>

High Speed Data Acquisition

Description: Reading data at high speeds

Type: Reference

References:

- http://www.element14.com/community/community/knode/single-board_computers/next-gen_beaglebone/blog/2013/08/04/bbb-high-speed-data-acquisition-and-web-based-ui

Prufh (PRU Forth)

Description: Forth Programming Language and Compiler. It consists of a compiler, the forth system itself, and an optional program for loading and communicating with the forth code proper.

Type: Compiler

References:

- <https://github.com/biocode3D/prufh>

VisualPRU

Description: VisualPRU is a minimal browser-based editor and debugger for the BeagleBone PRUs. The app runs from a local server on the BeagleBone.

Type: Editor and Debugger

References:

- <https://github.com/mmcddan/visualpru>

libpruio

Description: Library for easy configuration and data handling at high speeds. This library can configure and control the devices from single source (no need for further overlays or the device tree compiler)

Type: Documentation

References:

- <http://users.freebasic-portal.de/tjf/Projekte/libpruio/doc/html/index.html>
- Library <http://www.freebasic-portal.de/downloads/fb-on-arm/libpruio-325.html> [(German)]

BeagleLogic

Description: 100MHz 14channel logic analyzer using both PRUs (one to capture and one to transfer the data)

Type: Project

References:

- <http://beaglelogic.net>

BeaglePilot

Description: Uses PRUs as part of code for a BeagleBone based autopilot

Type: Code Library

References:

- <https://github.com/BeaglePilot/beaglepilot>

PRU Speak

Description: Implements BotSpeak, a platform independent interpreter for tools like Labview, on the PRUs

Type: Code Library

References:

- <https://github.com/deepakkarki/pruspeak>